

Owner's Manual

Digital Multitracker

VF80EX

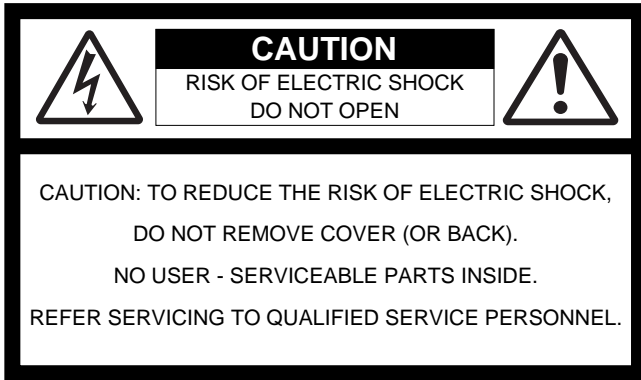



"WARNING"

"TO REDUCE THE RISK OF FIRE OR ELECTRIC SHOCK,
DO NOT EXPOSE THIS APPLIANCE TO RAIN OR
MOISTURE."

SAFETY INSTRUCTIONS

1. Read Instructions - All the safety and operating instructions should be read before the appliance is operated.
2. Retain Instructions - The safety and operating instructions should be retained for future reference.
3. Heed Warnings - All warnings on the appliance and in the operating instructions should be adhered to.
4. Follow Instructions - All operating and use instructions should be followed.
5. Water and Moisture - The appliance should not be used near water - for example, near a bathtub, washbowl, kitchen sink, laundry tub, in a wet basement, or near a swimming pool, and the like.
6. Carts and Stands - The appliance should be used only with a cart or stand that is recommended by the manufacturer.



An appliance and cart combination should be moved with care. Quick stops, excessive force, and uneven surfaces may cause the appliance and cart combination to overturn.

7. Wall or Ceiling Mounting - The appliance should be mounted to a wall or ceiling only as recommended by the manufacturer.
8. Ventilation - The appliance should be situated so that its location or position does not interfere with its proper ventilation. For example, the appliance should not be situated on a bed, sofa, rug, or similar surface that may block the ventilation openings; or, placed in a built-in installation, such as a bookcase or cabinet that may impede the flow of air through the ventilation openings.
9. Heat - The appliance should be situated away from heat sources such as radiators, heat registers, stoves, or other appliances (including amplifiers) that produce heat.

CAUTION:

TO PREVENT ELECTRIC SHOCK, MATCH WIDE BLADE OF PLUG TO WIDE SLOT, FULLY INSERT.

ATTENTION:

POUR ÉVITER LES CHOCS ÉLECTRIQUES, INTRODUIRE LA LAME LA PLUS LARGE DE LA FICHE DANS LA BORNE CORRESPONDANTE DE LA PRISE ET POUSSER JUSQU' AU FOND.



The lightning flash with arrowhead symbol, within an equilateral triangle, is intended to alert the user to the presence of uninsulated "dangerous voltage" within the product's enclosure that may be of sufficient magnitude to constitute a risk of electric shock to persons.



The exclamation point within an equilateral triangle is intended to alert the user to the presence of important operating and maintenance (servicing) instructions in the literature accompanying the appliance.

10. Power Sources - The appliance should be connected to a power supply only of the type described in the operating instructions or as marked on the appliance.
11. Grounding or Polarization - The precautions that should be taken so that the grounding or polarization means of an appliance is not defeated.
12. Power Cord Protection - Power supply cords should be routed so that they are not likely to be walked on or pinched by items placed upon or against them, paying particular attention to cords at plugs, convenience receptacles, and the point where they exit from the appliance.
13. Cleaning - The appliance should be cleaned only as recommended by the manufacturer.
14. Nonuse Periods - The power cord of the appliance should be unplugged from the outlet when left unused for a long period of time.
15. Object and Liquid Entry - Care should be taken so that objects do not fall and liquids are not spilled into the enclosure through openings.
16. Damage Requiring Service - The appliance should be serviced by qualified service personnel when:
 - A. The power supply cord or the plug has been damaged; or
 - B. Objects have fallen, or liquid has been spilled into the appliance; or
 - C. The appliance has been exposed to rain; or
 - D. The appliance does not appear to operate normally or exhibits a marked change in performance; or
 - E. The appliance has been dropped, or the enclosure damaged.
17. Servicing - The user should not attempt to service the appliance beyond that described in the operating instructions. All other servicing should be referred to qualified service personnel.
18. The appliance should be situated away from drops of water or spray of water.
19. Objects containing liquid such as vase must not be put on the appliance.
20. The appliance is not completely isolated from the power supply even if the power switch is at off position.

Precautions

About power supply

- Be sure to connect the VF80EX to the power supply specified in the Specifications section of this owner's manual. Do not use an AC outlet of any other voltage.
- Do not connect the VF80EX to the same AC outlet to which devices that could generate noise (such as a large motor or dimmer), or the devices that consume a large amount of power (such as an air conditioning system or large electric heater) are connected.
- If you use the VF80EX in an area with a different power voltage, first consult your dealer or the nearest Fostex service station. You can use the VF80EX with a power frequency of 50Hz or 60Hz.
- It is very dangerous to use a power cord that is frayed or damaged. In such a case, stop using the VF80EX immediately and ask your dealer to repair the cord.
- To avoid possible electric shock and damage to the VF80EX, avoid contact with water or other liquids, or do not handle the power plug while your hands are wet.
- To prevent possible electric shock and damage to the VF80EX, do not remove the main unit cover or reach the inside the VF80EX.
- Do not let water or other liquid, or metal objects such as pins, accidentally enter the inside of the VF80EX because this may lead to electric shock or damage. Should water enter the inside of the VF80EX, remove the power plug from AC outlet, and consult your dealer or the nearest FOSTEX service station.
- To prevent damage to the VF80EX, be sure to power on the connected devices first, then turn on the power to the VF80EX. When you remove or connect the cables to the input/output connectors on the VF80EX, make sure that the track and master faders and volume controls are set to "0."

Important!

Equipment name, electrical ratings, serial number and other information for the VF80EX, are written on bottom side.

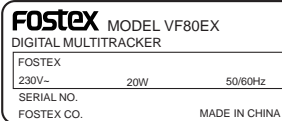

Delay of display indication

- While using the VF80EX, you may have an experience to see the delay of the reaction of the time counter or level meters. This is not a malfunction and it bears no relation to the actual sound to be recorded or played.

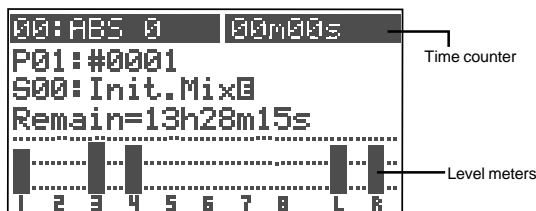

This kind of delay is due to the VF80EX design concept in which the audio processing takes priority over the display processing when the audio processing gets busy (e.g. when a sudden fader level change happens). You may always trust the VF80EX to record or playback audio in good condition.

Precautions upon handling the HD

- Before turning the power off to the VF80EX, first quit setup mode and make sure that the recorder section is stopped. Especially, never attempt to turn off the power to the VF80EX while the hard disk is accessing data (the HD ACCESS LED is lit or flashing). Otherwise, not only will you lose recorded data, but you may damage to the VF80EX. Fostex is not responsible for the data lost during operation of the VF80EX.
- Before you change the location of the VF80EX, pack the unit in the shipping carton or an impact-resistant case. Make sure that the VF80EX is kept free from external vibration or impact since the VF80EX is very sensitive to vibration.
- Do not install the VF80EX in locations subject to the following:
 - * Extremely high or low temperature, or significant changes in temperature.
 - * Excessive humidity or dust.
 - * Excessive changes in power supply voltage.
 - * Unstable or significantly vibrating or shaking surfaces.
 - * Near a strong magnetic field (such as a TV or speaker).
- If you move the unit from a place with an excessively low temperature to a warm place, or if you use the VF80EX in a room in which the temperature varies significantly during winter, condensation may occur on the hard disk or other parts. In such cases, leave the VF80EX for about an hour in the new location before you turn on the power.

Note on repair

- The VF80EX does not use any parts that user can repair easily. Contact your dealer or the nearest FOSTEX service station to ask about repairs.
- Use the packing carton designed for the VF80EX when you transport the VF80EX to the dealer for repair or return. If you have discarded the packing box, try to pack the VF80EX completely using shock absorbing materials. Fostex is not responsible for malfunction or damage due to incomplete packaging or caused during transport.

About copyrights

- It is prohibited by law to use any part of a CD recording or video images or audio data for which copyright is possessed by a third party for commercial purposes such as contents, broadcasts, sales, or distribution-any purpose other than for your personal pleasure.

About damage

- Fostex is not responsible for any "direct damage" or "indirect damage" caused by using the VF80EX.

“See this page” information by subject

The following shows reference pages where you can find information you need.
See also “The table of contents” shown on page 6.

I want to record my performance.

↓
Please read pages 28 and 30.

I want to replace a part of the previous recording with a new recording.

↓
Please read page 33.

I want to copy a part of a song to another track.

↓
Please read page 63.

I want to exchange tracks.

↓
Please read page 68.

I want to create multiple programs.

↓
Please read page 61.

I want to control the VF80EX via MIDI.

↓
Please read pages 91, 92, and 94.

I want to make my original CD.

↓
Please read page 125.

I want to record audio on a CD or MD disc to the VF80EX digitally.

↓
Please read page 91.

I want to make a backup of song data.

↓
Please read page 106.

I want to use a condenser microphone.

↓
Please read page 27.

I want to equalize the sound.

↓
Please read pages 36 and 40.

I want to operate the “Chain play mode”.

↓
Please read page 97.

I want to delete a program.

↓
Please read page 62.

I want to locate the desired position.

↓
Please read pages 32 and 59.

I want to format a hard disk.

↓
Please read page 20.

I want to mixdown tracks to an external master recorder.

↓
Please read pages 38 and 76.

I want to know details about the demonstration song.

↓
Please read page 24.

I want to know details about the internal effects.

↓
Please read page 44.

I want to save or load the mixing setting.

↓
Please read page 52.

I want to cue audio at fast speed to search the desired position.

↓
Please read page 56.

I want to scrub audio to search the desired position.

↓
Please read page 57.

I want to record or playback audio by altering the speed.

↓
Please read page 58.

I want to record audio with applying the internal effects.

↓
Please read pages 37, 45, 76 and 84.

I want to put a desired name to a program.

↓
Please read page 62.

I want to record a material while monitoring the input signal.

↓
Please read page 72.

I want to erase unnecessary songs.

↓
Please read pages 62 and 66.

I want to know details about the training mode.

↓
Please read page 74.

I want to know details about the mastering mode.

↓
Please read page 76.

I want to make track bouncing (ping-pong recording).

↓
Please read page 73.

I want to protect a recorded program.

↓
Please read page 141.

I want to save song data by the WAV file format.

↓
Please read page 119.

I want to control panning.

↓
Please read pages 36 and 40.

I want to delete unnecessary programs.

↓
Please read page 62.

I want to know details about the insert effect.

↓
Please read page 84.

I want to operate the "Audio CD playback mode".

↓
Please read page 104.

I want to save song data to a DAT.

↓
Please read page 108.

I want to make a tempo map.

↓
Please read page 136.

I want to mixdown tracks without using an external master recorder.

↓
Please read page 79.

I want to set the MTC offset time.

↓
Please read page 139.

I want to synchronize the VF80EX with an external device.

↓
Please read page 92.

I want to feed the MIDI sync signal to an external MIDI device.

↓
Please read page 138.

I want to know format information of a hard disk.

↓
Please read page 144.

I want to exchange the hard disk.

↓
Please read page 21.

I want to save song data to a CD-RW/CD-R disc.

↓
Please read page 112.

I want to copy a song recorded on a CD available on the market.

↓
Please read page 129.

I want to repeat playback of the desired part.

↓
Please read page 59.

Contents

- **Safety Instructions** 2
- **Precautions** 3
 - About power supply 3
 - Precautions upon handling the hard disk 3
 - Note on repair 3
 - About copyright 3
 - About damage 3

Basic Features of VF80EX

- **Product Features** 9
- **Before Operating** 10
 - Recording method 10
 - Program 10
 - Remain Indicator 10
 - Additional track 11
 - Input monitor and Repro monitor 11
 - Event 11
 - Trim 12
 - Time Base 12

Names and Functions

- Top panel (Analog input/output section) 14
- Top panel (Mixer section) 15
- Top panel (Recorder/display section) 16
- Rear panel 19
- Side Panel 19

About the hard disk storage device

- Reformatting the hard disk 20
- Replacing a hard disk 21
- Formatting the new hard disk 23

Basic Recording and Playback

- **About a demonstration song!** 24
- **Connections of external equipment** 25
- **LCD** 26
 - Display when turning on the power 26
 - Switching the time base 26
 - “Disk remain” indication 26
- **Preliminary knowledge** 27
 - Inputs and tracks 27
 - How to use condenser microphones 27
- **Basic recording (recording onto a single track)** 28
 - Preparation for recording 28

- Recording 29
- Playback 29

- **Basic recording (recording onto two tracks)** 30
 - Preparation for recording 30
 - Recording 31
 - Playback 31
- **Mark function** 32
 - Setting a mark on the fly 32
 - Locating a mark 32
 - Deleting a mark 32
- **ABS locate functions** 33
- **Punch in/out** 33
 - Manual punch in/out using the keys on the unit 33
 - Punch in/out using the foot switch 33
 - Auto punch in/out function 34
- **Mixing** 36
 - Adjusting levels 36
 - Setting PAN position 36
 - Adjusting EQ 36
 - Setting effects 37
- **Mixdown** 38
 - Analog mixdown 38
 - Digital mixdown 38

Mixer Functions

- **Initial condition when turning on the power** 39
- **Operations while the Normal screen is shown** . 39
 - Fader 39
 - Track mute 39
 - Master fader mute 39
- **Mix Parameter section** 40
 - Adjusting PAN positions 40
 - Editing EQ 41
 - Preset entries in the EQ library 42
 - Setting effects 44
 - How to make the loop effect setting 45
 - Setting effect send levels 46
 - Selecting an effect type 47
 - Selecting pre/post of the effect send 47
 - Turning the effect processor on or off 48
 - About the effect types 49
 - Effect parameter details 50
- **Scene memory** 52
 - Storing the current scene 52
 - Recalling a scene 52
 - Deleting a scene 53
 - Fader adjust 53

Scene sequence 54
 Assigning scene memories to the mark map 54
 Deleting a mark from the mark map 55
 Scene sequence on/off selection 55
 Executing the scene sequence 55

Recorder Functions

- **Cueing** 56
 - Cueing with the [F FWD]/[REWIND] keys** 56
 - Shuttle cueing** 56
 - Digital scrubbing** 57
 - Performing digital scrubbing 57
 - Storing the digital scrub point 57
- **Vari Pitch** 58
 - Turning on or off the vari pitch function** 58
 - Setting the speed** 58
- **Loop Function** 59
 - Setting the start and end points** 59
 - Capturing the current position on-the-fly 59
 - Editing the position via the screen 59
 - Setting the start and end points by marks 60
 - Carrying out the loop playback** 60
- **Program** 61
 - Creating a new program** 61
 - Selecting a program** 62
 - Deleting a program** 62
 - Editing a program title** 62
- **Track editing** 63
 - Copy & Paste, Move & Paste** 63
 - Performing Copy (or Move) & Paste 64
 - Undo/redo of Copy (or Move) & Paste 65
 - Erasing track data** 66
 - Erasing 66
 - Undo/redo of Erase 67
 - Track Exchange** 68
 - Performing the track exchange 68
- **Editing marks** 69
 - Viewing the mark list** 69
 - Editing a mark position** 69
 - Enter a mark title** 70
 - Adding a mark** 70
 - Deleting a mark** 71
 - Locating a mark** 71

Advanced Operations

- **Metronome function** 72
 - Setting the tempo map 72
 - Setting the metronome output 72
 - Setting the time base to bar/beat 72

Monitoring the metronome sound 72

- **Track bounce (Ping-pong recording)** 73
 - On/Off of bounce mode 73
 - Setting pan position 73
 - Setting level of each track 73
 - Performing the track bounce 73
- **Training mode** 74
 - Connecting the instrument and headphones 74
 - On/Off of training mode 74
 - Slowing down the playback speed 75
 - Changing the pitch 75
 - Canceling the center-positioned sound 75
 - Setting the cancel position 75
 - Boosting the bass sound 75
 - Playing along with the playback sound 75
- **Mastering mode** 76
 - Selecting a program to be played back 76
 - On/Off of mastering mode 76
 - Setting the mastering parameters 77
 - On/Off the mastering processing 77
 - Recording onto the master recorder 77
 - Mastering library details 77
- **Internal mastering function** 79
 - Rehearsing internal mastering** 80
 - Performing internal mastering** 81
 - About Start and End points 82
 - Checking the “Start point” and “End point” 83
 - How to add a silent part to a mastered song 83
- **Using the insert effect** 84
 - Rehearsal** 85
 - Recording the guitar** 86
 - Recording with effect** 87
 - Parameters for distortion effects (DISTORTION) ... 88
 - Parameters for distortion effects (AMP SIM.) 89
 - Parameters for distortion effects (MIC SIM.) 89
- **Digital recording** 91
 - Recording an external source onto the unit digitally** ... 91
 - Selecting a program to be recorded 91
 - Selecting the digital input 91
 - Selecting a track to record 91
 - Starting to record 91
- **MIDI clock sync system** 92
 - Connecting to external equipment 92
 - Setup of the VF80EX 93
 - Executing of recording 93
 - Confirming the MIDI clock sync 93
- **MIDI sync/MIDI machine control system** 93
 - Connecting to external equipment 94
 - Setup of external equipment 94
 - Setup of the VF80EX 94
 - Confirming MTC sync/MMC 94
 - Executing of recording 94

- **External MIDI equipment sync system by the slave mode..95**
 - Connecting to external equipment 95
 - Setup of external equipment 95
 - Setup of the VF80EX 95
 - Confirming chase lock 95
 - Executing of recording 96
- **Chain play function97**
 - Making the chain play list 98
 - Setting the chain play mode 100
 - Editing the chain play list 101
- **Audio CD playback mode104**
 - Switching the playback mode 104
 - Available functions in the audio CD playback mode 104

Save/Load of song data

- About song data 106
- Items that can be saved or loaded as song data 107

- **Save/load using the S/P DIF digital signal108**
 - Notes for digital audio recorder to be used 107
 - Notes for saving data using the S/P DIF digital signal 107

- **Saving data using the S/P DIF digital signal108**
 - Connecting to an external digital recorder 108
 - Setting the external recorder 108
 - Saving data 108

- **Loading data using the S/P DIF digital signal110**
 - Connecting to an external digital recorder 110
 - Setting the external recorder 110
 - Loading data 110

- **Save/load using CD-RW/CD-R 112**
 - Please read this first! 112
 - Care and handling of CD-RW/CD-R discs 112
 - Save/load of song data using a CD-R/RW drive .. 113

- **Saving data using a CD-R/RW drive (Backup) 114**

- **Loading backup data from a CD-R/RW drive 117**

- **Saving a WAV file 119**
 - Important notes for using a WAV file 119

- **Loading a WAV file 123**
 - Special loading method when using a computer.. 124

- **Making an audio CD 125**

- **Loading from an audio CD 129**

SETUP Mode

- **To enter the SETUP mode 134**
- **Time Signature Setting 134**
 - New Registering of Time Signature 134
 - Correcting the Registered Time Signature 135

- Deleting of Time Signature 135
- Clearing All Time Signature data 135
- Changing the Bar Offset Figure 135

- **Setting a tempo 136**
 - New Registering of Tempo 136
 - Correction of the Registered Tempo 137
 - Erasing of the Registered Tempo 137

- **Setting the Metronome function 137**

- **Setting MIDI sync output signal 138**

- **Setting an MTC frame rate 138**

- **Setting an MTC offset value 139**

- **Setting MTC offset mode 139**

- **Setting the Slave mode 140**

- **Setting the Slave type 140**

- **Setting the Record Protect function 141**

- **Setting Digital Input 142**

- **Setting BAR/BEAT Resolution mode 142**

- **Setting the MIDI device number 143**

- **Checking the number of track events 143**

- **The Drive Format Information 144**

- **Fader Fix mode Setting 144**

- **Fader Recall mode Setting 145**

Others

- **MIDI Implementation Chart 146**

- **MMC Command List 147**

- **Inquiry Message List 147**

- **Maintenance 148**

- **Specifications 148**

- **Block Diagram 149**

- **Dimensions 150**

Basic Features of VF80EX

The VF80EX Digital Multitracker incorporates a digital mixer with an 8-track (plus 16-additional track) digital recorder. The digital mixer section features a high-performance DSP multi-effect processor employing the A.S.P. (Fostex Advanced Signal Processing) technology originally developed by Fostex. The digital recorder section allows you to record and playback uncompressed linear 16-bit/44.1 kHz digital audio. You can make all process for music production such as overdubbing, track bounce, effect processing, mixdown and mastering in the digital domain without sound deterioration.

In addition, using the built-in CD-R/RW drive, you can also save/load song data to/from a CD-R or CD-RW disc, or burn an original audio CD.

Product Features

Mixer Section

- Built in a high-performance DSP multi-effect processor employing the A.S.P. (Fostex Advanced Signal Processing) technology
- 7 track faders and a stereo master fader allow you to control signal levels intuitively.
- The track ON/OFF switch is provided for each track. The 2-band EQ with the EQ library and the effect send with PRE/POST selection are provided for Tracks 1 through 6.
- Both balanced (XLR) and unbalanced (1/4" phone) connectors are provided for each analog input. The phantom power is also available when using the balanced connector. Also the trim knob on each input makes it possible to accept a wide range of input signals from microphone to line levels.
- "Bounce" function allows bouncing signals from tracks 1 through 6 to tracks 7/8 with a single key operation.
- The mastering mode allows transferring audio on the master tracks (7/8) to an external recorder with applying the EQ, reverb and compressor.
- The "REC EFFECT" function allows you to rerecord a recorded track while applying an effect (insert effect). Some distortion and simulation effects are available only for the insert effect.
- "Training mode" helps you to practice your instrument by slowing down playback, shifting the pitch of the recorded performance or masking the solo instrument / voice.
- "Scene memory" function allows you to save and load up to 99 mixer scenes including fader positions and EQ/effect settings.
- You can feed the mixed-down signal from the S/PDIF output connector to an external digital device such as a DAT recorder for digital recording.
- The "Internal Mastering" function allows you to make mastering to VF80EX's internal tracks, without the need of an external master recorder.
- Using the built-in CD-R/RW drive, you can burn an audio CD from internally mastered songs.

Recorder Section

- Employs the Fostex original FDMS-3 (Fostex Disk Management System-3) format, allowing high quality recording/playback with uncompressed linear 16-bit/44.1 kHz digital audio on 8 tracks, as well as 16 additional tracks. You can record about 3 hours of mono audio per 1 GB disk space.
- Nondestructive audio editing functions such as copy, paste, move, erase and undo/redo are possible.
- The "Program" function allows you to give a title to each song and manage up to 99 titles.
- +/- 6.0% pitch control.
- Accepts S/PDIF digital signal and records it directly onto any VF80EX track.
- The auto punch in/out function with rehearsal mode. The IN and OUT points can be set with 1/100 frame accuracy. You can also carry out punch in/out manually using the foot switch.
- The chain play function allows continuous playback of desired programs.
- Audio CD playback is possible. You can play back audio CDs created by the VF80EX (or commercially available audio CDs) using the built-in CD-R/RW drive.

Others

- Dot-matrix LCD and self-illuminating keys allow you to know the current status visually, as well as to make settings of the mixer and recorder easily.
- Durable and reliable 3.5-inch E-IDE standard hard disk is built in.
- Save/load of song data using the S/PDIF (optical) signal is possible.
- You can save/load data, as well as WAV files, to/from CD-RW or CD-R discs.
- Feeds MIDI clock with song position pointer or MTC (MIDI Time Code).
- Supports MMC (MIDI Machine Control).
- Can be slaved to an external MTC.
- The internal metronome function can be used for recording a guide track.
- The bar/beat resolution function allows editing by beat (the clock digit is omitted).
- Up to 99 mark points can be set per each song. You can locate to any mark point or make the mark map of a scene.

Before Operating

This section describes the basics that you should know before you start operating the VF80EX. All users, including those who are familiar with using tape-based Multitracker and those who are new to Multitracker, should read this section thoroughly to understand the functions of the VF80EX.

Recording method

The VF80EX uses a hard disk as a recording medium, instead of a conventional tape.

You can start recording sound sources from any point on a disk as long as the point is within the range of 24 hours in ABS time. Also you can locate to any point within the range. You may think of the VF80EX as incorporating tapes on which 24-hour time information is striped.

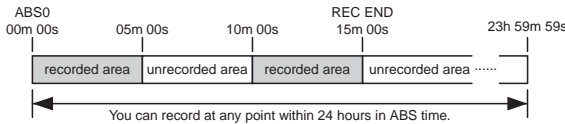

You can record in any area within 24 hours in ABS time.
 ABS 0: The beginning time at 00h 00m 00s
 REC END: The end time of recording (in the example above, 00h 15m 00s)

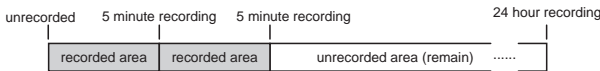

With a tape recorder, the maximum recording time depends on the tape length, regardless of the amount of unrecorded areas. With the VF80EX, you can use the media more efficiently because no disk space is used for unrecorded areas.

Program

You can use up to 99 "tapes with 24-hour time information" with the VF80EX. Each "tape" is called a "Program".

A program exists independently on the hard disk, therefore, you can freely record, playback or edit each program without affecting other programs.

You can give a name (program title) to each program, so you can easily identify a program.

"Program title" with its program number appears at the top left of the normal screen as shown below.

Program number/title ("01" is the program number while "#0001" is a default title)

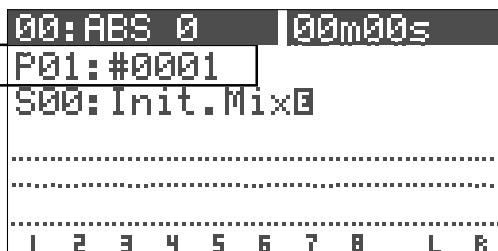

Remain indicator

The remain indicator shows how much recording time is left on the current hard disk.

The VF80EX program is managed by a 24-hour time counter, however, the actual recording time left depends on the available disk space.

The remain indicator appears on the LCD during recording (or on REC standby), showing the rough remaining time if you record on a mono track.

Note that if the remaining time is 100 hours or more, the indicator shows the available (remaining) disk space in MB.

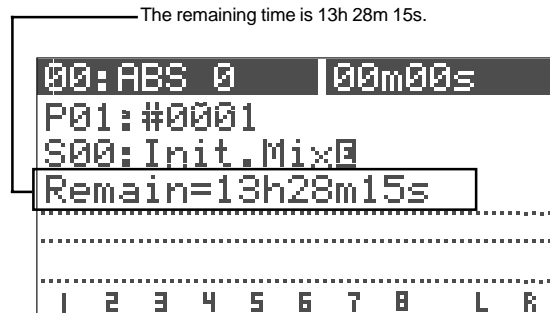

The remaining value is calculated on a mono-track basis. That is, the value indicates recordable time if you record on a mono track. You can calculate the recordable time when recording on more than one track easily by dividing the time by the track number.

In the example above, if you record on 2 tracks, the recordable time is about 6 hours 44 minutes (13 hours 28 minutes 15 seconds divided by 2). Or if you record on 8 tracks, the recordable time is about 1 hour 41 minutes (13 hours 28 minutes 15 seconds divided by 8).

The VF80EX manages up to 99 programs on the hard disk. Each program includes not only the recording data but also various setting information which consumes a small amount of disk space. Therefore, note that the remaining time shown on the screen is a rough value.

Always check the remaining time left before starting recording, to ensure that you have enough disk space to work with.

Additional track

A program on the VF80EX consists of 24 tracks. Tracks 1 through 8 are called "Real tracks" which you can record, playback and edit. Tracks 9 through 24 are called "Additional tracks". Using the "Track Exchange" function, you can exchange between "real track(s)" and "additional track(s)" in one-track, 2-track or 8-track block.

This makes it possible to record solo on several tracks, exchange tracks and compare the results, or to record different rhythm versions using multiple tracks, exchange the rhythm tracks completely and making a remix version.

Note that tracks 9 through 24 cannot be recorded, played or edited. The tracks you want to work with must be set as tracks 1 through 8.

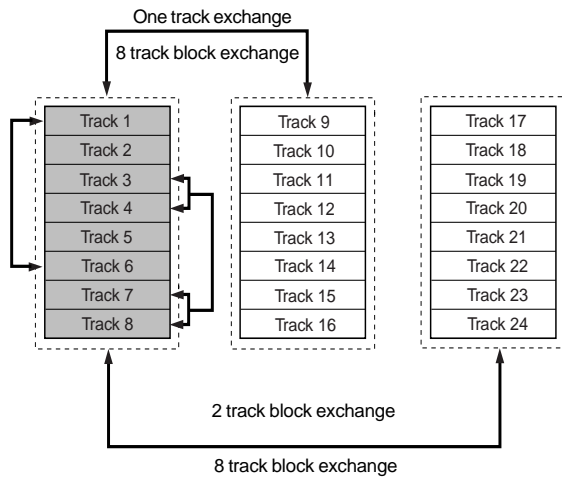

Input monitor and Repro monitor

There are two modes for monitoring a track of the VF80EX ; "Repro monitor" and "Input monitor".

"Repro monitor" means that the track playback signal is monitored.

"Input monitor" means that the input source of the track is monitored. You can check the signal level for recording in this mode.

Input monitor is only available for tracks to be recorded (on REC standby) or currently being recorded.

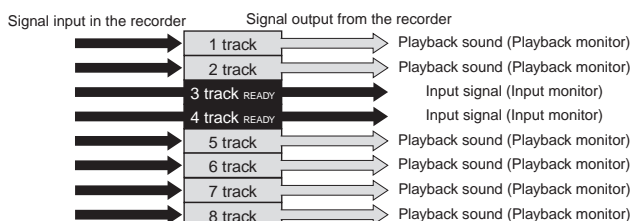

Event

Each time you make a recording, an independent audio file is created on each recorded track. A silent part on a track is also recognized as a file.

These files (audio files and silent files) are called "events".

With the VF80EX, you can create up to 512 events per track. You cannot make any further recording when 512 events are created. In the normal use, 512 events are enough.

The VF80EX can show the current number of events on the LCD. It also shows a warning message if you are going to make recording when 512 events already exist. You may resolve this problem by saving the program (see "Save/Load of a program").

Let's count the events for each recording step (A through E) below.

A. Before recording, there is a single event (silent file) on the track (the VF80EX recognizes a silent part as a file).

B. After making a recording (REC B), there are two events on the track; the recorded audio file and the following silent part.

C. After making another recording (REC C) continuously from the end point of REC B, there are three events on the track; two audio files and the following silent part.

D. After locating a point ahead of REC C and then making another recording (REC D), there are totally five events on the track. Note that a silent file is created between REC C and REC D.

E. After making a recording (REC E) over REC B and REC C, there are four events on the track.

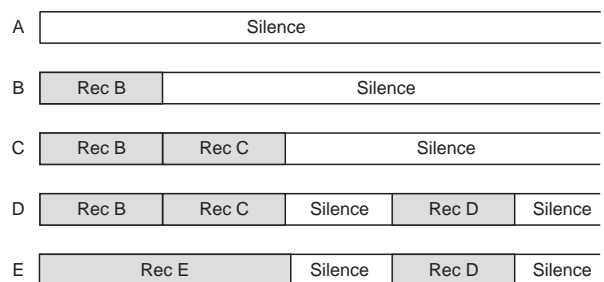

Trim

It is important to set the analog input level appropriately when converting an analog input signal from [INPUT] A or B into a digital signal (A/D conversion). You can adjust the analog level using the [TRIM] control. The [PEAK] indicator lights if the level is too high.

If the [TRIM] setting is not appropriate and the analog input level is too high (if the PEAK indicator lights), the signal will be converted into a distorted digital signal, resulting digital noise. You cannot eliminate this distortion/noise from the sound in the following stages. Therefore, be sure to adjust the level appropriately using the [TRIM] knob not to light the [PEAK] indicator when receiving the loudest audio input signal.

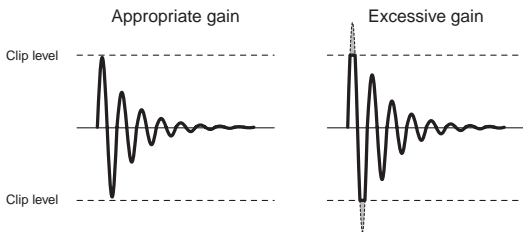

Time Base

The term "Time base" frequently appears in this manual. The time base is used to show the location in the recorder, like the "tape counter" of conventional tape recorders.

There are three types of time bases:

1. **ABS (Absolute time)**
2. **Bar/Beat/Clk (Bar/Beat/Clock)**
3. **MTC (MIDI Time Code)**

You can switch between these time bases by pressing the [TIME BASE SEL] key.

The ABS shows the absolute time of each program and is striped from 00h 00m 00s (=ABS 0) to 23h 59m 59s when a program is created.

The example below shows the current recorder position is at 00m (minute) 00s (second) 00f (frame). The hour digit appears only when the ABS time exceeds 01h 00m 00s 00f.

ABS 0 is the reference position for managing all the location and related to other time bases.



Bar/Beat/Clk shows the musical position generated from the internal tempo map of the VF80EX (including time signature and tempo).

The example below shows the current recorder position is at beat 1 of bar -2.

This position (beat 1 of bar -2) corresponds to ABS 0 and the following bar/beat numbers are determined according to the time signature and tempo settings.

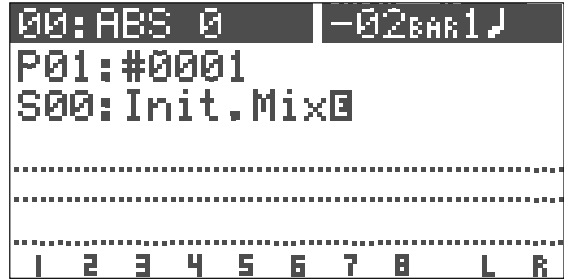

Beat 1 of bar -2 corresponds to ABS 0 as the default setting, however, you can change to set it between bar -9 and bar -2.

MTC (MIDI Time Code) runs in sync with the ABS time. The MTC value (**h **m **s) corresponding to ABS 0 can be set, which is called "MTC offset".

If you set the MTC offset to 01h 00m 00s, the MTC will start from 01h 00m 00s, and at the ABS 00h 00m 00s position, the MTC value will be 02h 00m 00s

The example below shows that the current position is at MTC 00h 59m 57s



The default MTC offset is 00h 59m 57s 00f 00sf. You can change the offset to any time value of 24-hour clock.

It is also possible to set the MTC offset by setting the MTC value corresponding to "beat 1 of bar 1" instead of "ABS 0".

The following diagram illustrates the relationship between the three time bases.

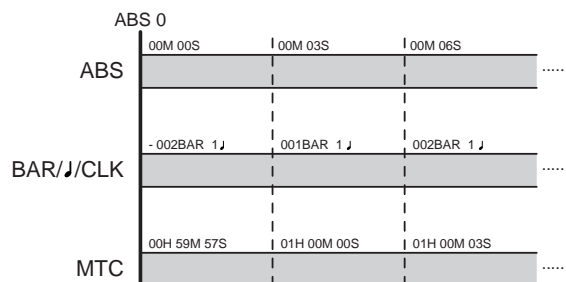

Names and Functions

Top panel



Rear panel

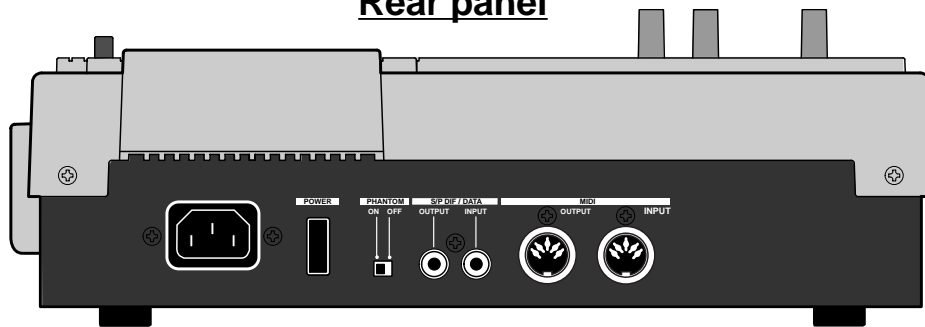

Side panel

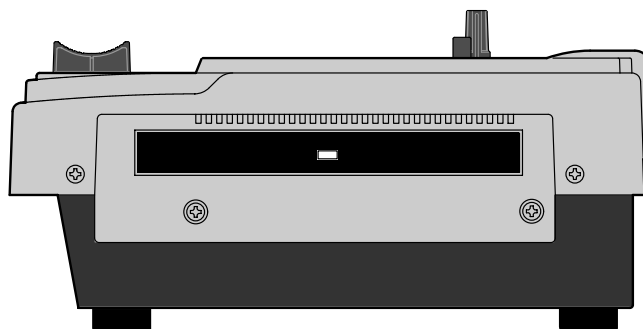

Top panel (Analog input/output section)

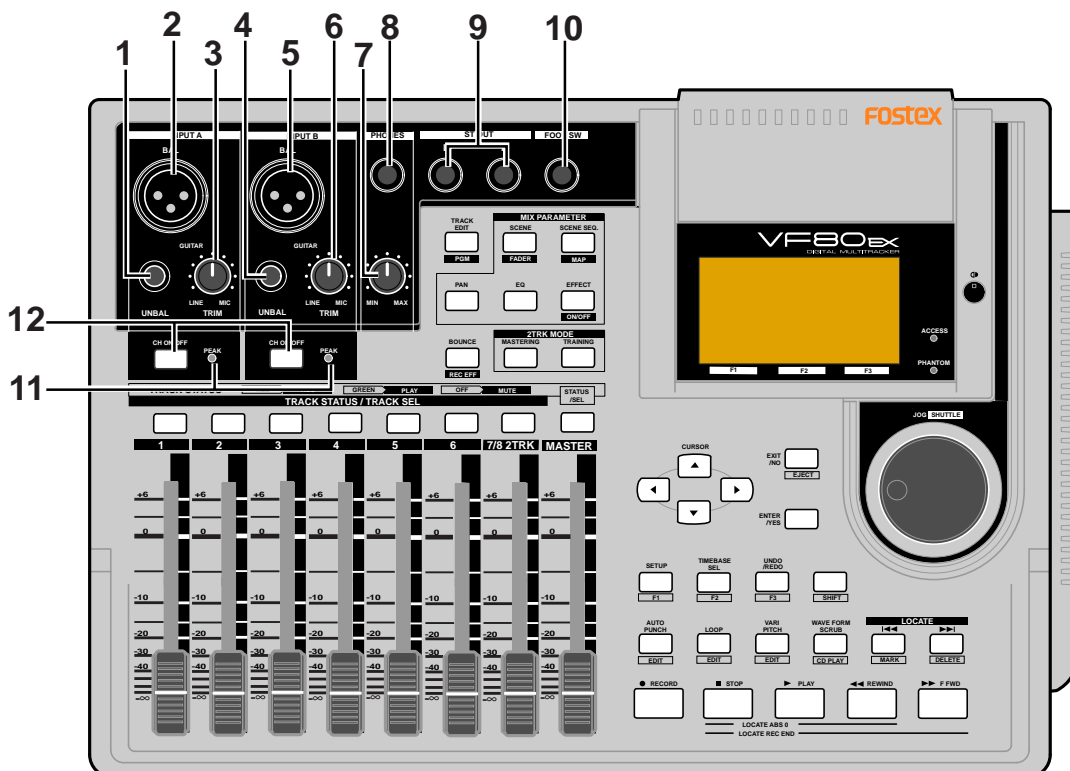

1. [INPUT A/UNBAL] (Unbalanced) connector

- Connects to the unbalanced output of an external sound source.
- Reference input level: -50 dBV to +2 dBV
- Connector type: phone jack
- When this connector is plugged, the input from the [INPUT A/BAL] connector is interrupted.

2. [INPUT A/BAL] (Balanced) connector

- Connects to the balanced output of an external sound source.
- Reference input level: -50 dBV to +2 dBV (approx. -48 dBu to +4 dBu)
- Connector type: XLR-3-31 type (pin #2 hot)
- A phantom power (+48 V) can be supplied for using a condenser microphone by setting the [PHANTOM] switch on the rear panel to ON.
- When the [INPUT A/UNBAL] connector is plugged, the input from this connector is interrupted.

3. [INPUT A/TRIM] knob

- Controls the gain according to the signal from [INPUT A].
- You can adjust the gain to accept input signals between -50 dBV (MIC) and +2 dBV (LINE).

4. [INPUT B/UNBAL] (Unbalanced) connector

- Connects to the unbalanced output of an external sound source.
- Reference input level: -50 dBV to +2 dBV
- Connector type: phone jack
- When this connector is plugged, the input from the [INPUT B/BAL] connector is interrupted.

5. [INPUT B/BAL] (Balanced) connector

- Connects to the balanced output of an external sound source.
- Reference input level: -50 dBV to +2 dBV (approx. -48 dBu to +4 dBu)
- Connector type: XLR-3-31 type (pin #2 hot)
- A phantom power (+48 V) can be supplied for using a condenser microphone by setting the [PHANTOM] switch on the rear panel to ON.
- When the [INPUT B/UNBAL] connector is plugged, the input from this connector is interrupted.

6. [INPUT B/TRIM] knob

- Controls the gain according to the signal from [INPUT B].
- You can adjust the gain to accept input signals between -50 dBV (MIC) and +2 dBV (LINE).

7. [PHONES] (Headphones) knob

- Adjusts the level of headphones for monitoring.

8. [PHONES] (Headphones) connector

- Connects headphones for monitoring.
- Connector type: TRS phone jack

9. [ST OUT L. R] (Stereo out) connector

- Outputs the stereo (L and R) buss signal.
- Connects to a master recorder, etc.
- Reference output level: -10 dBV
- Connector type: phone jack

10. [FOOT SW] (Foot switch) connector

- Connects to an optional foot switch (Model 8051) for punch in/out operation.
- Connector type: phone jack

<Caution>

Do not power on the machine with non-specified foot SW connected to the foot SW jack. When powering on the machine with non-specified foot SW (latch type foot SW, etc.) connected to the foot SW jack, there is a case that the machine does not correctly boot up with “No Drive!” alter message. In such a case, power off the machine once, disconnect the foot SW and then power back on.

11. [PEAK] indicators

- Each indicator lights up when the corresponding input signal reaches the clipping level.
- Set the [TRIM] knob properly not to light the indicator.

12. [CH ON/OFF] keys

- Each key is used to turn on and off of the corresponding channel. When on, the key illuminates.

See the following description for details about how to use each element.

Top panel (Mixer section)

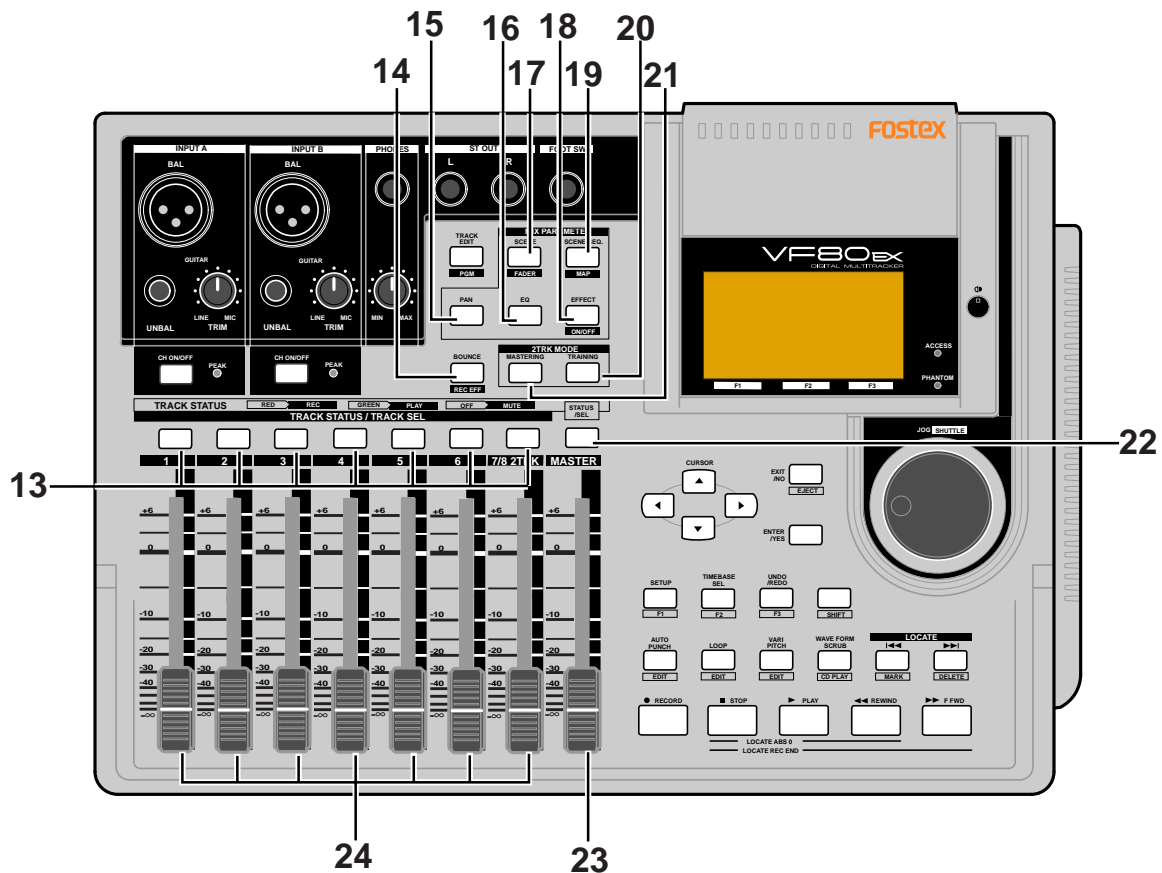

13. [TRACK STATUS/TRACK SEL] keys

- While stopped, each key is used to change the track status among OFF, PLAY and REC (READY). During playback, pressing the key switches between OFF and PLAY.
- During recording, you cannot change the track status.
- When you view or edit mixer parameters such as pan and EQ in the "Mix parameter edit" mode (described later), you can select the target track by pressing the corresponding [TRACK STATUS/TRACK SEL] key.
- The illumination of each key shows the track status as follows.
 - * flashing in red: the track is in REC READY.
 - * lighting in red: the track is being recorded.
 - * lighting in green: the track can be played back.
 - * not lighting (off): the track is muted.

14. [BOUNCE] key

- Turns the bounce mode on or off. When on (the key lights), tracks 7-8 are automatically armed for recording, allowing track 1 through 5 signals to bounce to track 7 and 8.
- Pressing this key while holding down the [SHIFT] key enters the "REC EFFECT" mode, in which rerecording a recorded track with applying the "insert effect" is possible. While the "REC EFFECT" mode is active, the [BOUNCE] key flashes in red. To exit the "REC EFFECT" mode, press the [BOUNCE] key again.

15. [MIX PARAMETER-PAN] key

- When viewing or editing the pan pot setting, press this key.
- Select the track to be viewed or edited by pressing the corresponding [TRACK STATUS/TRACK SEL] key.

Names and functions (VF80EX)

16. [MIX PARAMETER-EQ] key

- When viewing or editing the EQ setting, press this key.
- Select the track to be viewed or edited by pressing the corresponding [TRACK STATUS/TRACK SEL] key.

17. [MIX PARAMETER-SCENE / FADER] key

- When storing, recalling or deleting a scene memory, press this key.
- To view track fader positions, press this key while depressing the [SHIFT] key.

18. [MIX PARAMETER-EFFECT / ON/OFF] key

- When selecting the internal DSP effects, adjusting the effect send levels, selecting pre or post of the effect send, or setting effect parameters, press this key.
- Select the track to be viewed or edited by pressing the corresponding [TRACK STATUS/TRACK SEL] key.

19. [MIX PARAMETER-SCENE SEQ. / MAP] key

- Turns on or off the scene sequence mode.
- When editing the scene sequence map, press this key while depressing the [SHIFT] key.

20. [2TRK MODE-TRAINING] key

- Turns on or off the "Training mode" in which only tracks 7-8 are played back. When the mode is active, the key lights up.

21. [2TRK MODE-MASTERING] key

- Turns on or off the "Mastering mode" in which tracks 7-8 are played back with sound processing (the EQ, reverb and compressor). When the mode is active, the key lights up.

22. [STATUS/SEL-MASTER] key

- Turns on or off the master channel.
- Also used to select the track for the mix parameter edit.

23. [MASTER] fader

- Adjusts the output levels of the stereo L/R busses.

24. Track faders

- Adjusts the playback levels of the tracks 1 through 6 and 7-8.

Top panel (Recorder/Display section)

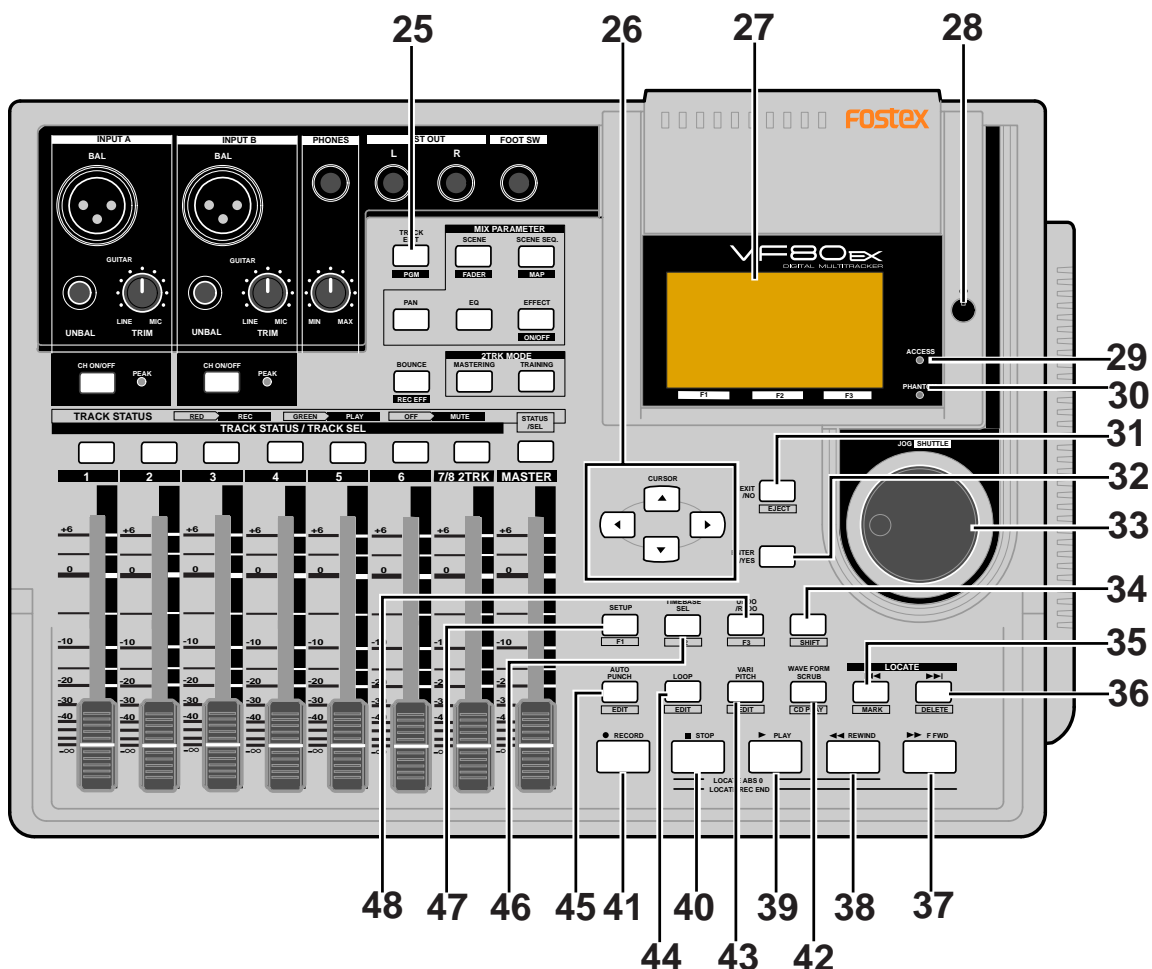

25. [TRACK EDIT / PGM] key

- When editing audio of tracks such as copy/paste, etc., press this key.
There are four audio editing functions.
 - copy
 - move
 - erase
 - track exchange
- Pressing this key while depressing the [SHIFT] key allows you to carry out the following program-related functions.
 - creating a new program
 - selecting a program
 - editing a program title
 - deleting a program

26. [CURSOR ◀/▶/▲/▼] keys

- Used to move the edit point in edit or setup mode.

27. LCD (Liquid Crystal Display)

- Displays the recorder or mixer status or parameters.

28. Contrast adjusting knob

- Adjusts the LCD contrast.
Turning the knob clockwise makes the contrast higher, while turning it counterclockwise makes it lower.

29. [ACCESS] indicator

- Lights up while the internal hard disk drive is writing or reading data.

<Caution>

Do not turn off the VF80EX power while this indicator lights. Data recorded in the disk may be erased.

30. [PHANTOM] indicator

- Lights up when the phantom power is supplied.
You can switch the phantom power on or off by the [PHANTOM] switch on the rear panel.

31. [EXIT/NO / EJECT] key

- Used to cancel or interrupt SETUP menu settings or audio editing functions such as Copy and Paste.
The opposite of the [ENTER/YES] key.

32. [ENTER/YES] key

- Used to execute SETUP menu settings or audio editing functions such as Copy and Paste. The opposite of the [EXIT/NO / EJECT] key.

33. [JOG / SHUTTLE] dial

- When the [WAVE FORM SCRUB] key is illuminated, after pressing any of the [TRACK STATUS/TRACK SEL] keys, rotating this dial scrubs audio digitally with no pitch change for both forward and backward directions.
- Used to change a parameter value in the edit mode.
- Pressing this dial while holding down the [SHIFT] key moves the position forward or backward at 1x to 64x speed depending on the rotating direction and degree.

34. [SHIFT] key

- Used to activate the second (shifted) functions of keys and a dial. Each shifted function is labeled in a white-line boxes on the panel.

35. [LOCATE |◀◀ / MARK] key

- Each press of this key locates to the previous mark point.
- Pressing this key while holding down the [SHIFT] key stores the current position in the mark map.

36. [LOCATE ▶▶ / DELETE] key

- Each press of this key locates to the next mark point.
- Pressing this key while holding down the [SHIFT] key delete the current mark point directly.

37. [F FWD ▶▶] key

- Pressing this key while stopped fast-forwards the position at 30x speed.
- Pressing this key during playback moves forward the position at 3x speed with audible cue.
- Pressing this key while holding down the [STOP] key executes the "LOCATE REC END" function (locates to the last recording position of the current program).

38. [REWIND ◀◀] key

- Pressing this key while stopped rewinds the position at 30x speed.
- Pressing this key during playback moves backward the position at 3x speed with audible cue.
- Pressing this key while holding down the [STOP] key executes the "LOCATE ABS 0" function (locates to the beginning of the current program).

39. [PLAY] key

- Pressing this key starts the recorder playback.
- Pressing the [RECORD] key while holding down this key (or pressing this key while holding down the [RECORD] key) starts recording of the armed (REC READY) track(s).
- Pressing this key alone during recording punches out (releases recording).
- Pressing this key while holding down the [STOP] key locates to the last playback position.

40. [STOP] key

- Pressing this key during playback, recording, fast-forward or rewinding stops the recorder running.
- Also used to cancel or interrupt SETUP menu settings or audio editing functions such as Copy and Paste.
- Pressing the [F FWD] or [REWIND] key while holding down this key executes the "LOCATE REC END" or "LOCATE ABS 0" function.
- Pressing the [PLAY] key while holding down this key locates to the last playback position.
- Pressing the [RECORD] key while holding down this key locates to the last recording position.

41. [RECORD] key

- Pressing the [PLAY] key while holding down this key (or pressing this key while holding down the [PLAY] key) starts recording of the armed (REC READY) track(s).
- Pressing this key alone switches the monitor of the armed track (s) to Input monitor (the [RECORD] key flashes).
Pressing this key again switches the monitor back to Repro monitor.
- Pressing this key while holding down the [STOP] key locates to the last recording position.

42. [WAVE FORM SCRUB / CD PLAY] key

- Pressing this key enters the scrub mode. In the scrub mode, you can scrub audio forward or backward digitally.
- Pressing this key while holding down the [SHIFT] key switches the playback mode between HDD playback and audio CD playback.

43. [VARI PITCH / EDIT] key

- Pressing this key switches between On and Off of the vari pitch (vari-speed playback/recording) function. When the function is active, this key is illuminated.
- Pressing this key while holding down the [SHIFT] key makes you ready to edit the pitch value via the screen.

44. [LOOP / EDIT] key

- Pressing this key switches between On and Off of the loop mode. When the mode is active, this key is illuminated.
- Pressing this key while holding down the [SHIFT] key makes you ready to edit the loop parameters (Start point and End point) via the screen.

45. [AUTO PUNCH I/O / EDIT] key

- Pressing this key switches between On and Off of the auto punch mode. When the mode is active, this key is illuminated.
- Pressing this key while holding down the [SHIFT] key makes you ready to edit the auto punch parameters (In point and Out point) via the screen.

46. [TIME BASE SEL / F2] key

- Pressing this key switches the time base shown on the screen among the following.

a. ABS (absolute time):

Absolute time from 00h00m00s to 23h59m59s.

b. Bar/Beat/Clk (Bar/Beat/Clock):

Bar/Beat/Clock according to the time signature and tempo information set in the internal tempo map.

c. MTC (MIDI Time Code)

MTC with or without an offset to the ABS time.

- When a key icon is shown above "F2" on the screen, pressing this key while holding down the [SHIFT] key executes the function directly.

47. [SETUP / F1] key

- Pressing this key enters the setup mode for editing/setting the initial setting parameters of recorder and mixer.
- When a key icon is shown above "F1" on the screen, pressing this key while holding down the [SHIFT] key executes the function directly.

48. [UNDO/REDO / F3] key

- Pressing this key cancels the operation for the audio editing (Copy, Paste, etc.), auto punch in/out or recording, and returns to the previous condition. This is the "undo" function.
- Pressing this key again returns to the condition before carrying out the "undo" function. This is the "redo" function.
- When a key icon is shown above "F3" on the screen, pressing this key while holding down the [SHIFT] key executes the function directly.

In the example below, pressing the [SETUP / F1] key, [TIME BASE SEL / F2] key or [UNDO/REDO / F3] key executes "RECALL", "STORE" or "DELETE" respectively.

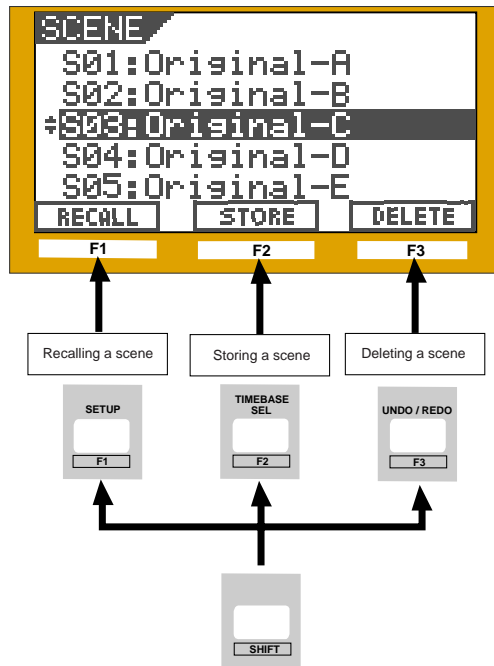

Rear panel

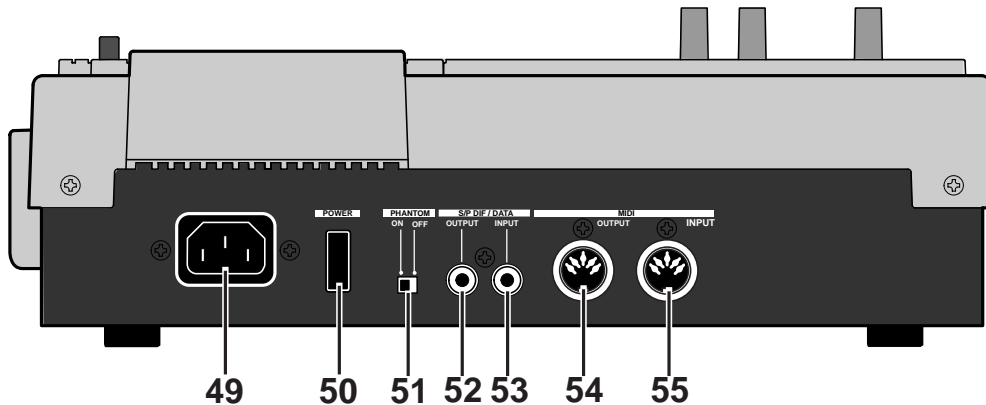
**49. [AC IN] connector**

- Connects the supplied AC power cord. Make sure that the voltage of your AC outlet matches the specified voltage.

50. [POWER] switch

- Turns on or off the power of the unit.

51. [PHANTOM] ON/OFF switch

- When the switch is set to ON, the phantom power is supplied to the condenser microphone(s) connected to the [INPUT A/BAL] and/or the [INPUT B/BAL] connector(s).

52. [S/P DIF / DATA OUTPUT] connector

- Outputs the S/P DIF digital signal. Used to connect to the coaxial (S/P DIF) digital input of an external digital device.
If the external device only provides the optical digital input, use the Fostex COP-1 coaxial/optical converter.
- Connector: RCA pin jack

53. [S/P DIF / DATA INPUT] connector

- Accepts the S/P DIF digital signal. Used to connect to the coaxial (S/P DIF) digital output of an external digital device. If the external device only provides the optical digital output, use the Fostex COP-1 coaxial/optical converter.
- Connector: RCA pin jack

54. [MIDI OUTPUT] connector

- Connects to the MIDI IN connector of an external MIDI device.
- Mainly transmits MIDI information for synchronization such as MTC (MIDI Time Code) and MIDI clock with song position pointer.
- Connector: DIN 5-pin type

55. [MIDI INPUT] connector

- Connects to the MIDI OUT connector of an external MIDI device.
- Mainly receives MIDI control information such as MMC (MIDI Machine Control).
- Connector: DIN 5-pin type

See an appropriate section for the detailed information of each operation or function.

Side panel

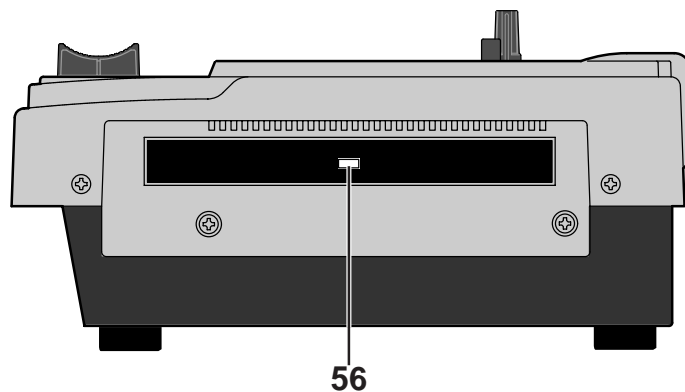
**56. CD-R/RW drive**

- After turning the power on, pressing the eject key in the front of the drive opens the tray. To close the tray, push the front of the tray lightly by your hand.

Using the CD-R/RW drive, you can also save/load song data to/from a CD-R or CD-RW disc, or burn an original audio CD.

About the hard disk storage device

The VF80EX is complete with a 3.5-inch E-IDE hard disk (storage device) which is formatted in the Master 8 mode. Therefore, there is no need to newly assemble a hard disk or to format the hard disk.

Reformatting the hard disk

This section describes how to reformat the hard disk. The VF80EX adopts a “FDMS-3 (Fostex Disk Management System-3)” format which is a Fostex exclusive format. 24 additional tracks can be used in addition to recording and playing 8-tracks of uncompressed 44.1kHz/16 bit high quality sound.

<Precaution>

Note that, when you reformat your hard disk, you will erase all data saved or recorded on the hard disk, as well as all the settings made. Reformating your hard disk restore the VF80EX back to the default setting. Always make a point to check that there is no data that you need remaining on the hard disk prior to reformating.

1 Turn ON the VF80EX.

2 Press the [SETUP] key.

The system will go to the SETUP mode. The select display of the SETUP menu appears. (The highlight indicates the menu that is currently selected.)

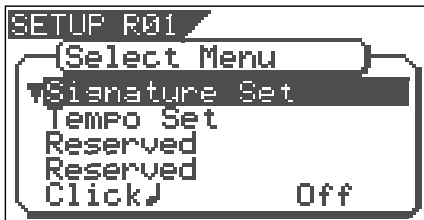

3 Turn the [JOG] dial to highlight the “Disk Format” menu title, press the [ENTER/YES] key.

“IDE” indicates the current drive.

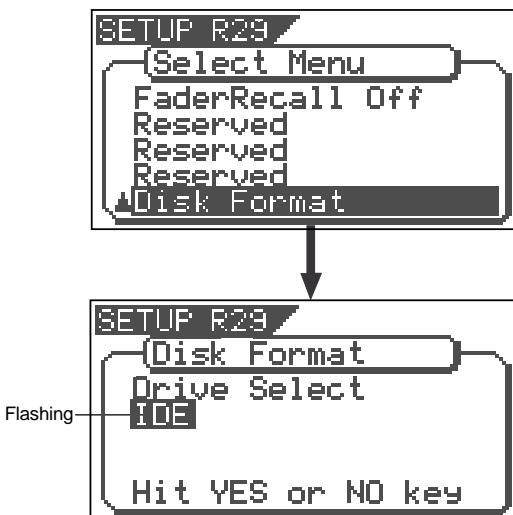

4 Press the [ENTER/YES] key while “IDE” is flashed.

The menu to select the format type appears. The display will appear as follows, according to the previous format type. “*****” represents the name of the drive.

The hard disk formatted in the “Standard” type upon newly formatting the hard disk will show “Standard” and “Erase”. The hard disk formatted in the “Quick” type upon newly formatting the hard disk will show “Standard” and “Quick”. The user can select one.

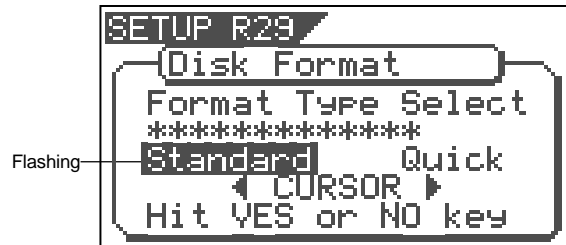

or

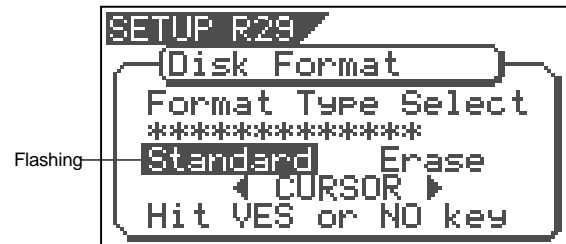

“Standard”	The hard disk is formatted with the access time of the unit sectors, while judging whether the sectors are good or bad. The formatting time tends to be longer with this type, however, the reliability is better. Therefore, it is recommended that this default format type is selected under normal conditions.
“Erase”	This choice is only available when a hard disk previously formatted in the “Standard” type is being reformatted. With this format, the “Standard” type is maintained, while all data on the hard disk are erased. The formatting time is shorter than the time required to format a “Standard” type.
“Quick”	This is a quick formatting procedure in which all hard disk sectors are considered to be good sectors. The formatting time is fast, however, the procedure cannot discover bad sectors. Therefore, it is recommended that this format type is only used when formatting a new hard disk that Fostex has already confirmed to operate normally.

- 5** Select the format type with the [CURSOR ◀/▶] key. Then press the [ENTER/YES] key.
The format type selected is set and “Sure?” flashes.

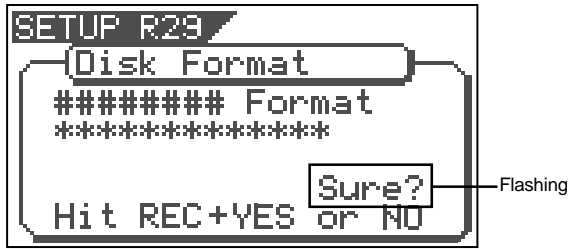

- 6** Press the [ENTER/YES] key while the [RECORD] key is depressed.
If the “Standard” format is selected and executed, the formatting process takes place while showing the progress of the good sectors (Good ***MB) on the disk, bad sectors on the disk (Bad ***MB) and remainder (Remain ***MB).
Nothing can be done during the formatting process. Please wait for a while until the process is completed.

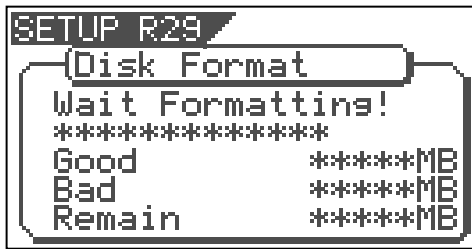

When the hard disk is successfully formatted (formatting completed), the number of sectors and noncontiguous sectors are shown after formatted, then “Completed!” lights up. Formatting is completed instantaneously if either “Erase” or “Quick” is selected and executed.
For this reason, the “Completed!” message lights up without showing the progress status while formatting is taking place.

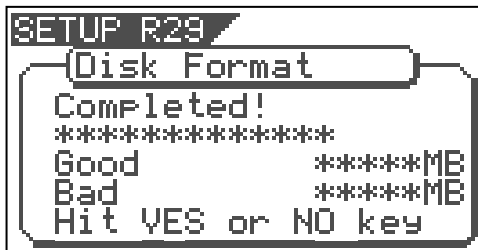

- 7** Press the [EXIT/NO] key (or [STOP] key) to escape from the SETUP mode.
The Normal Screen appears indicating the beginning of the program (P01) that is automatically created after formatting the hard disk.

Replacing a hard disk

The user can immediately start recording with the VF80EX. Note that the current hard disk can also be replaced with another model for use with the VF80EX. (However, please only use hard disks that Fostex recommends.)

<Operation Confirmed HD List for the VF80EX>

The updated information on the operation-confirmed HD and backup media for VF80EX is mentioned in the following Fostex international web site.

<http://www.fostex.co.jp/int/index.htm>

For those who are unable to check our web site, please contact the Fostex distributor in your territory.

<Warning>

This section describes the procedures to replace the hard disk. However, we recommended that the customer ask the Fostex Customer Service Department to replace the VF80EX hard disk. Note that the product is not warranted for any malfunctions that may occur after the customer replaces the hard disk on their own. Also note that Fostex will not be held liable for any accidents that may occur during the replacement process or any hard disk damages, if the customer decides to replace their own hard disk on their own.

<Precautions Upon Replacement>

- Always turn OFF the power of the VF80EX and unplug the power plug from the electric outlet when replacing the hard disk.
- Always place the hard disk on a flat and stable platform during the replacement process. Place a soft cloth under the unit to protect the product from scratching. Gloves are recommended to prevent any hand injuries.

<Precautions Upon Handling the Hard Disk>

- A hard disk is an extremely sensitive precision device. Never expose the hard disk to “strong shocks” when replacing, assembling or handling. Never leave the hard disk by a device that generates strong magnetic fields.
- Always set the DIP switch and Jumper of the newly assembled hard disk to the “Cable Select” setting. The hard disk will not operate normally if the setting is set to “Slave” or “Master” when the hard disk is assembled. Refer to the *User’s Manual* of the hard disk for more details on the DIP switch and Jumper settings.
- Note that the connector of some hard disks may be stiff, and thus make it difficult or impossible to insert or connect. Never apply excessive force to insert the connector in such case. Always make a point to gently insert the connector. Failure to do so may result in unexpected injuries or damage the hard disk.

About the hard disk storage device (VF80EX)

- 1** Unscrew the four screws from the bottom of the main unit that are fixing the panel.

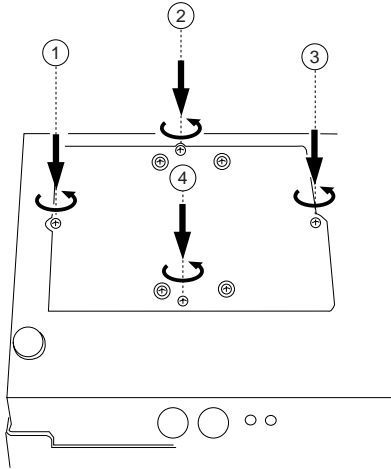

- 2** Turn over the panel that the hard disk is fixed according to the instructions shown in the figure below. Note that hard disk cables will be connected. Be careful not to apply excessive force when turning over the panel.

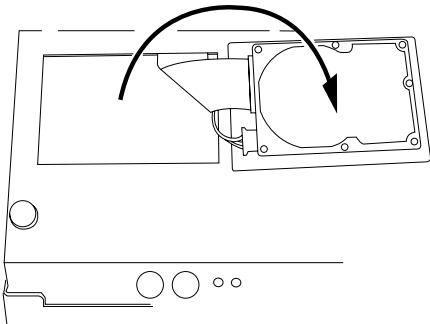

- 3** Remove the two cable connectors that are connected to the hard disk. Gently hold the connector and slowly pull out.

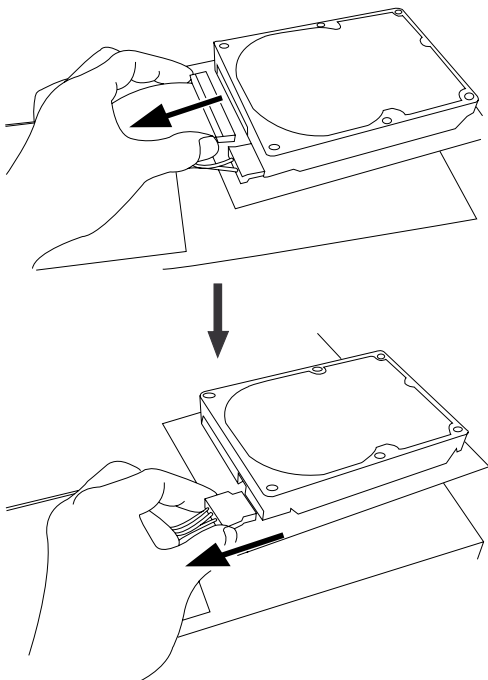

- 4** After disconnecting the cables, remove the panel that is fixing the hard disk.

Unscrew the four screws with a screwdriver, as shown in the Figure.

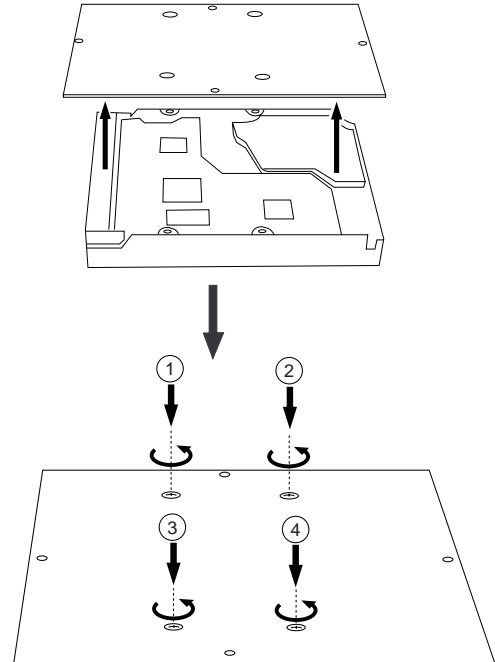

- 5** Fix a new hard disk to the panel in the reverse order of removing the hard disk as performed earlier. Connect the cables. Then house the hard disk at the bottom of the main unit.

Follow the <Precautions> described earlier, and properly assemble the parts.

When the new hard disk is successfully assembled, go to the next section. Now, format the unformatted hard disk.

Formatting the Hard disk

Carefully follow the instructions below to newly format the hard disk properly.

- 1 Turn ON the VF80EX after plugging the power cable in the electric outlet.

The VF80EX will startup. "Unformat!" will appear on the LCD. The menu will automatically go to the SETUP mode.

The display showing the "Disk Format" menu appears.

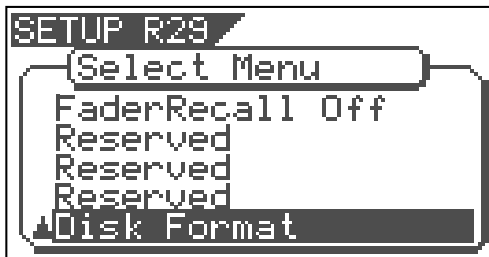

- 2 Press the [ENTER/YES] key.
 The drive selection display appears.
 "IDE" will be flashed.

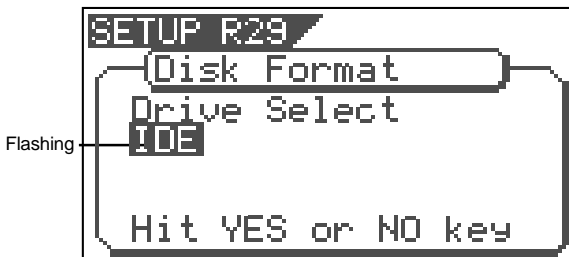

- 3 Press the [ENTER/YES] key where the "IDE" is flashed.
 The menu to select the format type appears.
 "*****" represents the name of the drive.

<CAUTION>

Either the "Standard" or "Quick" format type can be selected. However, make sure that the "Standard" format type is selected when formatting a newly installed hard disk.

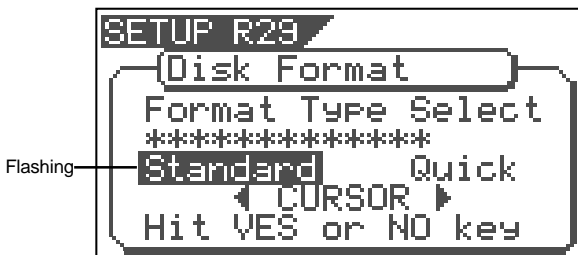

- 4 Press the [ENTER/YES] key where the "Standard" is flashed.

The format type selected is set and "Sure?" flashes.

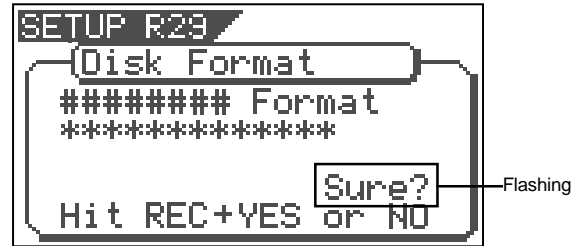

- 5 Press the [ENTER/YES] key while the [RECORD] key is depressed.

The formatting process is started. The formatting process will take some time.

When the formatting is successfully completed, "Completed!" will light up on the display.

- 6 Press the [EXIT/NO] key (or [STOP] key) to escape from the SETUP mode.

The Normal Screen appears indicating the beginning of the program (P01) that is automatically created after formatting the hard disk.



<Normal Screen>

Basic Recording and Playback

This chapter describes the basics of recording and playback audio using the VF80EX.

Before carrying out recording/playback, read “About a demonstration song!”, “Connections of external equipment”, “Preliminary knowledge” and “LCD”.

About a demonstration song!

Your VF80EX may have a demonstration song on program 1 (P01) when shipped (note that some VF80EX units may not have a demonstration song, depending on the production). Please check whether a demonstration song is recorded or not on your unit according the following manner.

<To check whether a demonstration song is recorded or not>

After turning on the unit and booting up program 1, press the [PLAY] key to start playback.

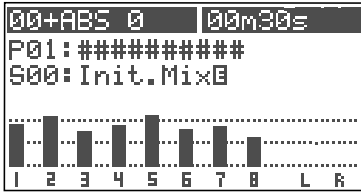

• If the level meters move:
A demonstration song is recorded.
Title of the recorded demonstration song will be indicated for the program title.

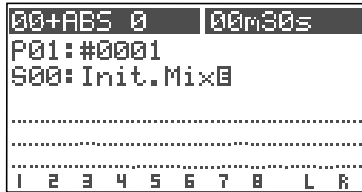

• If the level meters do not move:
No demonstration song is recorded.
Temporary title such as "#0001" will be indicated for the program title.

If a demonstration song is recorded, you can listen to the song any time by playing back program 1 (see page 28 for details about how to play back a program).

Note that you cannot record a new material on program 1 if a demonstration song is recorded on program 1. Therefore, before starting recording for the first time, you must carry out any of the following operations.

Note: You can start recording without the need for carrying out any of the following operations if no demonstration song is recorded on your unit.

If you wish to start recording while keeping the demonstration song

Create a new program.

The newly created program is not record-prohibited, so you can record a material onto it.

See page “61” for details about how to create a new program.

If you wish to record a material on program 1 (overwriting the demonstration song)

Set "Rec Protect" menu in the setup mode to "Off".

Now you can overwrite the demonstration song on program 1 by a new material.

See page “141” for details about how to make the record-protect setting to "Off".

If you wish to record a material onto program 1 after deleting the demonstration song

Delete program 1.

After deleting program 1, a new blank "program 1" is automatically created onto which you can record a new material.

See page “62” for details about how to delete a program.

Connections of external equipment

You can connect various sound sources and external devices to the input and output connectors of the VF80EX as shown in the example below. When making connection, make sure that the **[MASTER]** fader is set to the lowest (“∞”) position and the **[PHONES]** knob to the left most (“MIN”) position. Otherwise, your speakers or headphones may damage by the audio noise generated when connecting cables.

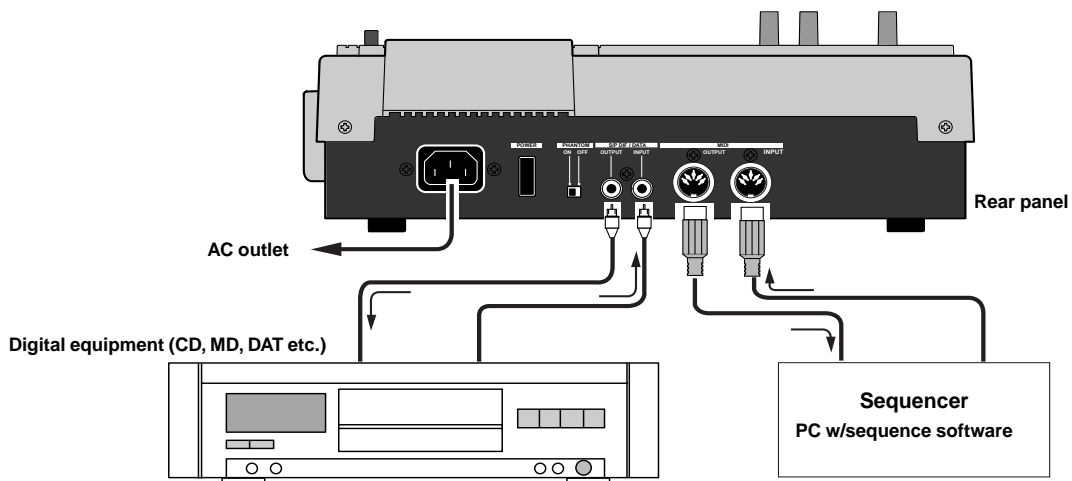
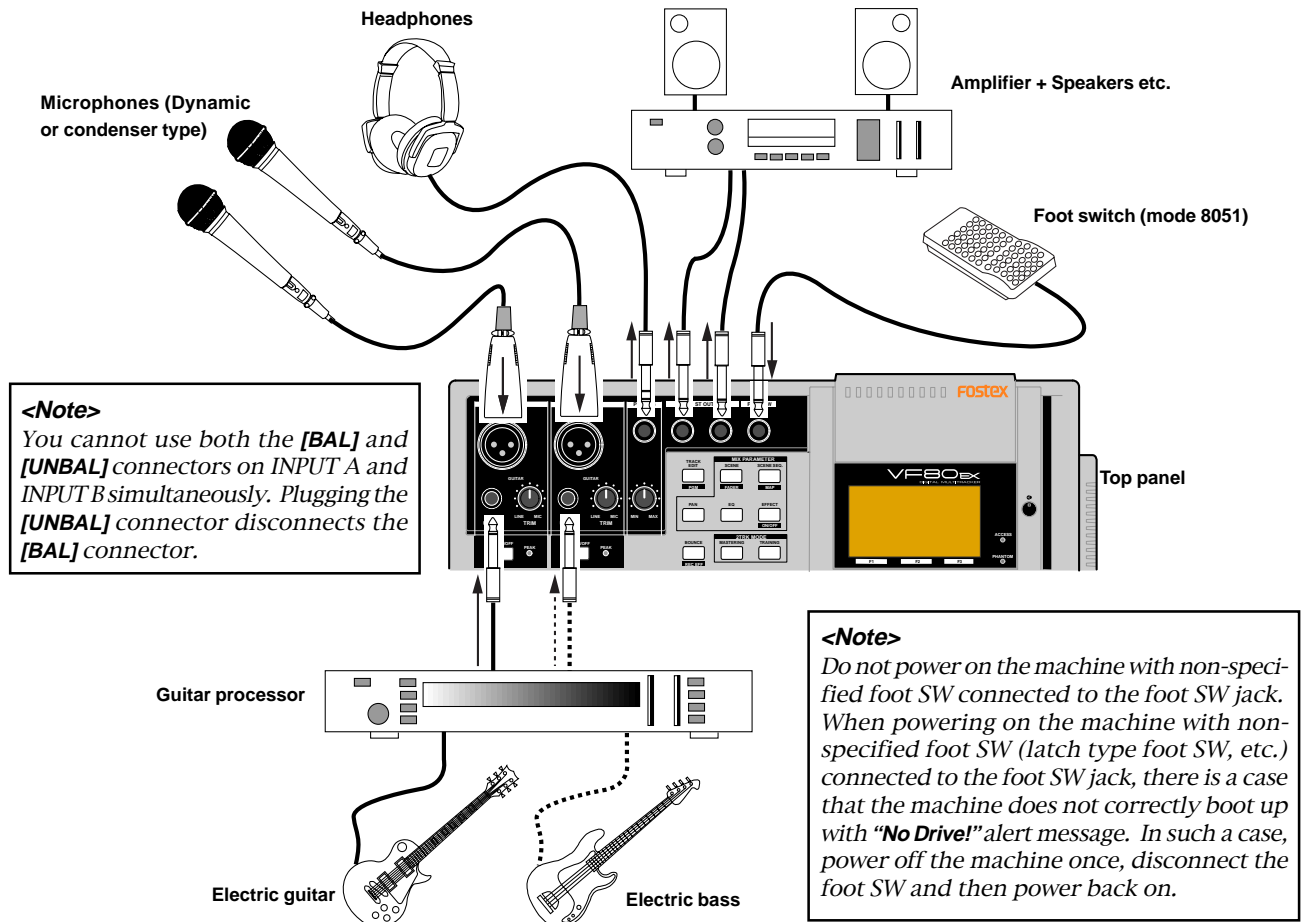

LCD

This section describes major contents on the LCD display and their operations.

Display when turning on the power

When turning on the power of the VF80EX on which a formatted hard disk is installed, the unit starts up and “Initial..” and “version number” appears on the LCD display, followed by “Current Dr”, “IDE”, “hard disk name (momentarily)” and “record mode (Standard or Quick)”. Then the unit gets ready at the beginning (ABS 0) of the program which was selected when the power was turned off last time. The current position is shown by the time base previously selected. The display that appears when the unit gets ready is call “Normal screen”. The Normal screen shows the following items.



Screen example while starting up

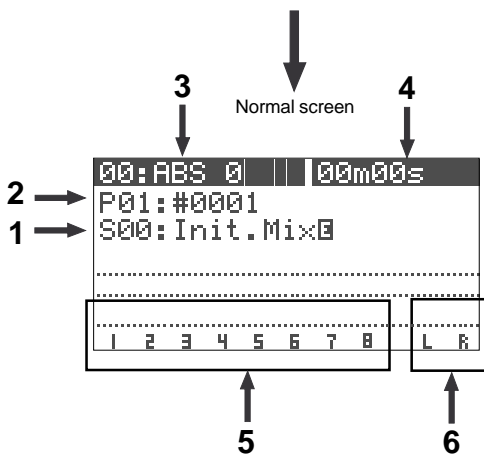

1. Scene number & name

With the initial setting, “S00: Initial Mix” appears.

2. Program number & name

With the initial setting, “P01: #0001” (#0001 is a tentative name) appears.

3. Mark number & name

With the initial setting, “00: ABS0” appears, showing that the current location is at the beginning of the program. When the recorder starts running, “:” between the number and name is replaced with “+”.

4. Time base

With the initial setting, the ABS time base is selected. You can change the time base by using the [TIME BASE SEL] key (see the next section).

5. Level meters for Tracks 1 through 8

6. Master level meters for the Stereo output (L, R)

Switching the time base

Each press of the [TIME BASE SEL] key cycles the time base of the Normal screen between “ABS”, “BAR/BEAT/CLK” and “MTC”.

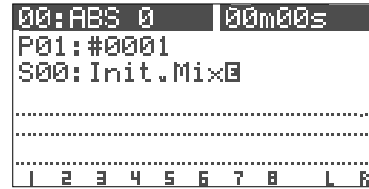

Normal screen with ABS time base

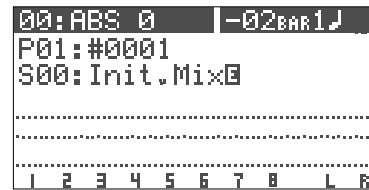

Normal screen with BAR/BEAT/CLK time base

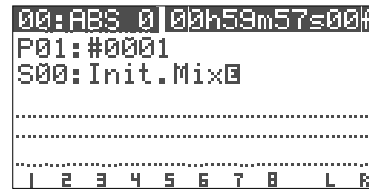

Normal screen with MTC time base

“Disk remain” indication

You can check the disk remaining space which shows the “recordable space left on the current disk”.

The disk remaining space (REM) is shown during “Rec ready” or “Recording”, in “time” when the remaining time is less than 100 hours, or in “MB (Megabyte)” of the remaining space when it exceeds 100 hours.

Note that the remaining time is shown as the recordable time when you record onto a single track.

You can calculate the recordable time for recording onto 8 tracks by dividing the displayed remaining time by 8.

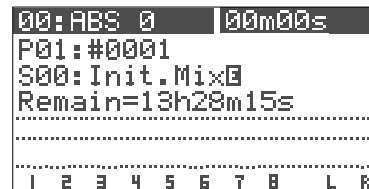

Remaining time displayed in time

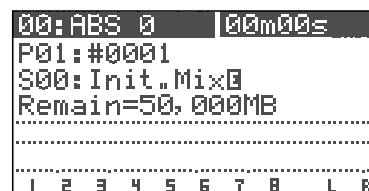

Remaining time displayed in MB

Preliminary knowledge

• Inputs and tracks

You can record onto adjacent two tracks (Tracks 1-2, 3-4, 5-6, or 7-8) or a mono track (one of Tracks 1 through 6). You cannot select another combination.

The input signal from [INPUT A] is fed to odd tracks (1, 3, 5 and 7), while the input signal from [INPUT B] is fed to even tracks (2, 4, 6 and 8). Because each input signal is directly fed to appropriate tracks, you cannot tailor the signal when recording. However, you can add reverb or equalize the sound during mixdown, or rerecord a track sound later with applying a distortion-type effect.

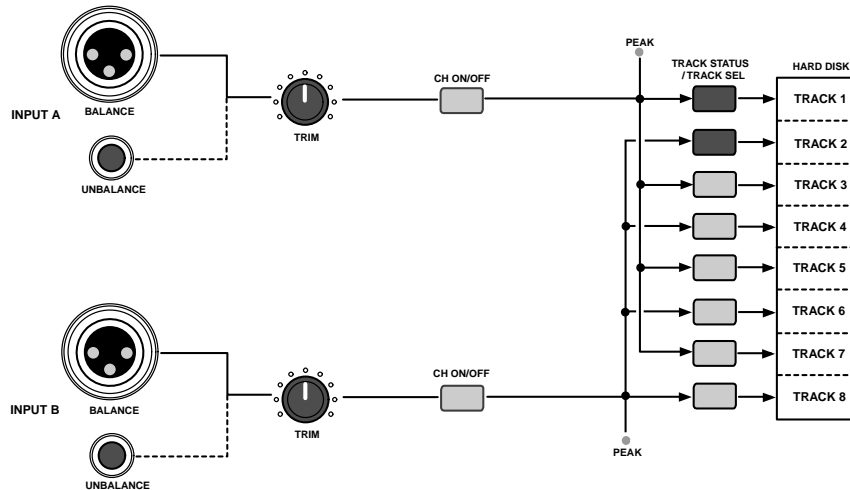

<Balanced (XLR) and unbalanced (phone) input connectors>

Both the balanced and unbalanced input connectors are provided for [INPUT A] and [INPUT B], allowing connection of balanced and unbalanced devices. In addition, the phantom (DC 48 V) power can be supplied to the balanced XLR inputs, so you can use condenser microphones that need the phantom power (see the following section about how to use condenser microphones).

<Note>: You cannot use both the balanced and unbalanced inputs simultaneously.

When plugging the unbalanced (phone) input connector, the balanced (XLR) input connector is disconnected.

• How to use condenser microphones

When connecting a condenser microphone that needs the phantom power, set the [PHANTOM] switch on the rear panel to "ON". Read the following notes carefully before using the phantom power.

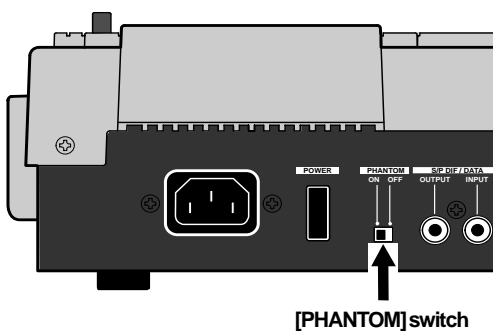

<Important notes for on/off switching>

Note that the VF80EX power must be ON when changing the [PHANTOM] switch setting. Also note that the [PHANTOM] switch should be set to "OFF" after using the phantom power.

<Notes for using the phantom power>

• Be sure to keep the following notes.

- * When connecting a condenser microphone to the balanced input connector of the VF80EX, check whether or not the microphone needs the phantom power (+48 V).
- * Switch the [PHANTOM] switch to ON after connecting a microphone.
- * When switching the [PHANTOM] switch, or when plugging or unplugging a microphone, mute the VF80EX output signals.
- * When connecting a dynamic microphone to the balanced input connector, set the [PHANTOM] switch to OFF. Otherwise, the microphone may damage.

• You cannot use the phantom power for following microphones.

- * microphones with the unbalanced output
- * high impedance microphones
- * microphones with the XLR connectors that leaks a signal between pin #2 and pin #1 or pin #3 and pin #1
- * microphones with the center tapout type ground such as old-fashioned ribbon microphones

Basic recording (recording onto a single track)

At first, let's record a single sound source onto a single track to know the basic recording procedure of the VF80EX. There are 8 recording tracks (Tracks 1 through 8) and you can record onto any desired track(s). In the following example, we are going to record an electric guitar (with an effect unit) onto Track 1. Before starting, set all the track faders (1 through 6 and 7-8) and the master fader to the lowest position ($-\infty$), and the [TRIM] knob to the left most position (LINE).

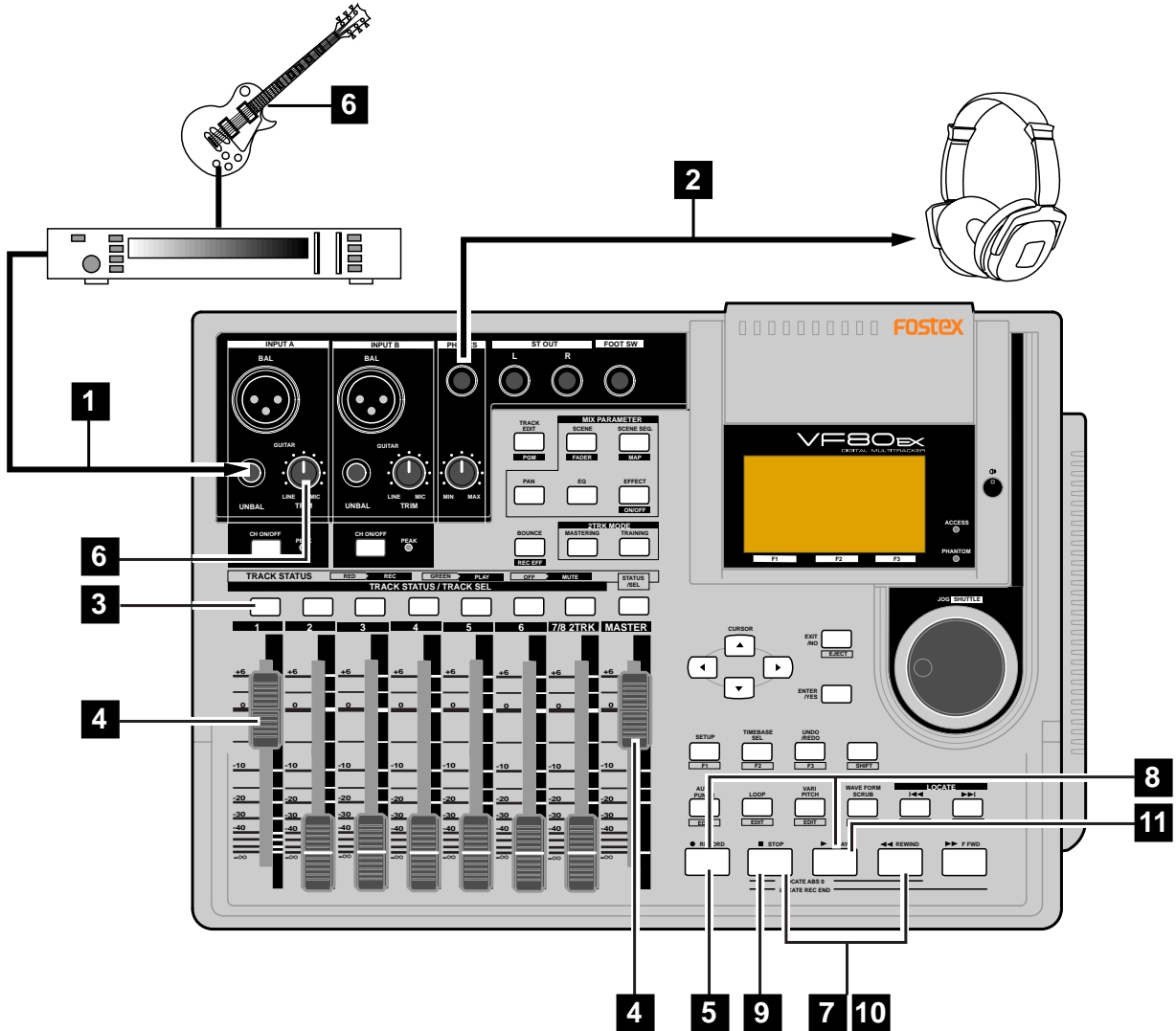

Preparation for recording

- 1** Connect the [INPUT A] UNBAL jack to the output of the effect unit whose input is connected to a guitar. To record onto Track 1, 3, 5 or 7, use INPUT A.
- 2** Connect the [PHONES] jack to headphones for monitoring.
- 3** Press the [TRACK STATUS/TRACK SEL] key of Track 1.
The key lighting in green changes to flashing in red, showing Track 1 is now armed. (The "Remain" time is shown on the screen.)
The [CH ON/OFF] key of INPUT A automatically lights. In this condition, by pressing the [CH ON/OFF] key of INPUT A, INPUT A can be muted.

- 4** Raise both the track 1 fader and master fader to "0" position.

This is preparation for monitoring sound. If both of these faders are set at the minimum position, no sound can be monitored.

<Note>: The track 1 fader can be used for adjusting the monitor level without affecting the recording level. To adjust the recording level, use the [TRIM] knob of INPUT A.

- 5** Press the [RECORD] key.
The key starts flashing in red, while Track 1 (which is armed) changes to the input monitor mode.

- 6** Use the [TRIM] knob of INPUT A while playing the guitar to get proper gain.

Set the gain at maximum within the range in which the [PEAK] indicator does not turn on when playing the guitar at the loudest volume. You can monitor both the input level of Track 1 and the stereo (L & R) output level from the bar-graph meters on the screen.

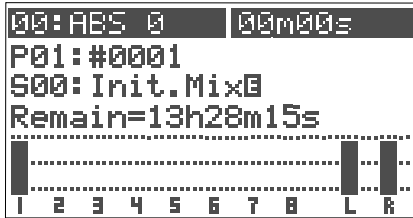

<Note>: Set the gain not to light the [PEAK] indicator when playing the guitar at the loudest volume. When the [PEAK] indicator lights, the input level is too high and the sound may be distorted or digital noise may be generated.

In the condition above, if you turn the [PHONES] knob clockwise, you can monitor the sound from the headphones.

<Warning!>: Be careful not to excessively raise the [PHONE] volume. Prolonged exposure to loud sounds may have an adverse effect on hearing.

Recording

- 7** Press the [REWIND] key while holding down the [STOP] key to locate to "ABS 0".

If the current recorder position is "ABS 0", you can skip the operation above.

- 8** Press the [PLAY] key while holding down the [RECORD] key to start recording.

The [TRACK STATUS/TRACK SEL] key of Track 1 and the [RECORD] key light on, showing the VF80EX is now recording.

The VF80EX uses the direct recording method. In this method, a digital signal just after the A/D conversion is directly recorded onto a track, without being routed to extra algorithms such as EQ.

You can add reverb or equalize the sound during mixdown.

In addition, the insert effect function allows rerecording a track sound with applying a distortion-type effect later. See "using the insert effect" on page 83.

When the recorder starts running, the mark number and name shown on the top line of the screen changes as below, showing that the current position is ahead of "ABS 0" point.



- 9** To stop recording, press the [STOP] key.

After showing "Please Wait!", the LCD returns to the Normal screen.

<Unarming a track>

To unarm a track, press the flashing [TRACK STATUS/TRACK SEL] key twice. The key changes to light in green.

Now you have recorded a sound source onto a track.

Playback

- 10** Press the [REWIND] key while holding down the [STOP] key to locate to "ABS 0".

- 11** Press the [PLAY] key to start playback.

You can control the playback level by the track 1 fader. If you find that the recording was not successfully made, use the undo/redo function and try recording again.

<Track muting >

The playback level of each recorded track can be controlled using the corresponding track fader.

You can mute the playback track by pressing the corresponding [TRACK STATUS/TRACK SEL] key except in the mix parameter edit mode.

Undo/Redo

After finishing a recording, pressing the [UNDO/REDO] key returns to the condition just before recording (Undo).

If you press the [UNDO/REDO] key again, you can cancel the Undo operation and return back to the condition after recording.

[UNDO/REDO] key

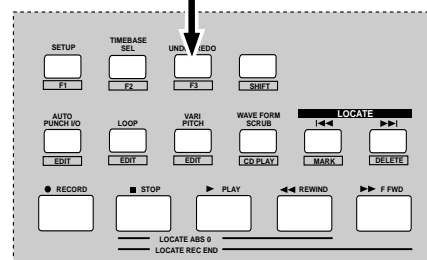

<Note>: The undo/redo function is available to any recording, however, if you carry out any of the following operations after recording, you cannot use the undo/redo function.

Therefore, if you are not satisfied with the recording, press the [UNDO/REDO] key immediately to undo the recording and make recording again.

- * Making a new recording
- * Making a new editing (copy, move, erase, auto punch in/out, etc.)
- * Turning off the power
- * Executing program select, rename, and deleting
- * Executing drive selection

Basic recording (recording onto two tracks)

After recording onto track 1 as described in the previous section, let's make recording of a stereo sound source onto tracks 3 and 4.

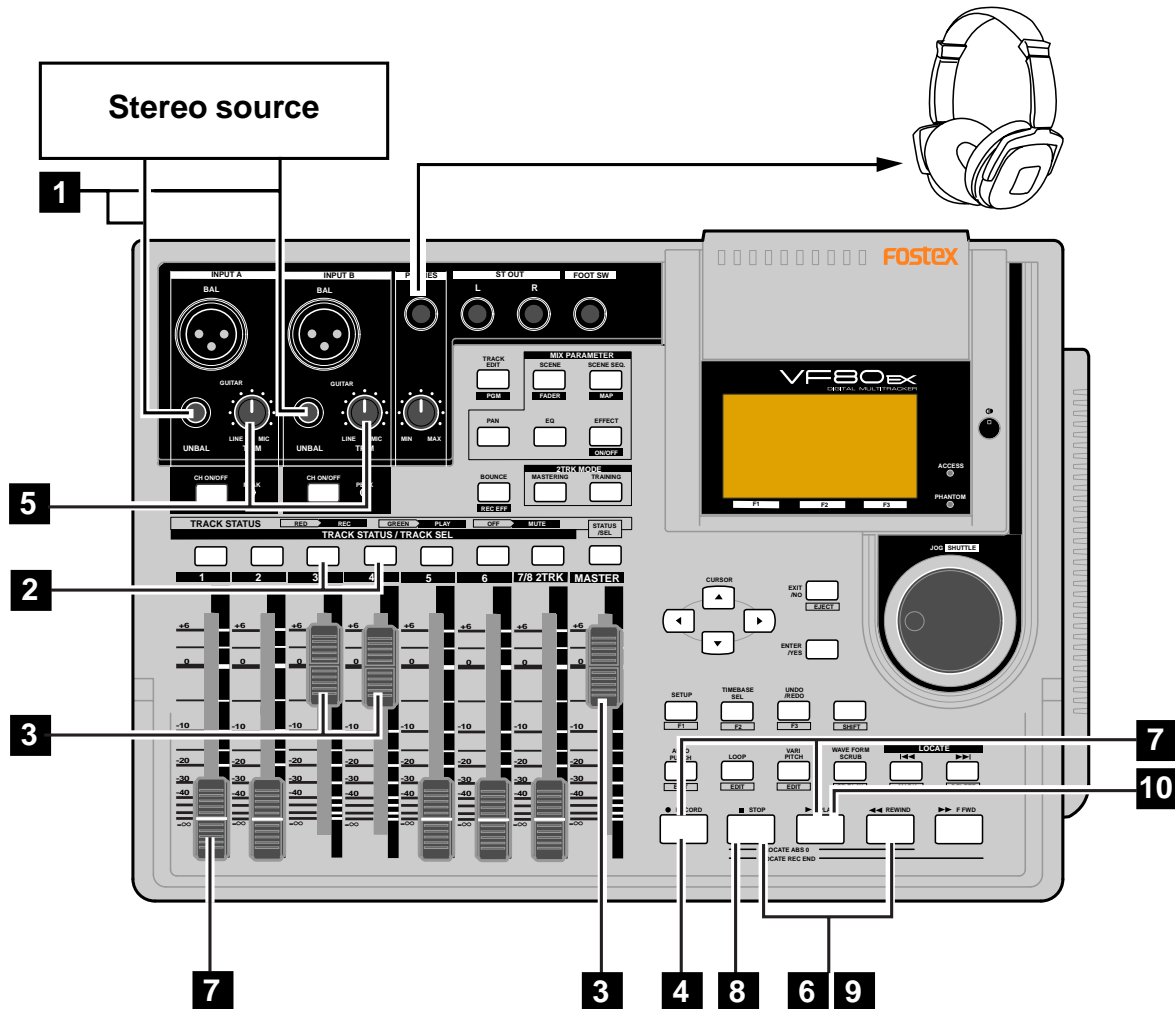

Preparation for recording

1 Connect the [INPUT A] UNBAL and [INPUT B] UNBAL jacks to the L and R outputs of the stereo source respectively.

2 Press the [TRACK STATUS/TRACK SEL] keys of Tracks 3 and 4.
The keys lighting in green change to flashing in red, showing Tracks 3 and 4 are now armed. (The "Remain" time is shown on the screen.)
The [CH ON/OFF] keys of INPUT A and B automatically light in green.

3 Raise the faders of tracks 3 and 4 and [MASTER] fader to "0" position.
This is preparation for monitoring sound. If both of these faders are set at the minimum position, no sound can be monitored.

4 Press the [RECORD] key.
The [RECORD] key starts flashing in red, while Tracks 3 and 4 (which are armed) changes to the input monitor mode.

5 Use the [TRIM] knobs of INPUT A and B while playing the stereo source to get proper gain.
Set the gain at maximum within the range in which the [PEAK] indicator does not turn on.
You can monitor both the input level of Tracks 3 and 4 from the bar-graph meters on the screen.

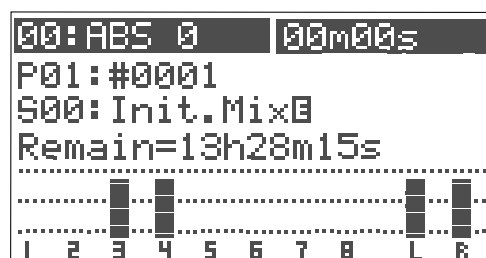

<Note>: Set the gain not to light the [PEAK] indicator. When the [PEAK] indicator lights, the input level is too high and the sound may be distorted or digital noise may be generated.

In the condition above, if you turn the [PHONES] knob clockwise, you can monitor the sound from the headphones.

<Warning!>: Be careful not to excessively raise the [PHONE] volume. Prolonged exposure to loud sounds may have an adverse effect on hearing.

Recording

6 Locate to the start position (time) for recording.

7 Press the [PLAY] key while holding down the [RECORD] key to start recording.

The [TRACK STATUS/TRACK SEL] keys of Tracks 3 and 4, as well as the [RECORD] key light on, showing the VF80 is now recording.

You can see the meter for Track 1 also moving. By raising the Track 1 fader, you can make overdubbing onto tracks 3 and 4 while listening to playback of track 1.

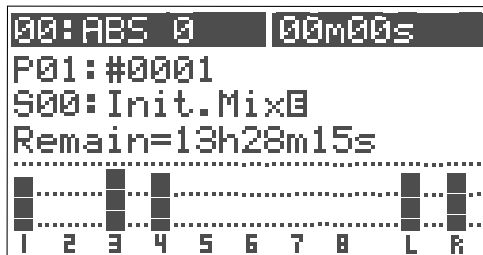

When the recorder starts running, the mark number and name shown on the top line of the screen changes as below, showing that the current position is ahead of "ABS 0" point.



8 To stop recording, press the [STOP] key.

After showing "Please Wait!", the LCD returns to the Normal screen.

<Unarming tracks>

To unarm tracks now recorded, press the flashing [TRACK STATUS/TRACK SEL] keys again. The keys changes to light in green.

Now you have recorded a stereo source onto two tracks (3 and 4).

Playback

9 Locate to the desired position (time) for playback.

10 Press the [PLAY] key to start playback.

You can control track playback levels by using the corresponding track faders.

If you find that the recording was not successfully made, use the undo/redo function and try recording again.

<Track muting>

The playback level of each recorded track can be controlled using the corresponding track fader. You can mute the playback tracks by pressing the corresponding [TRACK STATUS/TRACK SEL] keys except in the mix parameter edit mode.

<How to use recording tracks effectively>

The VF80EX has 8 recordable tracks. If you record materials onto all 8 tracks according to the procedures described in "Basic recording", you cannot record further materials. To record more materials, you can use the "track bounce" technique to save tracks as follows:

1. Record materials onto tracks 1 through 6.
2. Mix the signals recorded on tracks 1 through 6 and record the mixed signal onto tracks 7 and 8.

Then tracks 1 through 6 can be used to record other materials.

This is the basic technique used for Multitrackers. We recommend that tracks 7 and 8 are basically used as the destination tracks of "track bounce" from tracks 1 through 6.

See "Advanced Operation" for details about the track bounce technique.

In addition, tracks 7 and 8 play an important role in "training mode" and "mastering mode" described later in "Advanced functions".

The VF80EX also provides the "track exchange" function which allows you to keep recordable tracks.

The VF80EX has 16 additional tracks for each program, in addition to 8 recordable (and playable) real tracks (1 through 8). The "track exchange" function allows you to exchange a real track and an additional track, making the real track empty.

See page 56 "Recorder functions."

Mark function

The VF80EX has the Mark function which allows you to set marks at the desired positions in a song. You can locate to a mark position immediately, as well as use mark positions for the punch in and out points, beginning and end points for repeat and editing points for track editing such as copy, move, erase, etc. This section describes how to set, delete and locate to a mark. For details about editing a mark, see “Recorder functions” described later.

Setting a mark on the fly

In the initial condition, Mark 00 is automatically entered at the beginning of the current program (ABS 0) and named “ABS 0”.

You can enter up to 99 marks (Mark 01 through 99). Mark number and name are shown on the Normal screen as the arrow points in the screen example below. (You cannot edit or delete Mark 00.)



- 1 During playback (or while stopped), press [◀◀/MARK] key while holding down the [SHIFT] key.

“Entry Mark” is shown briefly and a mark is entered at the current position.

Also the time marked is entered in the mark map list (see “Recorder functions” for details).

- 2 To enter another mark, repeat step 1) above.

<Note>

Marks are assigned in ascending order of ABS time. For example, even if you enter marks in order as shown in the upper diagram below, the mark numbers are assigned as shown in the lower diagram.

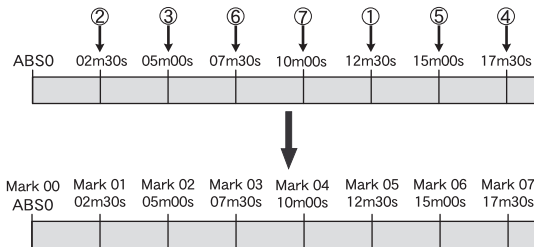

Locating a mark

You can locate to a mark using the [◀◀] or [▶▶] key.

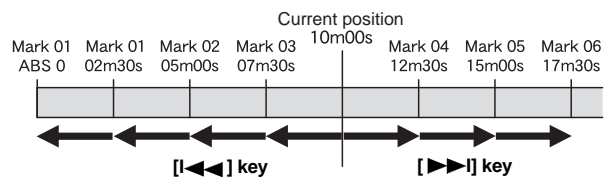

- Pressing [◀◀] key locates to the previous mark. In the example above, each time you press the key from the current position, the recorder will locate to Mark 03 -> 02 -> 01 -> 00.
- Pressing [▶▶] key locates to the next mark. In the example above, each time you press the key from the current position, the recorder will locate to Mark 04 -> 05 -> 06.

The current (located) mark number is shown on the Normal screen.



Deleting a mark

You can delete unnecessary mark

- 1 While stopped, locate to the mark to be deleted using the [◀◀] or [▶▶] key. The mark to be deleted is shown on the screen.
- 2 Press the [▶▶/DELETE] key while holding down the [SHIFT] key. A pop-up panel asking for confirmation to delete the current mark appears, in which “Sure?” blinks. To cancel the operation for deletion, press the [EXIT/NO] key.
- 3 Press the [ENTER/YES] key while holding down the [RECORD] key. The current mark is deleted.

ABS locate functions

There are four types of the **ABS locate** functions as below.

- Pressing the **[REWIND]** key while holding down the **[STOP]** key locates to the beginning of the current program (ABS 00), regardless of the time base setting.
- Pressing the **[F FWD]** key while holding down the **[STOP]** key locates to the end position of the last recording of the current program (REC END).
You can use this function to locate to the end point of a song or to check the length of a song.
- Pressing the **[PLAY]** key while holding down the **[STOP]** key locates to the beginning of the last playback.
- Pressing the **[RECORD]** key while holding down the **[STOP]** key locates to the beginning of the last recording.

Punch in/out

If you are not satisfied with your recording and want to modify only a specific part, you can replace the part with a new recording using the punch in/out technique.

“Punch in” switches the transport mode from playback to recording, while “Punch out” switches the transport mode from recording to playback. The point at which a punch in is carried out is called a “punch in point”, while the point at which a punch out is carried out is called a “punch out point.”

You can carry out the punch in/out operation in 3 ways:

- * **Manual punch in/out using the keys on the unit**
- * **Using the foot switch (Model 8051)**
- * **Auto punch in/out function**
After setting the punch in and out points, the punch in/out can be took place automatically.

The following description is assumed that the track(s) to be punched in/out are armed and the source input level is set appropriately by using the **[TRIM]** knob.

Manual punch in/out using the keys on the unit

- 1 Start playback by pressing the [PLAY] key from a position before the punch in point.**
- 2 When the playback position reaches the punch in point, press the [RECORD] key while holding down the [PLAY] key.**
Only the armed track(s) switch from playback to recording.
- 3 At the punch out point, press the [PLAY] key .**
The armed track(s) switch from recording to playback.

Punch in/out using the foot switch

- 1 Connect the Model 8051 foot switch to the [FOOT SW] jack.**

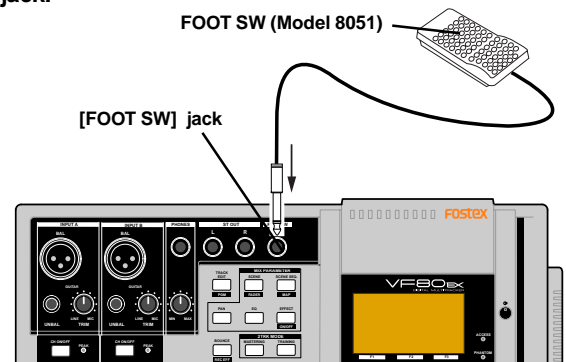

<Note>

Do not power on the machine with non-specified foot SW connected to the foot SW jack.
When powering on the machine with non-specified foot SW (latch type foot SW, etc.) connected to the foot SW jack, there is a case that the machine does not correctly boot up with “No Drive!” alert message. In such a case, power off the machine once, disconnect the foot SW and then power back on.

- 2 Start playback by pressing the [PLAY] key from a position before the punch in point.**
- 3 When the playback position reaches the punch in point, step on the foot switch.**
Only the armed track(s) switch from playback to recording.
- 4 At the punch out point, step on the foot switch.**
The armed track(s) switch from recording to playback.

Auto punch in/out function

You must set the punch in and out points before performing auto punch in/out recording. You can set the points either during playback and while stopped. In the following description, we assume that the "ABS" time base is selected.

• Setting the punch in/out points on the fly during playback (or while stopped)

- 1 Press the [AUTO PUNCH/EDIT] key while holding down the [SHIFT] key. The screen for setting the punch in/out points appears.

During playback, this counter shows the current recorder position in real time.



- 2 At the point at which you want to set the punch in point, press the [SETUP/F1] key while holding down the [SHIFT] key.

"In Point Stored!" appears briefly, and the point is stored as the punch in point.

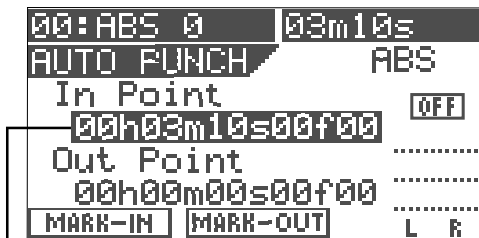

The time (or bar/beat) stored is shown here.

- 3 At the point at which you want to set the punch out point, press the [TIME BASE SEL/F2] key while holding down the [SHIFT] key.

"Out Point Stored!" appears briefly, and the point at which you carry out the operation above is stored as the punch out point.

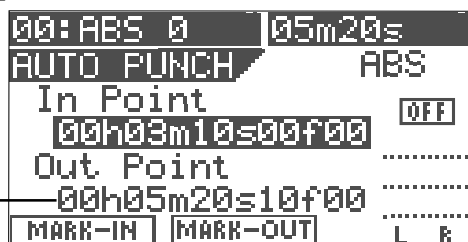

The time (or bar/beat) stored is shown here.

<Note>

Set the punch in point earlier than the punch out point.

• Setting the punch in/out points numerically

While the recorder is stopped, you can set the in and out points by entering the time numerically.

- 1 While stopped, press the [AUTO PUNCH/EDIT] key while holding down the [SHIFT] key.

The screen for setting the punch in/out points appears.



- 2 Press the [ENTER/YES] key while the punch in point value is highlighted on the screen as above.

Now you can edit the punch in point value.

Initially, the "seconds" value starts blinking, showing that it can be edited.

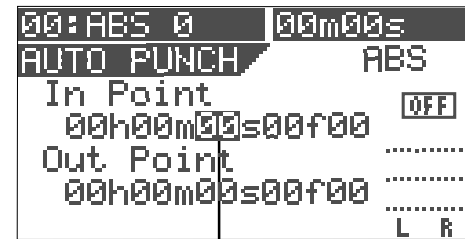

Flashing

- 3 Move the blinking value by using the [CURSOR </>] key and enter the desired value using the [JOG] dial.

- 4 After completing editing the time value, press the [ENTER/YES] key.

The edited time is stored as the punch in point.

- 5 Use the [CURSOR </>] key to highlight the punch out point value, and press the [ENTER/YES] key.

Now you can edit the punch out point value.

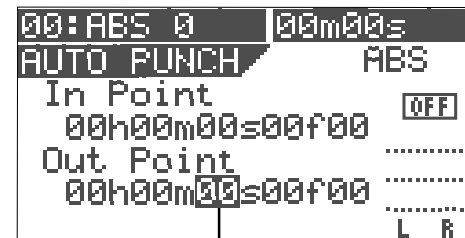

Flashing

- 6 Enter the desired value with the same method as entering the punch in point, then press the [ENTER/YES] key.

The edited time is stored as the punch out point.

- 7 After storing times for both points, press the [EXIT/NO] key.

The LCD returns to the Normal screen.

- **Taking a mark point in the punch in or punch out point**
You can take a mark point in the punch in or out point.

<Note>
The following operation is possible only when any marks are stored using the Mark function described earlier.

- 1 Press the [AUTO PUNCH/EDIT] key while holding down the [SHIFT] key.
The screen for setting the punch in/out points appears.

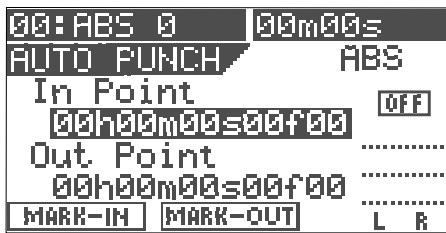

- 2 Press the [TIME BASE SEL] key when the in point time value is highlighted (as above).
The highlighted line changes to show a mark.

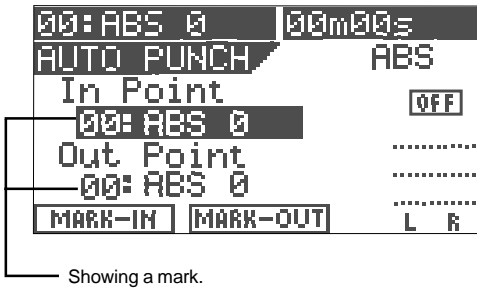

- 3 Press the [ENTER/YES] key.
The highlighted mark starts blinking.

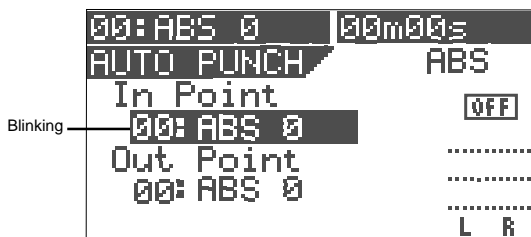

- 4 Use the [JOG] dial to select the desired mark, and then press the [ENTER/YES] key.
The selected mark position is taken in the punch in point.
- 5 Use the [CURSOR ▼] key to highlight the punch out point value, and press the [ENTER/YES] key.
- 6 Use the [JOG] dial to select the desired mark, and then press the [ENTER/YES] key.
The selected mark position is taken in the punch out point.
- 7 After setting both points, press the [EXIT/NO] key.

- **Performing auto punch in/out recording**
After storing the punch in and out points, you can perform the auto punch in/out recording.

- 1 Press the [AUTO PUNCH /EDIT] key (to illuminate the key).
The auto punch mode is now active.
- 2 Locate to the earlier position to the punch in point.
- 3 Press the [RECORD] key while holding down the [PLAY] key.
A "take" of auto punch in/out recording starts and "TAKE" lights up on the screen.

The recorder starts playback, and then automatically puts into the record mode at the punch in point. It automatically switches to playback at the punch out point.

<Rehearsal>
In the step 3) above, if you press only the [PLAY] key, a "rehearsal" of auto punch in/out recording starts and "RHSL" lights up on the screen. In the rehearsal mode, when the recorder reaches the punch in point, only the monitor of the armed track(s) switches to "Input monitor" without performing actual recording. You can rehearse as many times as you like before actual recording.

Hint:
If you use the loop function together with the rehearsal mode, you can rehearse your playing repeatedly without the need of the recorder operation, allowing you to concentrate on your playing. See "Recorder functions" for details about the loop function.

Mixing

After recording all tracks (1 through 8), you can tailor the sound of each track. The following describes about settings for level, pan, EQ and effects.

Adjusting levels

- 1 Adjust the playback level of each track using the corresponding fader (1 through 6 and 7/8).

The levels of tracks 7 and 8 are simultaneously controlled by a single fader (7/8).

- 2 Adjust the stereo master output (ST OUT L/R) levels using the [MASTER] fader.

<About master output levels>
 You can view the stereo master output (L/R) levels from the L/R level meters on the screen. The output levels are affected by the [MASTER] fader position. Be sure not to set the fader level too high to avoid the sound distorted.

Setting pan position

You can set the pan position of each track.

- 1 Press the [PAN] key. The pan setting screen is shown, where "Select TRK!" is flashing in the initial condition.

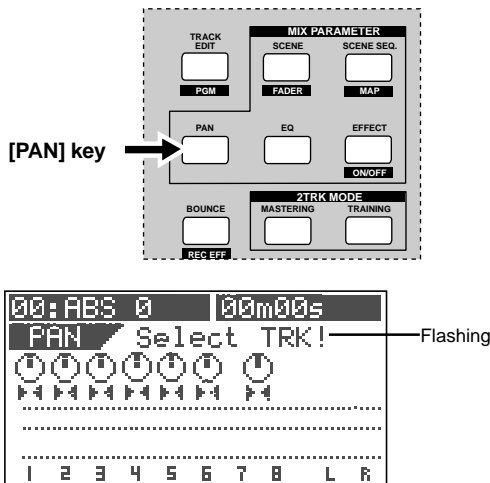

- 2 Press the [TRACK STATUS/TRACK SEL] key of the desired track (or use the [CURSOR </>] keys to select the desired track).

The pan icon of the selected track is highlighted, showing that it is editable.



- 3 Set the pan position using the [JOG] dial. The pan icon on the screen changes in real time according to the rotation of the [JOG] dial.

- 4 Repeat steps 2) and 3) to set other tracks.

- 5 After completing the pan setting, press the [EXIT/NO] key. The LCD returns to the Normal screen.

Adjusting EQ

- 1 Press the [EQ] key. The EQ screen is shown, where "Select TRK!" is flashing in the initial condition.

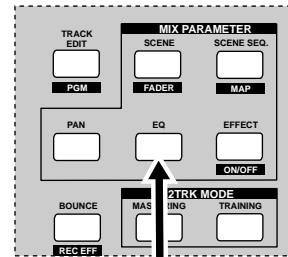

[EQ] key

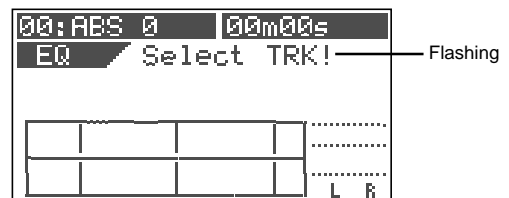

- 2 Press the [TRACK STATUS/TRACK SEL] key of the desired track.

The default preset library entry ("L00: 2-SHLV") is shown, in which the High Gain field is highlighted, showing that it can be edited.

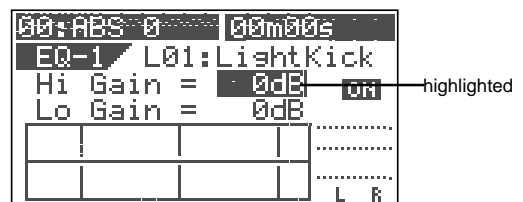

<Selecting from the EQ library>:
 There are 36 presets besides the default preset in the EQ library. You can select a desired preset according to the situation and tailor the sound. See "Mixer functions" for details.

- 3 Edit the "Hi Gain" value using the [JOG] dial. The EQ curve is shown according to the value setting, while the sound changes in real time. You can set the value between -18 dB and + 18 dB.

- 4** Highlight the “Lo Gain” field by using the [CURSOR ▼] key, and edit the “Lo Gain” value using the [JOG] dial. You can set the value between -18 dB and + 18 dB, as same as the Hi Gain.
- 5** Repeat steps 2 through 4 to edit EQ on other tracks.
- 6** After completing the EQ setting, press the [EXIT/NO] key. The LCD returns to the Normal screen.

Setting effects

There are two methods for using the internal effect processor of the VF80EX: “loop effect” and “insert effect”. The following describes how to set the send level and select an effect type of the loop effect. See “Mixer Function” for details about the loop effect, such as how to make pre/post setting of an effect send or how to set effect parameters. See also “Advanced Operations” on page 83 for details about the insert effect.

- 1** Press the [EFFECT] key. The effect send level setting screen appears initially. Each press of the [EFFECT] key switches between the effect send level setting screen, effect type selection screen and effect send pre/post selection screen.

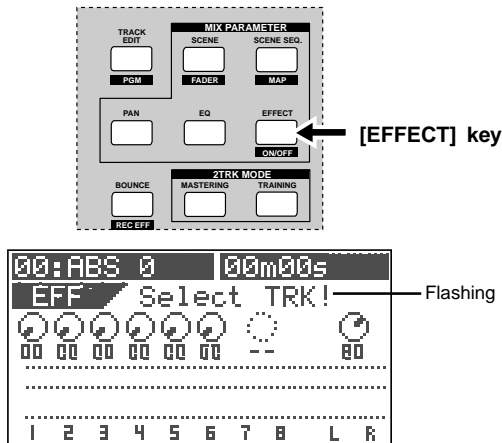

Effect send level setting

- 2** While the effect send level setting screen is shown, press the [TRACK STATUS/TRACK SEL] key of the desired track. The effect knob icon of the selected track is highlighted, showing that it can be edited. The default value for track sends 1 through 6 is “0” while the default value for the master is “80”.

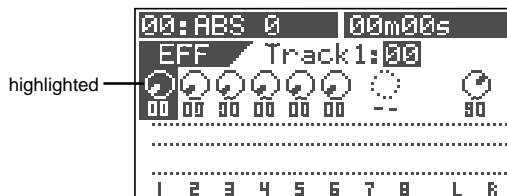

- 3** Use the [JOG] dial to enter the send level. While the send level changes, the corresponding icon also changes in real time. When the value increases, the effect sound of the currently selected effect type will be output.
- 4** To set the effect send levels for other tracks, carry out step 2 and 3 above repeatedly.

Effect type setting

The VF80EX provides 38 effect types (L01 through L38) used for the loop effect and 6 effect types (L39 through L44) used for the insert effect.

- 2** Bring up the effect type setting screen and select the desired effect type by rotating the [JOG] dial. While rotating the [JOG] dial, the effect type appears one after the other among 38 types (L01 ~ L38).

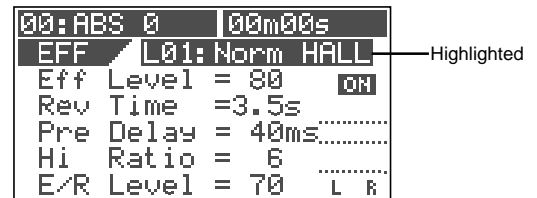

<Note>

If you select an effect type used for the insert effect (i.e. any one of L39 through L44), the screens for effect type selection and effect send pre/post selection are not shown.

- 3** After selecting the desired effect type, press the [ENTER/YES] key. The selected effect type is set.
- 4** Press the [EFFECT] key to bring up the effect send level setting screen.
- 5** Adjust the effect send levels as described above.

<Pre/post setting of effect sends>

All the effect sends from tracks 1 through 6 are initially set to “post-fader”. Therefore, when a track fader is completely down, no signal is sent even if you raise the effect send level of the track. You can also select “pre-fader” if necessary. See “Mixer functions” for details.

<Parameter setting for each effect type>

You can set parameters for the selected effect type. See “Mixer functions” for details about parameter setting.

<On/Off setting of the effect>

You can switch on or off the effect alternately by pressing the [EFFECT/ON/OFF] key while holding down the [SHIFT] key. See “Mixer functions” for details.

Mixdown

After tailoring sound of all the tracks, let's make a master tape (disc) using your master recorder (cassette, DAT, MD, etc.). As the VF80EX can feed the stereo outputs (L and R) via the S/PDIF (coaxial) digital output jack, you can make the master tape (disc) in digital domain if your recorder provides a digital input jack. If your digital recorder only provides the optical input jack, use the Fostex COP-1 optical to coaxial converter.

<Using the mastering mode/internal mastering mode:>

The VF80EX provides the "mastering mode" and "internal mastering mode".

In the **mastering mode**, you can record a material mixed down to track 7 and 8 to an external master recorder, while applying sound processing. The mastering mode allows you to perform advanced mastering. See "Advanced Operations" on page 76 for details about the mastering mode.

In the **internal mastering mode**, you can create a master song inside the VF80EX, without the need of using an external master recorder. Also, you can create an audio CD from master materials mastered in the mastering mode. (Note that you need the optional CD-RW drive to create an audio CD.)

See "Advanced Operations" on page 79 for details about the internal mastering mode, and "Save/load of song data" on page 125 for details about creating an audio CD.

Digital mixdown

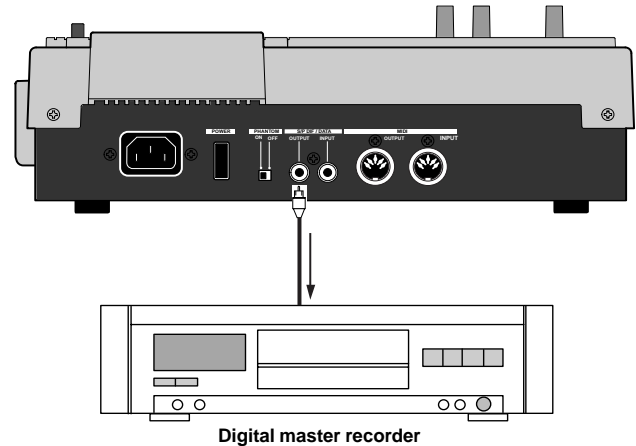

Analog mixdown

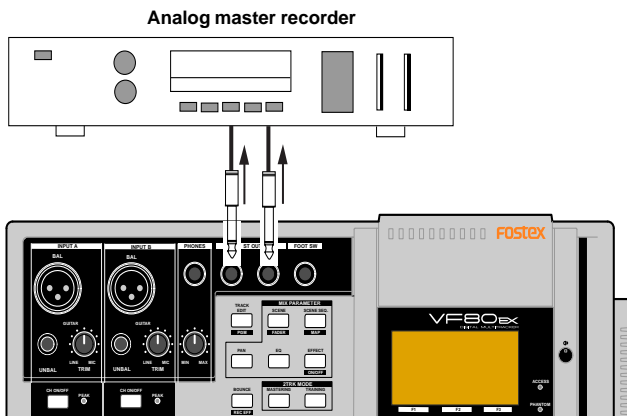

1 Connect the [ST OUT - L/R] jacks to the input jacks of your analog master recorder.

2 Set the recording level of the master recorder.

3 Start recording the master recorder, and start playback of the VF80EX from the beginning of the song.

4 When recording finishes, stop both the units.

<Fade in/out:>

You can fade in or fade out a song by using the [MASTER] fader.

1 Connect the [DATA OUTPUT] jack to the digital input jack of your master recorder.

2 Set the master recorder's recording source to the digital input.

- The sampling frequency of the VF80EX is fixed to 44.1 kHz, so you cannot record the VF80EX digital output signal to the master recorder that cannot accept 44.1 kHz digital signals.
- In general, you cannot adjust the digital input level of a digital recorder.

3 Adjust the stereo output level of the VF80EX using the [MASTER] fader.

- In general, set the fader so that the level meter on the master recorder indicates "0" when the VF80EX feeds the loudest level signal. If the level is too high, the sound may be distorted.

4 Start recording the master recorder, and start playback of the VF80EX from the beginning of the song.

5 When recording finishes, stop both the units.

Mixer Functions

Initial condition when turning on the power

When turning on the power, the VF80EX starts up while showing the unit information on the LCD display and then gets ready when the screen below appears. This screen is called "**Normal Screen**", in which the program number and current recorder position are shown. In the following example (the default), Program 1 (P01) is loaded and the current position is the beginning (ABS 00M 00S).

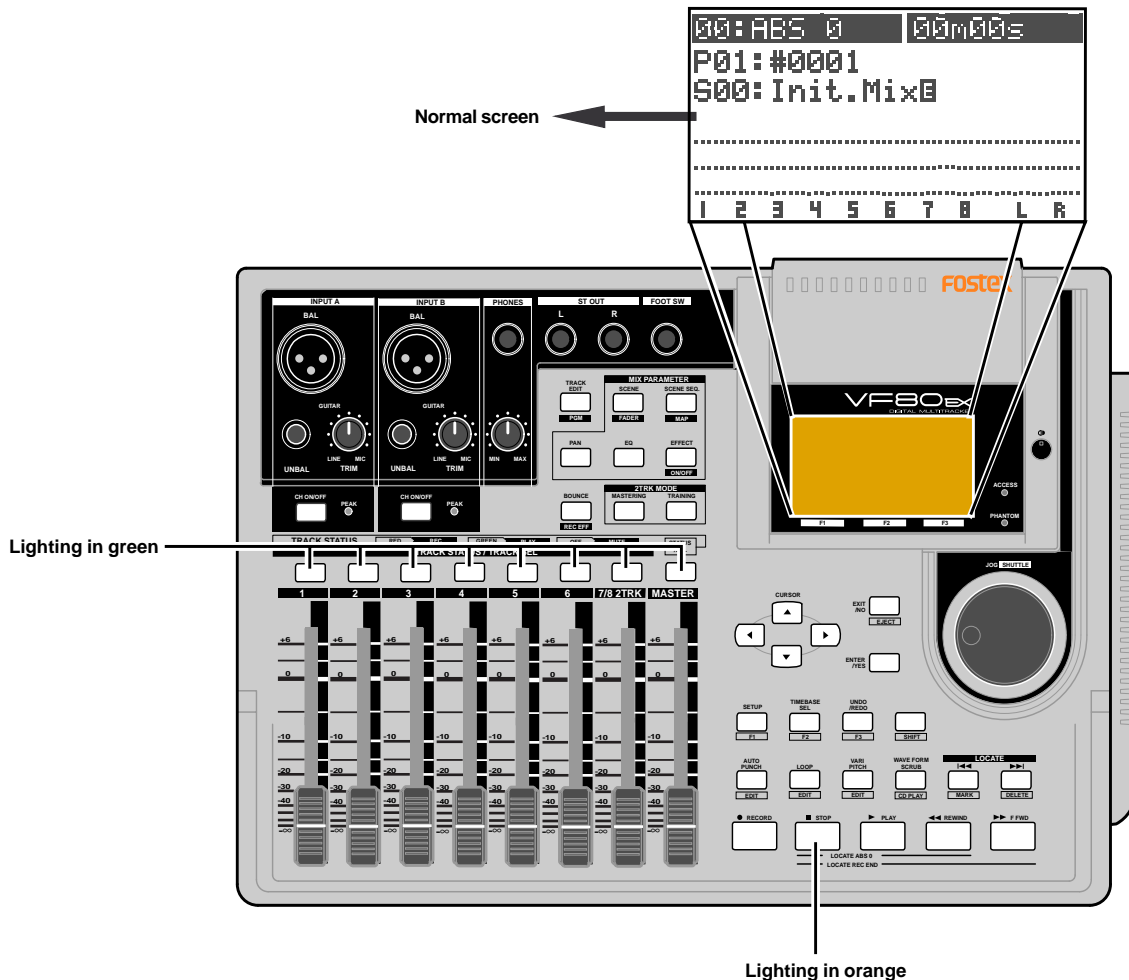

Operations while the Normal screen is shown

Fader

The fader for each track (1 through 6 and 7/8) controls the level of the playback signal fed to the stereo outputs.

Track mute

While the VF80EX is not in the mix parameter edit mode, pressing any one of the **[TRACK STATUS/TRACK SEL]** keys (for tracks 1 through 6 and 7/8) mutes the corresponding track.

The **[TRACK STATUS/TRACK SEL]** key for the muted track is unlit. Pressing the key again releases muting and lights up the key.

Master fader mute

While the VF80EX is not in the mix parameter edit mode, pressing the **[STATUS/SEL]** key for the master fader mutes the stereo outputs.

While the stereo outputs are muted, the **[STATUS/SEL]** key is unlit. Pressing the key again releases muting and lights up the key.

Mix parameter section

The Mix parameter section provides five keys that are used for mixer function settings. By pressing one of these keys alone or while holding down the **[SHIFT]** key, you can execute the following.

<Note>: The VF80EX mixer channels always receive corresponding track signals. They do not receive input signals.

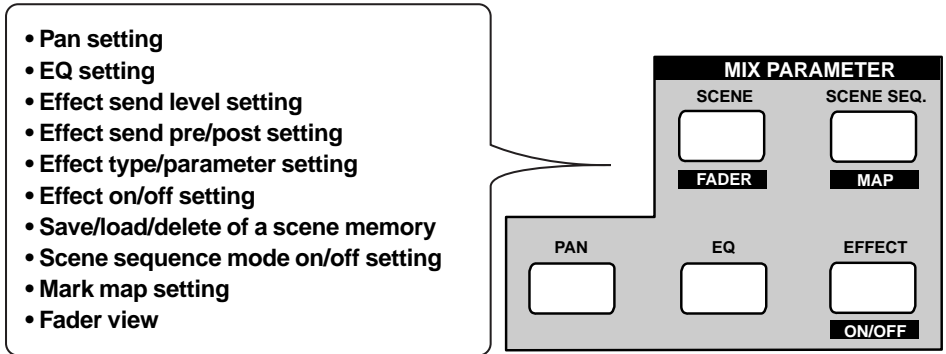

Adjusting pan positions

You can adjust the pan position of each track signal fed to the stereo outputs.

1 Press the **[PAN]** key.

The pan screen appears.

If you have not edited any track parameter for pan, EQ or effect send setting after turning on the power last time, the message prompting to select a track ("Select TRK!") flashes, as well as all the **[TRACK STATUS/TRACK SEL]** keys on the panel flash.

If you have edited any track parameter for pan, EQ or effect send setting after turning on the power last time, the icon for the previously edited track is highlighted, showing that it can be edited.

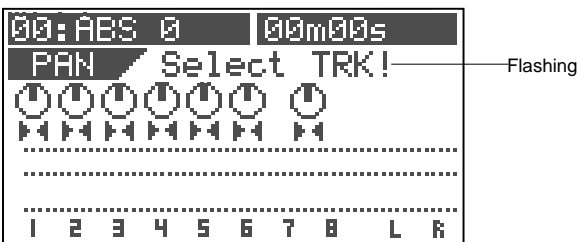

2 Select the desired track by pressing the corresponding **[TRACK STATUS/TRACK SEL]** key (or using the **[CURSOR </>]** keys).

The pan icon of the selected track is highlighted, indicating that you can edit it.

The **[TRACK STATUS/TRACK SEL]** key of the selected track flashes.

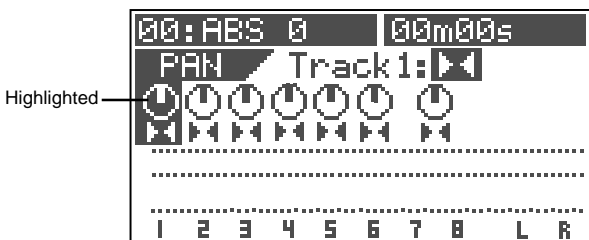

3 Use the **[JOG]** dial to adjust the pan position.

The pan position is set according to the rotating degree. The following show examples of the pan settings.

Pan position: center	Pan position: hard left	Pan position: hard right
<p>•Controllable tracks Tracks 1 through 6 and 7/8</p> <p>•Available values L10 (hard left) through C (center) to R10 (hard right) (the default setting: "C" for all tracks)</p>		

4 To adjust the pan position for another track, repeat steps 2 and 3 above.

5 After completing pan setting, press the **[EXIT/NO]** key.

The VF80EX exits the mix parameter edit mode and the LCD display returns to the Normal screen.

Editing EQ

The VF80EX is equipped with 2-band (HI and LO) EQ for Tracks 1 through 6. 36 preset entries are available in the EQ library.

<Note>: You can apply EQ only to Tracks 1 through 6. You cannot apply EQ to Tracks 7/8.

1 Press the [EQ] key.

The EQ screen appears.

If you have not edited any track parameter for EQ, pan or effect send setting after turning on the power last time, the message prompting to select a track ("Select TRK!") flashes, as well as the [TRACK STATUS/TRACK SEL] keys for Tracks 1 through 6 on the panel flash. If you have edited any track parameter for pan, EQ or effect send setting after turning on the power last time, the icon for the previously edited track is highlighted, showing that it can be edited.

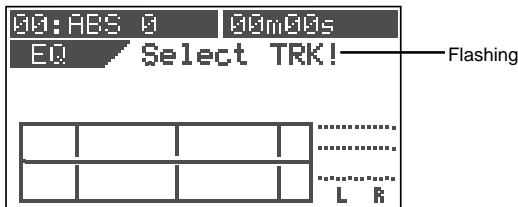

2 Select the desired track by pressing the corresponding [TRACK STATUS/TRACK SEL] key (or using the [CURSOR </>] keys).

The selected track number and library entry name (shown as "EQ-1" and "L00:2-SHLV" respectively in the screen example below) are shown, together with the current settings. The gain value of Hi EQ ("Hi Gain") flashes, indicating that you can edit it.

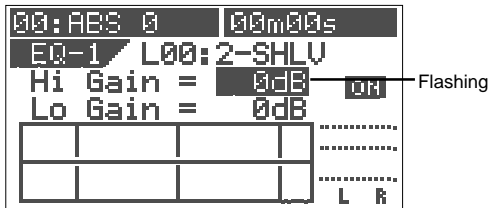

3 Use the [CURSOR ▲ / ▼] key to select a parameter to be edited.

Each time you press the [CURSOR ▼] key, the flashing parameter (to be edited) changes in the following order. Hi Gain -> Lo Gain -> EQ ON/OFF -> library entry -> Hi Gain...

Pressing the [CURSOR ▲] key changes the flashing parameter in the reverse order.

4 Use the [JOG] dial to edit the parameter value.

The following values are available for each parameter.

Hi Gain	-18 dB through 0 dB to +18 dB in 1 dB steps. The current EQ curve is shown graphically according to the current values.
Lo Gain	-18 dB through 0 dB to +18 dB in 1 dB steps. The current EQ curve is shown graphically according to the current values.
ON/OFF	ON or OFF of EQ

Library

Selectable from 36 preset library entries (L00 through L36). The default is "L00: 2-SHLV". After selecting the desired library, press the [ENTER/YES] key to confirm the setting.

*See the following table for details about the EQ library.

Setting example 1: Set "Hi Gain" to "+11 dB."

The high frequency gain is boosted up as shown graphically.

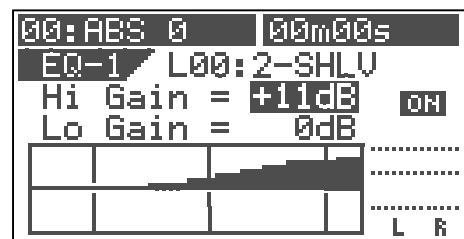

Setting example 2: Set "Lo Gain" to "-8 dB."

The low frequency gain is cut as shown graphically.

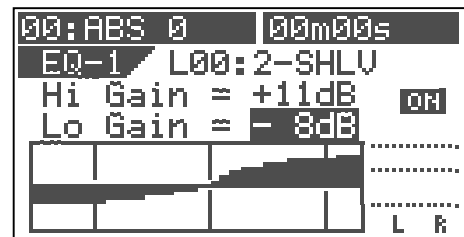

Setting example 3: Set "EQ library" to "L03."

The high frequency gain is boosted up as shown graphically.

By using the [JOG] dial to select "L03": Ana.Kick and pressing the [ENTER/YES] key, the preset parameter values are shown together with the corresponding EQ curve.

You can edit parameters from this preset condition and store the setting as a scene. Note that if you turn off the power, the setting is cleared.

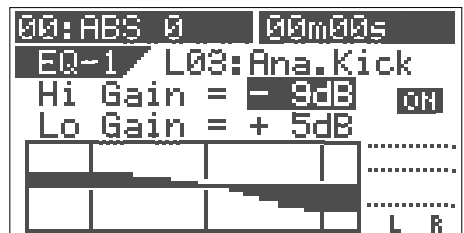

5 To edit the EQ for another track, repeat steps 2 through 4.

6 After completing EQ editing, press the [EXIT/NO] key. The VF80EX exits the EQ edit mode and the LCD display returns to the Normal screen.

Preset entries in the EQ library

L00: 2-SHLV		LO	HI
Flat setting The first time you bring up the EQ screen, this entry is selected.	Gain	0	0
	Freq.	400Hz	4kHz
	Q	L-S	H-S
L01: LightKick		LO	HI
Creates a light and jaunty kick sound	Gain	+6.0	-12.0
	Freq.	400Hz	600Hz
	Q	L-S	5.0
L02: TightKick		LO	HI
Creates a tight and hard kick sound.	Gain	+7.0	+10.0
	Freq.	400Hz	4kHz
	Q	L-S	8.0
L03: Ana.Kick		LO	HI
Makes an analog kick sound boomy.	Gain	+5.0	-9.0
	Freq.	550Hz	6kHz
	Q	L-S	H-S
L04: Snappy_SD		LO	HI
Makes a snare sound snappier.	Gain	-7.0	+6.0
	Freq.	1kHz	3.5kHz
	Q	L-S	2.5
L05: Power_SD		LO	HI
Creates a powerful and heavy snare sound.	Gain	+8.0	+5.0
	Freq.	150Hz	3.5kHz
	Q	4.5	2.5
L06: Deep_SD		LO	HI
Creates a heavy sound of a snare drum with a deep body.	Gain	+3.0	+4.0
	Freq.	550Hz	4.3kHz
	Q	4.5	2.2
L07: Talk_Tom		LO	HI
Creates a skinny tom-tom sound.	Gain	+4.0	+7.0
	Freq.	100Hz	3.2kHz
	Q	7.1	6.3
L08: Melo.Tom		LO	HI
Creates a melodious sound.	Gain	+6.0	-12.0
	Freq.	100Hz	1.7kHz
	Q	2.8	2.2
L09: W.GongTom		LO	HI
Makes a tom-tom sound woody.	Gain	-10.0	+17.0
	Freq.	130Hz	520Hz
	Q	L-S	7.1

L10: Lo-Fi_Cym		LO	HI
Removes the brightness from a cymbal sound by cutting high frequencies.	Gain	+3.0	-18.0
	Freq.	300Hz	8kHz
	Q	1.6	H-S
L11: Perc.		LO	HI
Creates a bright sound by emphasizing the attack of a conga, bongo, etc.	Gain	-4.0	+7.0
	Freq.	100Hz	6kHz
	Q	L-S	H-S
L12: Tamb.		LO	HI
Creates a subtle sound by emphasizing the presence of a tambourine, etc.	Gain	-8.0	+10.0
	Freq.	360Hz	5.4kHz
	Q	L-S	H-S
L13: Fat_Bass		LO	HI
Creates a fat base sound by slightly boosting the low frequency range.	Gain	+5.0	+3.0
	Freq.	100Hz	2.4kHz
	Q	0.1	6.3
L14: Norm.Bass		LO	HI
Creates a all-round bass sound.	Gain	+5.0	+4.0
	Freq.	190Hz	2.4kHz
	Q	1.0	1.0
L15: Loud_Bass		LO	HI
Creates a good analog bass sound by boosting the low frequency range and emphasizing the attack.	Gain	+4.0	+3.0
	Freq.	120Hz	1.3kHz
	Q	2.0	2.2
L16: Bright_Pf		LO	HI
Creates a bright piano sound.	Gain	-3.0	+4.0
	Freq.	340Hz	5kHz
	Q	0.9	H-S
L17: Loud_Pf		LO	HI
Creates a rich piano sound by boosting the low frequency range which contains rich harmonics.	Gain	+5.0	-3.0
	Freq.	200Hz	1.3kHz
	Q	L-S	0.9
L18: Power_Pf		LO	HI
Creates a tight and smooth sound. Suitable for a piano solo.	Gain	-13.0	+7.0
	Freq.	170Hz	5.4kHz
	Q	0.7	1.1
L19: E.Pf		LO	HI
Creates a sound which emphasizes the attack and distortion when hitting keyboards of an electric piano.	Gain	+8.0	+3.0
	Freq.	1kHz	6.4kHz
	Q	0.7	1.7

<p>L20: Clean_EG</p> <p>Adds a bright character to a transparent and clean electric guitar sound.</p>	<table border="1"> <thead> <tr> <th></th> <th>LO</th> <th>HI</th> </tr> </thead> <tbody> <tr> <td>Gain</td> <td>-4.0</td> <td>+4.0</td> </tr> <tr> <td>Freq.</td> <td>100Hz</td> <td>6.6kHz</td> </tr> <tr> <td>Q</td> <td>L-S</td> <td>H-S</td> </tr> </tbody> </table>		LO	HI	Gain	-4.0	+4.0	Freq.	100Hz	6.6kHz	Q	L-S	H-S
	LO	HI											
Gain	-4.0	+4.0											
Freq.	100Hz	6.6kHz											
Q	L-S	H-S											
<p>L21: CrunCh_EG</p> <p>Makes a moderately distorted crunch electric guitar sound distinctive.</p>	<table border="1"> <thead> <tr> <th></th> <th>LO</th> <th>HI</th> </tr> </thead> <tbody> <tr> <td>Gain</td> <td>-2.0</td> <td>+6.0</td> </tr> <tr> <td>Freq.</td> <td>120Hz</td> <td>4kHz</td> </tr> <tr> <td>Q</td> <td>0.7</td> <td>1.4</td> </tr> </tbody> </table>		LO	HI	Gain	-2.0	+6.0	Freq.	120Hz	4kHz	Q	0.7	1.4
	LO	HI											
Gain	-2.0	+6.0											
Freq.	120Hz	4kHz											
Q	0.7	1.4											
<p>L22: OverDrvEG</p> <p>Makes a mellow overdriven electric guitar sound fatter.</p>	<table border="1"> <thead> <tr> <th></th> <th>LO</th> <th>HI</th> </tr> </thead> <tbody> <tr> <td>Gain</td> <td>+6.0</td> <td>+7.0</td> </tr> <tr> <td>Freq.</td> <td>310Hz</td> <td>1.3kHz</td> </tr> <tr> <td>Q</td> <td>1.5</td> <td>1.1</td> </tr> </tbody> </table>		LO	HI	Gain	+6.0	+7.0	Freq.	310Hz	1.3kHz	Q	1.5	1.1
	LO	HI											
Gain	+6.0	+7.0											
Freq.	310Hz	1.3kHz											
Q	1.5	1.1											
<p>L23: Dist.EG</p> <p>Makes a hardly distorted electric guitar sound distinctive.</p>	<table border="1"> <thead> <tr> <th></th> <th>LO</th> <th>HI</th> </tr> </thead> <tbody> <tr> <td>Gain</td> <td>+6.0</td> <td>+4.0</td> </tr> <tr> <td>Freq.</td> <td>370Hz</td> <td>3.6kHz</td> </tr> <tr> <td>Q</td> <td>L-S</td> <td>10</td> </tr> </tbody> </table>		LO	HI	Gain	+6.0	+4.0	Freq.	370Hz	3.6kHz	Q	L-S	10
	LO	HI											
Gain	+6.0	+4.0											
Freq.	370Hz	3.6kHz											
Q	L-S	10											
<p>L24: Metal_EG</p> <p>Makes a high-gain metal sound distinctive.</p>	<table border="1"> <thead> <tr> <th></th> <th>LO</th> <th>HI</th> </tr> </thead> <tbody> <tr> <td>Gain</td> <td>+3.0</td> <td>+12.0</td> </tr> <tr> <td>Freq.</td> <td>230Hz</td> <td>14kHz</td> </tr> <tr> <td>Q</td> <td>0.7</td> <td>H-S</td> </tr> </tbody> </table>		LO	HI	Gain	+3.0	+12.0	Freq.	230Hz	14kHz	Q	0.7	H-S
	LO	HI											
Gain	+3.0	+12.0											
Freq.	230Hz	14kHz											
Q	0.7	H-S											
<p>L25: Stroke_AG</p> <p>Suppresses a hole resonance of an acoustic guitar and makes a code stroke sound powerful.</p>	<table border="1"> <thead> <tr> <th></th> <th>LO</th> <th>HI</th> </tr> </thead> <tbody> <tr> <td>Gain</td> <td>-9.0</td> <td>+8.0</td> </tr> <tr> <td>Freq.</td> <td>100Hz</td> <td>9kHz</td> </tr> <tr> <td>Q</td> <td>0.7</td> <td>1.2</td> </tr> </tbody> </table>		LO	HI	Gain	-9.0	+8.0	Freq.	100Hz	9kHz	Q	0.7	1.2
	LO	HI											
Gain	-9.0	+8.0											
Freq.	100Hz	9kHz											
Q	0.7	1.2											
<p>L26: Arpeg.EAG</p> <p>Controls the arpeggio code balance of an electro-acoustic guitar.</p>	<table border="1"> <thead> <tr> <th></th> <th>LO</th> <th>HI</th> </tr> </thead> <tbody> <tr> <td>Gain</td> <td>-2.0</td> <td>+3.0</td> </tr> <tr> <td>Freq.</td> <td>210Hz</td> <td>9.4kHz</td> </tr> <tr> <td>Q</td> <td>L-S</td> <td>0.1</td> </tr> </tbody> </table>		LO	HI	Gain	-2.0	+3.0	Freq.	210Hz	9.4kHz	Q	L-S	0.1
	LO	HI											
Gain	-2.0	+3.0											
Freq.	210Hz	9.4kHz											
Q	L-S	0.1											
<p>L27: Arpeg.AG</p> <p>Suppresses a hole resonance of an acoustic guitar and makes an arpeggio brighter.</p>	<table border="1"> <thead> <tr> <th></th> <th>LO</th> <th>HI</th> </tr> </thead> <tbody> <tr> <td>Gain</td> <td>-7.0</td> <td>+5.0</td> </tr> <tr> <td>Freq.</td> <td>530Hz</td> <td>4.4kHz</td> </tr> <tr> <td>Q</td> <td>7.1</td> <td>H-S</td> </tr> </tbody> </table>		LO	HI	Gain	-7.0	+5.0	Freq.	530Hz	4.4kHz	Q	7.1	H-S
	LO	HI											
Gain	-7.0	+5.0											
Freq.	530Hz	4.4kHz											
Q	7.1	H-S											
<p>L28: Brass_Sec</p> <p>Controls the balance of brass instruments (such as trumpets, trombones. etc.).</p>	<table border="1"> <thead> <tr> <th></th> <th>LO</th> <th>HI</th> </tr> </thead> <tbody> <tr> <td>Gain</td> <td>-3.0</td> <td>+4.0</td> </tr> <tr> <td>Freq.</td> <td>100Hz</td> <td>5.6kHz</td> </tr> <tr> <td>Q</td> <td>2.5</td> <td>5.0</td> </tr> </tbody> </table>		LO	HI	Gain	-3.0	+4.0	Freq.	100Hz	5.6kHz	Q	2.5	5.0
	LO	HI											
Gain	-3.0	+4.0											
Freq.	100Hz	5.6kHz											
Q	2.5	5.0											
<p>L29: W.WindSec</p> <p>Makes the mid frequency range of woodwind instruments (such as clarinets, oboe, etc.) richer.</p>	<table border="1"> <thead> <tr> <th></th> <th>LO</th> <th>HI</th> </tr> </thead> <tbody> <tr> <td>Gain</td> <td>+3.0</td> <td>+4.0</td> </tr> <tr> <td>Freq.</td> <td>125Hz</td> <td>260Hz</td> </tr> <tr> <td>Q</td> <td>L-S</td> <td>2.2</td> </tr> </tbody> </table>		LO	HI	Gain	+3.0	+4.0	Freq.	125Hz	260Hz	Q	L-S	2.2
	LO	HI											
Gain	+3.0	+4.0											
Freq.	125Hz	260Hz											
Q	L-S	2.2											

<p>L30: Male_Vo</p> <p>Effective for a male vocal</p>	<table border="1"> <thead> <tr> <th></th> <th>LO</th> <th>HI</th> </tr> </thead> <tbody> <tr> <td>Gain</td> <td>+2.0</td> <td>+3.0</td> </tr> <tr> <td>Freq.</td> <td>2kHz</td> <td>6.2kHz</td> </tr> <tr> <td>Q</td> <td>0.5</td> <td>H-S</td> </tr> </tbody> </table>		LO	HI	Gain	+2.0	+3.0	Freq.	2kHz	6.2kHz	Q	0.5	H-S
	LO	HI											
Gain	+2.0	+3.0											
Freq.	2kHz	6.2kHz											
Q	0.5	H-S											
<p>L31: Female_Vo</p> <p>Effective for a female vocal</p>	<table border="1"> <thead> <tr> <th></th> <th>LO</th> <th>HI</th> </tr> </thead> <tbody> <tr> <td>Gain</td> <td>-5.0</td> <td>+4.0</td> </tr> <tr> <td>Freq.</td> <td>170Hz</td> <td>5.8kHz</td> </tr> <tr> <td>Q</td> <td>0.7</td> <td>H-S</td> </tr> </tbody> </table>		LO	HI	Gain	-5.0	+4.0	Freq.	170Hz	5.8kHz	Q	0.7	H-S
	LO	HI											
Gain	-5.0	+4.0											
Freq.	170Hz	5.8kHz											
Q	0.7	H-S											
<p>L32: Chorus</p> <p>Effective for a whole chorus part by emphasizing the high frequency range.</p>	<table border="1"> <thead> <tr> <th></th> <th>LO</th> <th>HI</th> </tr> </thead> <tbody> <tr> <td>Gain</td> <td>-5.0</td> <td>+5.0</td> </tr> <tr> <td>Freq.</td> <td>120Hz</td> <td>10kHz</td> </tr> <tr> <td>Q</td> <td>0.7</td> <td>H-S</td> </tr> </tbody> </table>		LO	HI	Gain	-5.0	+5.0	Freq.	120Hz	10kHz	Q	0.7	H-S
	LO	HI											
Gain	-5.0	+5.0											
Freq.	120Hz	10kHz											
Q	0.7	H-S											
<p>L33: SpeeCh</p> <p>Makes a narration clear.</p>	<table border="1"> <thead> <tr> <th></th> <th>LO</th> <th>HI</th> </tr> </thead> <tbody> <tr> <td>Gain</td> <td>ON</td> <td>+3.0</td> </tr> <tr> <td>Freq.</td> <td>180Hz</td> <td>10kHz</td> </tr> <tr> <td>Q</td> <td>HPF</td> <td>H-S</td> </tr> </tbody> </table>		LO	HI	Gain	ON	+3.0	Freq.	180Hz	10kHz	Q	HPF	H-S
	LO	HI											
Gain	ON	+3.0											
Freq.	180Hz	10kHz											
Q	HPF	H-S											
<p>L34: Digi.Mix</p> <p>Makes an analog open-reel or cassette tape sound closer to a digital sound.</p>	<table border="1"> <thead> <tr> <th></th> <th>LO</th> <th>HI</th> </tr> </thead> <tbody> <tr> <td>Gain</td> <td>+5.0</td> <td>+6.0</td> </tr> <tr> <td>Freq.</td> <td>100Hz</td> <td>12kHz</td> </tr> <tr> <td>Q</td> <td>L-S</td> <td>H-S</td> </tr> </tbody> </table>		LO	HI	Gain	+5.0	+6.0	Freq.	100Hz	12kHz	Q	L-S	H-S
	LO	HI											
Gain	+5.0	+6.0											
Freq.	100Hz	12kHz											
Q	L-S	H-S											
<p>L35: AnalogMix</p> <p>Cuts the high frequency range and provides an opposite character to L34.</p>	<table border="1"> <thead> <tr> <th></th> <th>LO</th> <th>HI</th> </tr> </thead> <tbody> <tr> <td>Gain</td> <td>ON</td> <td>ON</td> </tr> <tr> <td>Freq.</td> <td>250Hz</td> <td>8kHz</td> </tr> <tr> <td>Q</td> <td>HPF</td> <td>LPF</td> </tr> </tbody> </table>		LO	HI	Gain	ON	ON	Freq.	250Hz	8kHz	Q	HPF	LPF
	LO	HI											
Gain	ON	ON											
Freq.	250Hz	8kHz											
Q	HPF	LPF											
<p>L36: Telephone</p> <p>Emphasizes the mid range only to provide a telephone receiver sound.</p>	<table border="1"> <thead> <tr> <th></th> <th>LO</th> <th>HI</th> </tr> </thead> <tbody> <tr> <td>Gain</td> <td>ON</td> <td>ON</td> </tr> <tr> <td>Freq.</td> <td>1.2kHz</td> <td>5.6kHz</td> </tr> <tr> <td>Q</td> <td>HPF</td> <td>LPF</td> </tr> </tbody> </table>		LO	HI	Gain	ON	ON	Freq.	1.2kHz	5.6kHz	Q	HPF	LPF
	LO	HI											
Gain	ON	ON											
Freq.	1.2kHz	5.6kHz											
Q	HPF	LPF											

Tips:

“L-S” (Low shelving type)

This equalizer affects all frequencies below a specified frequency when applying boost or cut.

“H-S” (High shelving type)

This equalizer affects all frequencies below a specified frequency when applying boost or cut.

“LPF” (Low pass filter)

This filter passes frequencies below a cut-off frequency while cuts frequencies above the frequency.

“HPF” (High pass filter)

This filter passes frequencies below a cut-off frequency while cuts frequencies above the frequency.

Setting Effects

The VF80EX provides 38 digital effect types used for the loop effect and 6 types used for the insert effect. As you can select any type and adjust parameter settings for each type, comprehensive effect processing is possible.

Employing the Fostex A.S.P. (Fostex Advanced Signal Processing Technology*), the internal DSP multi-effect processor realizes superb ambience effects. In addition, the newly developed "A.S.P. +" achieves simulations of microphones/amplifiers with overwhelming reality.

<About "Loop effect" and "Insert effect">

Using a loop effect you can process sound recorded on tracks during track bouncing (ping-pong) or mixdown. The processed sound is recorded to the other track(s) of the unit or external master recorder.

Using an insert effect, you can process sound on any of tracks 1 through 6 using a distortion or simulation effect, and rerecord the processed sound to the same track.

* A. S. P. (Fostex Advanced Signal Processing Technology)



The A. S. P. is an exclusive new digital effect processing technology designed by Fostex.

This method extracts maximum efficiency from the limited DSP power.

It achieves an overwhelmingly high density Early Reflection sound and wonderfully smooth High Dump response through the H. F. A. (Harmonic Feedback Algorithm). Also, it carries out an elaborate reverb simulation with clear sounds through the H. D. L. P. (Hi-Density Logarithmic Processing), which eliminates the mutual interference between the numerous integrated delay modules and reduce the impurity and girt of the sound.

* H. F. A. (Harmonic Feedback Algorithm)

There is one of indispensable elements in the natural echo called "Early Reflection Sound," which is usually sacrificed in commercial reverb products in order to reduce costs. (In practice, the Early Reflection Sound means the very first reverberated sound that bounces back from walls, floors and ceilings of concert halls). The entire reverb sound quality depends on this Early Reflection Sound and how closely it can resemble the real echo. The H. F. A. is an algorithm that enables the effect unit to reproduce a clear and natural Early Reflection Sound by applying an ideal harmonic feedback to each delay module.

* H. D. L. P. (Hi-Density Logarithmic Processing)

The reverb sounds consist of lots of small delay elements combined in a complex way, which are produced by many delay modules inside the effect unit. In order to obtain smooth and comfortable reverb sounds, it is very important to efficiently organize the relationship between each delay module and minimize negative mutual interference. The H. D. L. P. is a technology which applies efficient logarithmic processing to each delay module, so that they can work in the most efficient way in order to eliminate harmful reverb elements and roughness. This makes it possible to establish high density and transparent sounds.

About "A.S.P.+"

Combining the ambience effect technology established through the development of "A.P.S." with acoustic theories accumulated through the development of transducers such as monitor speakers for many years, Fostex developed a unique simulation algorithm engine called "A.S.P.+", which performs overwhelmingly realistic microphone/amplifier simulation.

To simulate a microphone, the frequency response of the microphone, which is the most essential factor that decides the sound character of each famous/popular microphone, must be reproduced correctly. To get this, "A.P.S.+" carries out a double accuracy operation for each frequency range using the unique "D.A.O." (Double Accuracy Operation).

Regarding a guitar amplifier, the peak and dip of the specific frequencies, as well as feedback of the peak frequency's harmonics, are the most essential factors that decide the sound character of each famous/popular amplifier. To simulate such a unique character, "A.P.S.+" carries out a double accuracy operation for each frequency range using the "D.A.O." (Double Accuracy Operation) to simulate the frequency curve, as well as carries out harmonics feedback processing using the "H.F.A." (Harmonics Feedback Algorithm).

Before describing detail for the VF80EX effect setting, we briefly explain each effect type (reverb, delay, chorus, flanger, distortion and simulator).

Reverb:

The so called Reverb effect consists of various reflection sounds mixed together. For example, when you clap your hands in a tunnel, you will hear the sound linger even after you stop clapping your hands. This is the Reverb.

The sounds we normally hear in daily life have three types of sounds mixed together, i.e., "Direct sound," "Early Reflection sound" and "Late Reflection sound."

The Direct sound means the sound directly reaches the ears from the sound source. The Early Reflection sound means the sound that comes after the Direct sound and has rebound off the wall of the tunnel up to a few times. The Late Reflection sound means that the sound rebounds many times long after the Direct sound has disappeared. Our ears normally hear the "Direct sound" - "Early Reflection sound" - "Late Reflection sound" in the order.

Delay:

This is the effect to added a delayed sound to the original sound. You can obtain a richer sound or completely change the original source sound by using the Delay.

Chorus:

This makes the one original sound appear to have many sources. The Chorus is used to widen or thicken the original sound.

Flanger:

The Flanger is one of applications of the Delay.

This is used to create a sound like a jet airplane ascending or descending.

Distortion:

The distortion effect distorts the sound and adds harmonics. Four types of the distortion effect are provided: the guitar distortion, bass distortion, drum distortion and voice distortion. The distortion is used for the insert effect.

Simulation:

Simulators for famous guitar amplifiers and microphones are provided. You can get a familiar distortion sound of a famous guitar amplifier or a popular microphone sound. A simulator can be used for the insert effect.

How to make the loop effect setting

There are two methods for using the internal effect processor of the VF80EX; "**loop effect**" and "**insert effect**".

The **loop effect** allows you to apply a desired effect to track signals during track bounce (ping-pong) operation to the other tracks or mixdown operation to an external master recorder.

The **insert effect** is applied when rerecording any of recorded tracks 1 through 6.

The following describes how to make settings for the loop effect. See "**Advanced Operations**" on page 84 for details about the insert effect.

<Note>

The effect settings described here are only available to Tracks 1 through 6.

On Track 7/8, the dedicated "**Mastering processing**" is built in and you can apply the reverb, compressor, etc. while transferring audio on the master tracks (7/8) to an external recorder. See "**Advanced Operations**" for details.

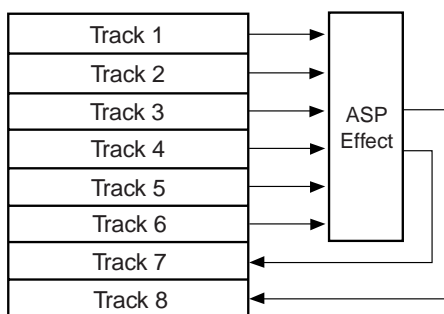

Bouncing tracks 1 through 6 to tracks 7 and 8.

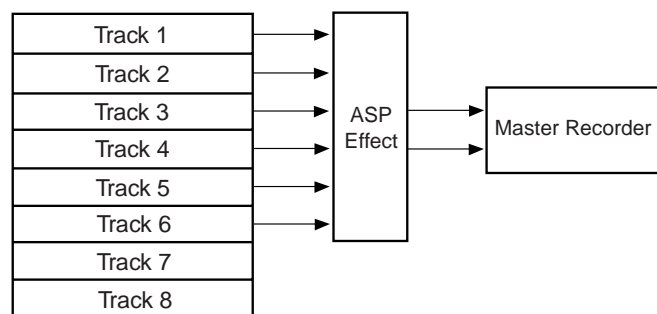

Mixing down tracks 1 through 6 and recording to an external master recorder.

<Hint>

When editing the loop effect setting, pressing the [EFFECT] key after turning on the power cycles the screen between "Effect send level setting screen", "Effect type/parameter setting screen" and "Effect send pre/post setting screen", as shown right.

<Note>

If you select one of effect types L39 through L44, the "Effect type/parameter setting screen" is shown and pressing the [EFFECT] key does not change the screen.

This is because effect types L39 through L44 are only used as insert effects and do not have the "Effect send level setting screen" and "Effect send pre/post setting screen" See "Advanced Operations" on page 84 for details about the insert effect.

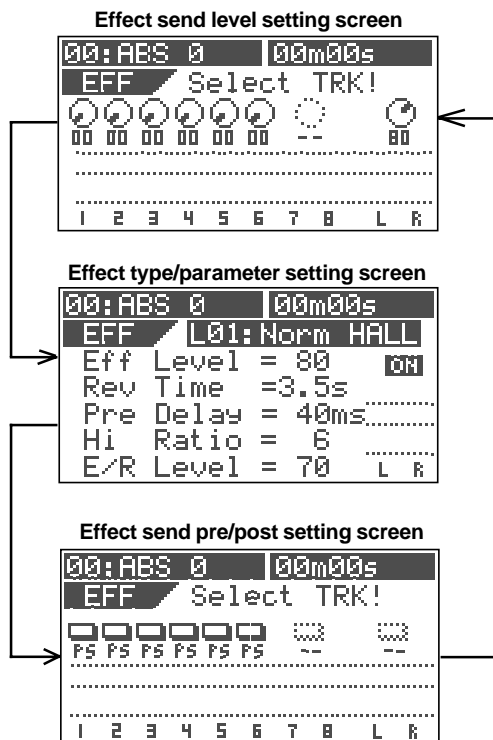

Setting effect send levels

You can set send levels from Tracks 1 through 6 to the internal A.S.P. effect processor.

- 1 Press the [EFFECT] key to bring up the send level setting screen.**

If you have not edited any track parameter for effect send, EQ or pan setting after turning on the power last time, the message prompting to select a track ("Select TRK!") flashes, as well as the [TRACK STATUS/TRACK SEL] keys for Tracks 1 through 6 on the panel flash.

If you have edited any track parameter for effect send, EQ or pan setting after turning on the power last time, the icon for the previously edited track is highlighted, showing that it can be edited.

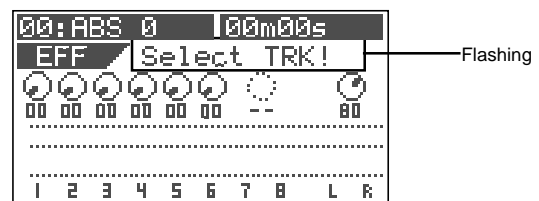

- 2 Select the desired track by pressing the corresponding [TRACK STATUS/TRACK SEL] key (or using the [CURSOR </>] keys).**

The icon of the selected track is highlighted, indicating that you can edit it.

In the default settings, the send levels for Tracks 1 through 6 are "00" while the level for Master is "80."

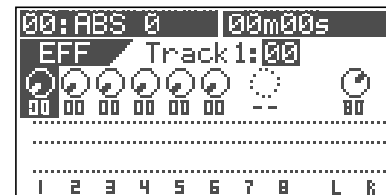

- 3 Use the [JOG] dial to adjust the send level value.**

The knob icon also rotates according to the level value. When the level is set to "00", no signal is sent to the effect processor.

- Editable tracks: Tracks 1 through 6
- Level range: 00 through 99 in 1 step
- Default level: Tracks 1 through 6: 00, Master: 80

- 4 To edit the send level for another track, repeat steps 2 and 3 above.**

- 5 To edit the effect send master level, press the [STATUS/SEL] key of the master to highlight the master level icon, and then use the [JOG] dial to edit the value. The default level value is "80."**

- 6 After completing send level settings, press the [EXIT/NO] key.**

The LCD display returns to the Normal screen.

Selecting an effect type

<Note>

Changing the effect preset may mute the sound momentarily!

Effect presets of the internal effect processor shown above are classified into three types; *ambience/delay type (No. 1 through 28)*, *modulation/pitch type (No. 29 through 36)*, *pitch type (No. 37 and 38)* and *distortion/simulation type (No. 39 through 44)*.
If you switch the effect preset between the three types above, the audio is momentarily muted.

- 1 Press the [EFFECT] key to bring up the effect type/parameter setting screen.

The first time you bring up the screen, "L01: Norm HALL" is selected as the effect type.

From the second time on when bringing up the screen, the previously selected effect type is selected.

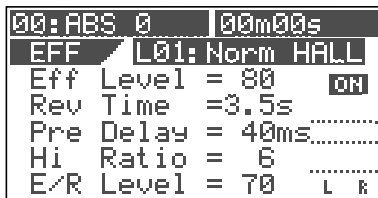

- 2 Use the [JOG] dial to select the desired effect type.
For the loop effect, you can select among L01 through L38.
Effect types L39 through L44 are used for the insert effect (described later).
When you select a type other than the current type, the type flashes.

- 3 Press the [ENTER/YES] key after selecting the effect type.

Now you can edit the first parameter.
In the example below, the "Eff Level" value is highlighted showing that it can be edited.

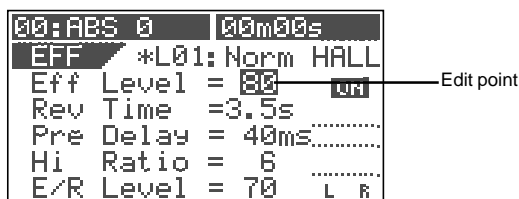

- 4 Use the [JOG] dial to select a value for the highlighted parameter.
See "Effect parameter details" about the available parameter values.
- 5 To set a value for another parameter, use the [CURSOR ▼] key to select a parameter to be edited, and then use the [JOG] dial to select a value.
- 6 After completing the settings, press the [EXIT/NO] key.
The VF80EX exits the edit mode and the LCD display returns to the Normal screen.

Selecting Pre/Post of the effect send

You can select the send signals from Tracks 1 through 6 pre- or post- fader.

When selecting Post, a signal after the track fader is sent to the effect processor. So if you set the fader completely down, no signal is sent to the effect processor.

When selecting Pre, a signal before the track fader is sent to the effect processor. So even if you set the fader completely down, the signal is sent to the effect processor.

- 1 Press the [EFFECT] key to bring up the pre/post setting screen.

If you have not edited any track parameter for effect send, EQ or pan setting after turning on the power last time, the message prompting to select a track ("Select TRK!") flashes, as well as the [TRACK STATUS/TRACK SEL] keys for Tracks 1 through 6 on the panel flash.

If you have edited any track parameter for effect send, EQ or pan setting after turning on the power last time, the switch icon for the previously edited track is highlighted, showing that it can be edited.

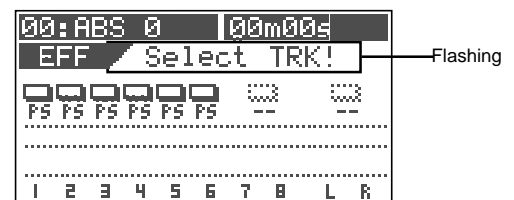

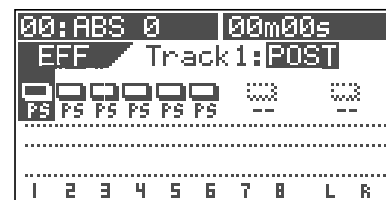

- 2 Select the desired track by pressing the corresponding [TRACK STATUS/TRACK SEL] key (or using the [CURSOR ◀/▶] keys).

The switch icon of the selected track is highlighted, indicating that you can edit it.
In the default settings, all Tracks 1 through 6 are set to "Post."



- 3 Use the [JOG] dial to select "Pre" or "Post."
The icon changes according to the selection as below.

	Pre fader signal is sent to the effect processor.
	Post fader signal is sent to the effect processor.
<ul style="list-style-type: none"> • Selectable tracks: Tracks 1 through 6 • Setting values: PRE or POST (the default is POST). 	

Turning the effect processor on or off

You can select the on or off of the effect processor.

- **To turn on the effect processor**

Press the [EFFECT/ON/OFF] key while holding down the [SHIFT] key to illuminate the [EFFECT/ON/OFF] key.

The effect processor is turned on and you can hear "wet" sound.

- **To turn off the effect processor**

Press the [EFFECT/ON/OFF] key while holding down the [SHIFT] key to illuminate the [EFFECT/ON/OFF] key.

The effect processor is turned off and you can hear "dry" sound.

You can also see the on/off status of the effect processor in the effect type/parameter setting screen.

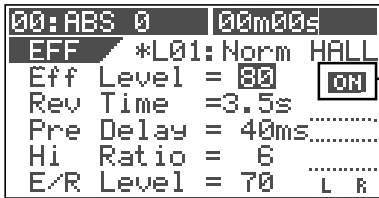

This icon shows the on/off status of the effect processor.

About the effect types

Effect types L01 through L38 are used for the loop effect, while L39 through L44 are used for the insert effect.

	Name	Parameter type	Explanation
L01	Norm HALL	REVERB	Standard hall reverb; detailed and transparent, with a moderate amount of early reflections.
L02	Pres HALL	REVERB	Hall reverb with presence and definition.
L03	Wet HALL	REVERB	Hall reverb with restrained high-frequency and a refreshing atmosphere.
L04	NoER HALL	REVERB	All-purpose hall reverb with no early reflections, and even decay of all frequencies.
L05	Lo-F HALL	REVERB	Hall reverb with lingering low-frequency reverberation.
L06	STADIUM	REVERB	Stadium reverb characterized by long early reflections.
L07	AUDITORIUM	REVERB	Reverb simulating an auditorium with suppressed reverberation.
L08	HALL WAY	REVERB	Reverb with a long pre-delay, creating the impression of an extended space.
L09	Norm ROOM	REVERB	Room reverb simulating a moderate space with some sparkle.
L10	Dead ROOM	REVERB	Room reverb simulating a narrow and dead room. Adding a slight amount will give warmth to the sound.
L11	Pres ROOM	REVERB	All-purpose room reverb, with good definition and few early reflections.
L12	DrumBOOTH	REVERB	Room reverb simulating a drum booth.
L13	GARAGE	REVERB	Room reverb simulating a narrow and live space like a garage, with crisp presence.
L14	NormPLATE	REVERB	Modern-sounding plate reverb with wide bandwidth.
L15	Old PLATE	REVERB	Standard plate reverb with the character of older plate units.
L16	PresPLATE	REVERB	Plate reverb with good definition and extended high-frequencies.
L17	Wet PLATE	REVERB	Plate reverb with a gentle character.
L18	DigiPLATE	REVERB	Plate reverb that emphasizes a digital character, with metallic early reflections.
L19	NormVOCAL	REVERB	All-purpose hall reverb with no early reflections, and uniform decay at all frequencies.
L20	PresVOCAL	REVERB	Short reverberation with extended high frequency is added to the early reflections of an ideal vocal booth. Since this adds sparkle to the sound, it is effective when you wish to bring the vocal to the forefront.
L21	SoloVOCAL	REVERB	Plate-like reverb is added to a spacious short delay. This blends well with any genre of music.
L22	Arena VOC	REVERB	Gentle reverb is added to spacious stadium-type early reflections.
L23	Arena CHO	REVERB	Short reverb with extended high frequency is added to spacious stadium-type early reflections. Effective on chorus parts.
L24	KARAOKE	REVERB	All-purpose reverb (karaoke style) that makes any vocal sound professional.
L25	MnDL-HALL	DLY+REVERB	A combined effect of mono delay and hall reverb.
L26	MnDL-PLT	DLY+REVERB	A combined effect of mono delay and plate reverb.
L27	PnDL-HALL	DLY+REVERB	A combined effect of panning delay and hall reverb.
L28	PnDL-PLT	DLY+REVERB	A combined effect of panning delay and plate reverb.
L29	MonoDELAY	DELAY	Mono delay
L30	PanDELAY	DELAY	Panning delay
L31	MonoBpmDL	BPM DELAY	Mono delay. Specify BPM and note value to set the delay time.
L32	PanBpmDL	BPM DELAY	Panning delay. Specify BPM and note value to set the delay time.
L33	Short DL	SHORT DELAY	Short delay that allows you to set the delay time precisely.
L34	DOUBLING	DOUBLING	Doubling that allows you to set separate delay times for L and R.
L35	CHORUS	CHORUS	Produces a chorus effect. A doubling effect can also be added.
L36	FLANGE	FLANGE	Produces a flanging effect.
L37	MonoPITCH	MONO PITCH	Pitch shift adjustable in a +/-2 octave range.
L38	DlyPITCH	DELAY PITCH	Pitch shift with a feedback delay, allowing strange effects to be produced.
L39	Dist Gtr	DISTORTION	Distortion sound for a guitar. (See "Advanced Operations" on page 84.)
L40	Dist Bass	DISTORTION	Distortion sound for a bass. (See "Advanced Operations" on page 84.)
L41	Dist Drum	DISTORTION	Distortion sound for drums. (See "Advanced Operations" on page 84.)
L42	Dist Voice	DISTORTION	Distortion sound for a voice. (See "Advanced Operations" on page 84.)
L43	Gtr Amp Sim	SIMULATION	You can simulate popular guitar amplifier sounds. (See "Advanced Operations" on page 84.)
L44	Mic Sim	SIMULATION	You can simulate famous microphone sounds. (See "Advanced Operations" on page 84.)

Effect parameter details

The parameters that can be adjusted will depend on the parameter type.

The following describes parameters for effect types L01 through L38 used for the loop effect.

See "Advanced Operations" on page 84 for details about parameters for effect types L39 through L44 used for the insert effect.

Reverb effect parameters (parameter type: REVERB)

For effect types 1--24 of the preceding "Effect type" table, the following five parameters can be adjusted.

- | | |
|--------------|---|
| 1. Eff Level | Adjust the effect return level: 0-99 |
| 2. Rev Time | Adjust the length of reverberation. Range: 0.1-9.9 seconds |
| 3. Pre Delay | Adjust the time from the original sound until reverberation begins. Range: 0-100 ms |
| 4. Hi Ratio | Adjust the decay ratio of the high frequencies. Range: 0-10 |
| 5. E/R Level | Adjust the volume of the early reflections. Range: 0-99 |

Delay+reverb effect parameters (parameter type: DELAY+REVERB)

For effect types 25-28 of the preceding "Effect type" table, the following five parameters can be adjusted.

- | | |
|---------------|--|
| 1. Eff Level | Adjust the effect return level: 0-99 |
| 2. Delay Time | Adjust the delay time: Range: 1-230 ms |
| 3. Feedback | Adjust the number of delay repeats. Range: 0-99 |
| 4. Delay Bal | Adjust the delay balance. Range: 0-99 |
| 5. Rev Time | Adjust the length of reverberation. Range: 0.1-9.9 seconds |

Delay effect parameters (parameter type: DELAY)

For effect types 29 and 30 of the preceding "Effect type" table, the following five parameters can be adjusted.

- | | |
|---------------|--|
| 1. Eff Level | Adjust the effect return level: 0-99 |
| 2. Delay Time | Adjust the delay time. Range: 1-680 ms |
| 3. Feedback | Adjust the number of delay repeats. Range: 0-99 |
| 4. Hi Ratio | Adjust the decay ratio of the high frequencies. Range: 0-10 |
| 5. Filter | Adjust the tone of the delay sound. Range: L9-L1, OFF, H1-H9 |
- * L1-L9 = LPF (larger numbers will lower the cutoff frequency)
 * H1-H9 = HPF (larger numbers will raise the cutoff frequency)

BPM delay effect parameters (parameter type: BPM DELAY)

For effect types 31 and 32 of the preceding "Effect type" table, the following five parameters can be adjusted.

- | | |
|--------------|--|
| 1. Eff Level | Adjust the effect return level: 0-99 |
| 2. BPM | Adjust the BPM. Range: 30-250 bpm |
| 3. Note | If the delay time exceeds 680 ms, "I" is shown.
Select the note value for the delay. Range: 24, 16, 8T, 16...8, 4T, 8., 4, 2T, 4., 2, 2., 1
* 24 = 16th note sextuplets, 16 = 16th notes, 8T = 8th note triplets, 16. = dotted sixteenth notes,
8 = 8th notes, 4T = quarter note triplets, 8. = dotted eighth notes,
4 = quarter notes, 2T = half-note triplets, 4. = dotted quarter notes, 2 = half notes
* The "." shown in the ninth character of the LCD indicates a dotted note.
* The "T" shown in the ninth character of the LCD indicates a triplet. |
| 4. Feedback | Adjust the number of delay repeats. Range: 0-99 (100 steps in increments of 1) |
| 5. Filter | Adjust the tone of the delay sound. Range: L9-L1, OFF, H1-H9 |
- * L1-L9 = LPF (larger numbers will lower the cutoff frequency)
 * H1-H9 = HPF (larger numbers will raise the cutoff frequency)

Short delay effect parameters (parameter type: SHORT DELAY)

For effect type 33 of the preceding "Effect type" table, the following five parameters can be adjusted.

- | | |
|---------------|--|
| 1. Eff Level | Adjust the effect return level: 0-99 |
| 2. Delay Time | Adjust the delay time. Range: 0.1-9.9 ms, 10-99 ms, 100-200 ms |
| 3. Feedback | Adjust the number of delay repeats. Range: 0-99 |
| 4. Hi Ratio | Adjust the decay ratio of the high frequencies. Range: 0-10 |
| 5. Filter | Adjust the tone of the delay sound. Range: L9-L1, OFF, H1-H9 |
- * L1-L9 = LPF (larger numbers will lower the cutoff frequency)
 * H1-H9 = HPF (larger numbers will raise the cutoff frequency)

Doubling effect parameters (parameter type: DOUBLING)

For effect type 34 of the preceding "Effect type" table, the following four parameters can be adjusted.

- | | |
|--------------|---|
| 1. Eff Level | Adjust the effect return level: 0-99 |
| 2. Lch Delay | Adjust the delay time of the L channel. Range: 0.1-9.9 ms, 10-99 ms, 100-200 ms |
| 3. Rch Delay | Adjust the delay time of the R channel. Range: 0.1-9.9 ms, 10-99ms, 100-200 ms |
| 4. Filter | Adjust the tone of the delay sound. Range: L9-L1, OFF, H1-H9 |
- * L1-L9 = LPF (larger numbers will lower the cutoff frequency)
 * H1-H9 = HPF (larger numbers will raise the cutoff frequency)

Chorus effect parameters (parameter type: CHORUS)

For effect type **35** of the preceding "Effect type" table, the following five parameters can be adjusted.

- | | |
|-----------------------|---|
| 1. Eff Level | Adjust the effect return level: 0-99 |
| 2. Depth | Adjust the chorus depth. Range: 0-99 |
| 3. Double Time | Adjust the time difference of the doubling effect. Range: 0-99 |
| 4. Double Lvl | Adjust the volume of the doubling effect. Range: 0-99 |
| 5. Filter | Adjust the tone of the delay sound. Range: L9-L1, OFF, H1-H9
* L1-L9 = LPF (larger numbers will lower the cutoff frequency)
* H1-H9 = HPF (larger numbers will raise the cutoff frequency) |

Flanger effect parameters (parameter type: FLANGE)

For effect type **36** of the preceding "Effect type" table, the following five parameters can be adjusted.

- | | |
|---------------------|---|
| 1. Eff Level | Adjust the effect return level: 0-99 |
| 2. Rate | Adjust the speed of modulation. Range: 0.01-2.00 Hz |
| 3. Depth | Adjust the depth of modulation. Range: 0-99 |
| 4. Mod Delay | Adjust the modulation delay. Range: 0-200 |
| 5. Feedback | Adjust the number of modulation repeats. Range: 0-99 |

Mono pitch effect parameters (parameter type: MONO PITCH)

For effect type **37** of the preceding "Effect type" table, the following four parameters can be adjusted.

- | | |
|---------------------|---|
| 1. Eff Level | Adjust the effect return level: 0-99 |
| 2. Pitch | Adjust the amount of pitch shift. Range: -24-0-+24
* +/-12 is one octave. +/-24 is two octaves. |
| 3. Adjust | Make fine adjustments to the amount of pitch shift. Range: -50-0-+50
* +50 is a semitone sharp. -50 is a semitone flat. |
| 4. Mode | Select the processing method. Range: 1-3 |

Delay pitch effect parameters (parameter type: DELAY PITCH)

For effect type **38** of the preceding "Effect type" table, the following five parameters can be adjusted.

- | | |
|----------------------|---|
| 1. Eff Level | Adjust the effect return level: 0-99 |
| 2. Pitct | Adjust the amount of pitch shift. Range: -24-0-+24
* +/-12 is one octave. +/-24 is two octaves. |
| 3. Adjust | Make fine adjustments to the amount of pitch shift. Range: -50-0-+50
* +50 is a semitone sharp. -50 is a semitone flat. |
| 4. Delay Time | Adjust the delay time until the pitch-shifted sound is heard. Range: 0-500 ms |
| 5. Feedback | Adjust the number of delay repeats. Range: 0-99 |

Scene memory

The VF80EX provides 100 Scene memories (S00 to S99) for each program. You can store a set of desired parameter settings to each memory. Items to be stored include all parameters set by mix parameter editing functions, as well as all track fader levels. In addition to 100 Scene memories, the VF80EX also provides 10 Temporary memories (T00 to T09) that can be used with all programs in common. Note that all settings stored in Temporary memories disappear when turning off the power.

You can give a desired title (name) with up to 16 alphanumeric or symbolic characters to each Scene/Temporary memory. (Note that up to 11 characters can be shown on the display.)

Storing the current scene

You can store the current scene (settings) to a Scene or Temporary memory by using the following procedure.

<Hint>

Scene memories (shown as S00 through S99 on the list) are retained even if the power is turned off, while Temporary memories (shown as T00 through T09 on the list) disappear when the power is turned off, though they do not disappear when changing the program. If you want to store a Temporary memory to a Scene memory (S00 to S99), recall the temporary number before turning off the power and store the settings to the desired Scene memory number.

1 Press the [SCENE] key.

The display shows the screen for selecting the desired scene number.

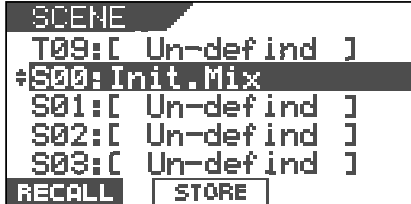

2 Use the [JOG] dial to select the desired scene number to which you want to store the current settings, and press the [TIME BASE SEL/F2] key while holding down the [SHIFT] key. (In the following example, "S01" is selected.)

The scene name of the program which you worked with before entering the scene memory mode is duplicated to the name of the selected scene number, whose leftmost character flashes, showing that it can be edited.

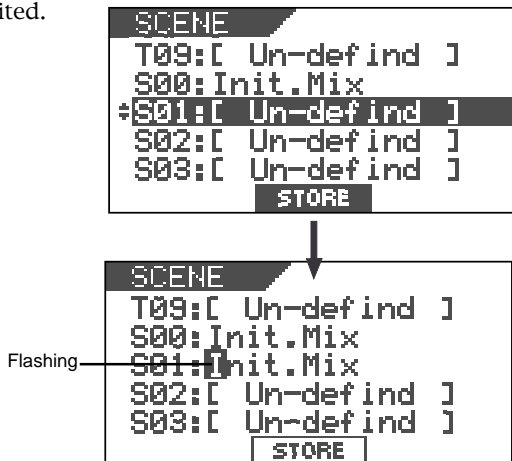

3 Enter the desired scene name by using the [JOG] dial for selecting a character and using the [CURSOR </>] keys for moving the editing (flashing) point.

You can specify a scene name with up to 16 alphanumeric or symbolic characters and can see up to 14 characters on the display. The following characters can be entered:

A to Z, a to z, 0 to 9, + - * / # & ! ? () [] < > : . , etc.

4 After completing the scene name entry, press the [TIME BASE SEL/F2] key while holding down the [SHIFT] key.

The display changes to the Normal display of the program whose scene name has just been set.

Recalling a scene

You can recall the settings stored in Scene or Temporary memories.

<Cautions>

- If the "Fader recall On/Off setting" menu described later is set to "OFF", when recalling a desired scene memory, fader settings are not recalled, while "Scene Recalled Fader RCL OFF" is momentarily shown on the screen.
- If the "Fader recall On/Off setting" menu is set to "ON", regardless of the current physical positions of track and master faders, the audio is output at the fader positions when they were stored. We suggest you to turn the monitor volume down when recalling a scene memory to prevent an accidentally accessing high-volume sound.

1 Press the [SCENE] key.

The display shows the screen for selecting the scene number.



- 2 Use the [JOG] dial to select the desired scene number to be recalled.
- 3 Press the [SETUP/F1] key while holding down the [SHIFT] key.
The selected scene is recalled and the display changes to the Normal display.

Deleting a scene

You can delete an unnecessary Scene or Temporary memory by using the following procedure.

<Notes>

- You cannot delete the memory in scene number 00. If you select scene number 00 and try to delete the memory, "DELETE" does not appear on the display.
- You cannot undo deleting a scene. Be sure not to select a wrong scene number to be deleted.

- 1 Press the [SCENE] key.
The display shows the scene number/title list.



- 2 Select a memory to be deleted using the [JOG] dial.
- 3 Press the [UNDO/REDO/F3] key while holding down the [SHIFT] key.
The message asking for confirmation to delete the scene appears and "Sure?" flashes.
To cancel to delete the mark, press the [EXIT/NO] key now.

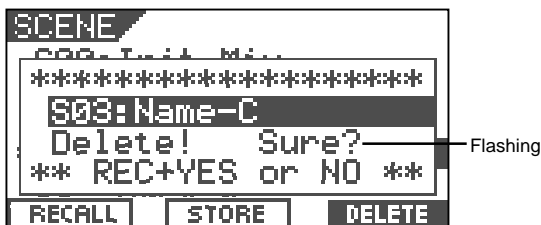

- 4 Press the [ENTER/YES] key while holding down the [RECORD] key.
The selected memory is deleted and the scene name changes to "[Un-defined]", showing that no memory is stored.
- 5 Press the [EXIT/NO] key.
The display returns to the Normal screen.

Fader adjust

After recalling a scene, the recalled fader level usually does not match the current physical fader position, you can move the physical faders to match the current fader positions of the scene. The following description is assumed that "Fader recall setting" of the setup mode is set to "Trk & Mst."

- 1 Press the [SCENE/FADER] key while holding down the [SHIFT] key.
The display shows the fader setting screen. The fader icon changes according to the relation between the physical fader position and recalled fader position, as show below.

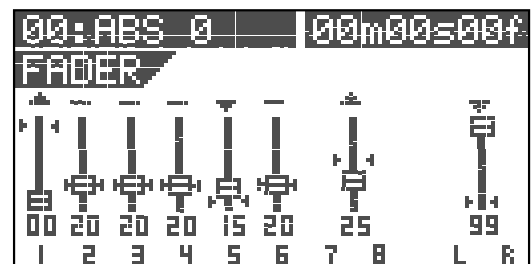

•The current physical fader position is lower than the recalled position.

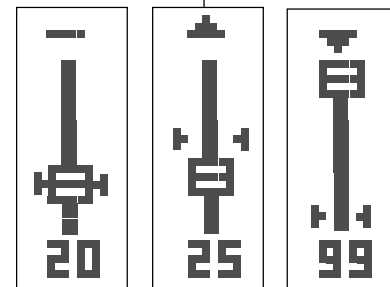

•The current physical fader position matches the recalled position.

•The current physical fader position is higher than the recalled position.

- 2 Move a physical fader manually to match the recalled (scene memory) position.
- 3 After adjusting all the fader positions, press the [EXIT/NO] key.

<Note>

If you recall a scene when "Fader recall setting" of the setup mode is set to "OFF", the current physical fader positions are valid.

Scene sequence

Using the scene sequence function, you can recall desired scene memories at the desired mark positions during playback. For example, you can recall scene memory 02 at "Bar 17/Beat 1" and scene memory 04 at "Bar 25/Beat 1", etc. To execute the scene sequence function, you must first assign scene (or temporary) memories to marks in the mark map. If you set the timebase to Bar/Beat/Clk, you can assign scene memories to be recalled to the musical positions (Bar/Beat/Clk numbers). Of course, you may set the timebase to ABS.

<Note>

You must store data to scene memories before assigning to the mark map.

Assigning scene memories to the mark map

In the following description, we assume that the timebase is set to Bar/Beat/Clk.

- 1 While the VF80EX is stopped, press the [SCENE SEQ/ MAP] key while holding down the [SHIFT] key.

The screen shows the mark map, in which the current marks are listed.

In the mark map example below, only scene memory 00 is assigned to mark 00. ("Non" means that no memory is assigned to the corresponding mark.)

MARK MAP			
00:	-2BAR 1/00		S00
01:	012BAR 1/00		Non
02:	020BAR 4/30		Non
03:	028BAR 6/46		Non
04:	046BAR 3/00		Non
LOCATE			

<Hint>

You can view mark titles instead of mark positions (in bar/beat/clock base or ABS time base) in the mark map. Pressing the [TIME BASE SEL] key while the mark map screen is shown switches mark positions and mark titles.

- 2 Select the desired mark using the [JOG] dial, and then press the [TIME BASE SEL/F2] key while holding down the [SHIFT] key.

The display shows the screen for editing the selected mark.

MARK MAP			
00:	-2BAR 1/00		S00
01:	012BAR 1/00		Non
02:	020BAR 4/30		Non
03:	028BAR 6/46		Non
04:	046BAR 3/00		Non
LOCATE EDIT DELETE			

MARK MAP MARK03 Edit			
028BAR	6/46CLK		
Name =	*****		
Scene =	Non		
Hit ENTER or EXIT			

- 3 Highlight "Non" using the [CURSOR </>] keys, and then select the desired scene number to be assigned to the mark using the [JOG] dial.

When selecting a scene number which holds data, its scene title is also shown below the scene number.

MARK MAP MARK03 Edit			
028BAR	6/46CLK		
Name =	*****		
Scene =	Non		
Hit ENTER or EXIT			

MARK MAP MARK03 Edit			
028BAR	6/46CLK		
Name =	*****		
Scene =	**		

Hit ENTER or EXIT			

Scene title

Scene number

Mark title

- 4 After selecting the scene number, press the [ENTER/ YES] key.

Repeat steps 1 through 4 to assign scene numbers to other marks.

In the example below, several scene numbers are assigned to marks and you are ready for executing the scene sequence function described later.

MARK MAP			
00:	-2BAR 1/00		S00
01:	012BAR 1/00		S02
02:	020BAR 4/30		S06
03:	028BAR 6/46		S04
04:	046BAR 3/00		S03
LOCATE EDIT DELETE			

- 5 Press the [EXIT/NO] key after assigning all desired scenes to marks.

Deleting a mark from the mark map

You can delete an unnecessary mark from the mark map.

<Note>

You cannot delete mark 00.

- 1** While the VF80EX is stopped, press the [SCENE SEQ/ MAP] key while holding down the [SHIFT] key.
The screen shows the mark map.
- 2** Highlight the desired mark using the [JOG] dial.
- 3** Press the [UNDO/REDO/F3] key while holding down the [SHIFT] key.
The message asking for confirmation to delete the mark appears and "Sure?" flashes.

To cancel to delete the mark, press the [EXIT/NO] key now.
- 4** Press the [ENTER/YES] key while holding down the [RECORD] key.
The map is deleted and the following marks are renumbered.

Scene sequence on/off selection

You can turn on or off the scene sequence function for selecting whether or not performing the scene sequence function using the mark map.

- 1** While the VF80EX is stopped, press the [SCENE SEQ] key.
The [SCENE SEQ] key lights in green, showing that the scene sequence function is active (ON).

Each time you press the [SCENE SEQ] key, ON and OFF alternates.

When turning on the scene sequence function, "SCENE SQ: ON" appears momentarily on the Normal screen and then the scene number is highlighted.

When turning off the scene sequence function, "SCENE SQ: OFF" appears momentarily on the Normal screen and then the highlighted scene number returns to the Normal screen.



Executing the scene sequence

If you start playback while the scene sequence function is active (ON), the scenes will be recalled according to the mark map.

<Note>

When executing the scene sequence, the fader positions may be recalled or not according to the fader recall mode setting in the setup mode (the default is "OFF"). For example, if you set the fader recall mode to "ON", both the track and master faders are automatically recalled every time the current scene changes. On the contrary, if you set the fader recall mode to "OFF" (the default mode), fader positions are not recalled so you can manually control fader positions as you like. We suggest you to make sure to set the fader recall mode suitably for your work before executing the scene sequence. See "Fader recall mode setting" on page 133 for details.

<Screen appearances during playback>

The following show the screen appearances during playback with the mark map in which scene number 02 (with the title "BBBB") is assigned to "Bar 12, Beat 1" and scene number 06 (with the title "CCCC") is assigned to "Bar 20, Beat 4."

```
00: Intro -2BAR 1J
P01: #0001
S00: Init.MixE
```

The unit starts playback from "Bar -2, Beat 1" with the settings stored in scene number 00 (Init Mix).

```
02: Guitar 12BAR 1J
P01: #0001
S02: BBBB
```

The unit recalls scene number 02 (BBBB) at "Bar 12, Beat 1" and continues playback.

```
05: Piano 20BAR 4J
P01: #0001
S06: CCCC
```

The unit recalls scene number 06 (CCCC) at "Bar 20, Beat 4" and continues playback.

<Note>

The effect preset may not be changed while the scene sequence function is active!

Effect presets of the internal effect processor are classified into three types; ambience/delay type (No. 1 through 28), modulation/pitch type (No. 29 through 36), pitch type (No. 37 and 38) and distortion/simulation type (No. 39 through 44).

Note that the scene sequence function does not recall an effect preset whose type is different from the current one. This is to avoid momentary audio muting, and is not a malfunction. The other mix parameters of the scene can be recalled even if it includes an effect preset whose type is different from the current one.

Recorder Functions

This chapter describes various recorder functions.

Cueing

The cueing function allows you to monitor audio at higher or lower speed.

Cueing with the [F FWD]/[REWIND] keys

By pressing the [F FWD] or [REWIND] key during playback, you can monitor (cue) the sound at 3 times the normal speed.

1 Press the [PLAY] key to start playback.

2 Press the [F FWD] or [REWIND] key during playback. The VF80EX starts "cueing" at 3 times the normal speed, while "FWD" or "RWD" appears on the screen.

The VF80EX is "cueing" in the forward direction.

```

00+ABS 0  **m**s
P01:#0001
S00:Init.Mix0
FWD >
-----
1 2 3 4 5 6 7 8 L R

```

The VF80EX is "cueing" in the backward direction.

```

00+ABS 0  **m**s
P01:#0001
S00:Init.Mix0
< RWD
-----
1 2 3 4 5 6 7 8 L R

```

3 To return to the normal playback, press the [PLAY] key.

Shuttle cueing

During playback, "shuttle cueing" is possible at the speed between 1 and 64 times the normal speed.

1 Press the [PLAY] key to start playback.

2 Rotate the [JOG/SHUTTLE] dial while holding down the [SHIFT] key.

- Rotating the [JOG/SHUTTLE] dial clockwise moves the position to the forward direction, while rotating the dial counter-clockwise moves the position to the backward direction.
- According to the rotating degree, the cueing speed varies among 1x, 2x, 4x, 8x, 16x, 32x, and 64x. The current cueing speed is shown on the screen.
- As long as holding down the [SHIFT] key, shuttle cueing continues even if you release the [JOG/SHUTTLE] dial.

The VF80EX is "cueing" in the forward direction at 64x the normal speed.

```

00+ABS 0  **m**s
P01:#0001
S00:Init.Mix0
FWD >64
-----
1 2 3 4 5 6 7 8 L R

```

The VF80EX is "cueing" in the backward direction at 64x the normal speed.

```

00+ABS 0  **m**s
P01:#0001
S00:Init.Mix0
64< RWD
-----
1 2 3 4 5 6 7 8 L R

```

The VF80EX is still.

```

00+ABS 0  **m**s
P01:#0001
S00:Init.Mix0
< STILL >
-----
1 2 3 4 5 6 7 8 L R

```

3 To return to the normal playback, press the [PLAY] key.

<Remember!>

Once the data is rewound to the beginning of a program (ABS 0), playback starts from the beginning of the program, regardless of pressing the [SHIFT] key. When reaching the end of a program (ABS: 23h 59m 59s), the program stops and the [PLAY] key flashes.

Digital scrubbing

Digital scrubbing can be done between 0x and 1x speed without changing the pitch while the VF80EX is stopped.

You can scrub audio track by track. The level envelope of the scrub track is shown on the screen, allowing you to locate the beginning of a song or interval of songs easily.

Furthermore, you can use the position located by digital scrubbing as an edit point for the track editing or auto-punch in/out.

Performing digital scrubbing

- 1 While stopped, press the [WAVE FORM SCRUB] key. The VF80EX enters the scrub mode, and the display shows the screen below.



- 2 Press the [TRACK STATUS/TRACK SEL] key for the track you are going to scrub. The level envelope of audio recorded on the selected track is shown. When the VF80 is stopped, "<STILL>" is also shown.

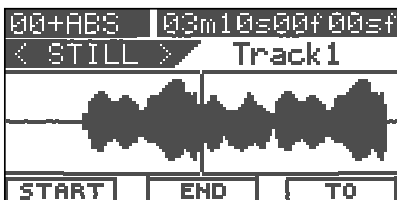

- 3 By rotating the [JOG] dial, you can scrub audio of the selected track. The vertical line in the center shows the current position, and you can hear scrubbing audio from this position to either the forward or backward direction. When rotating the [JOG] dial clockwise, "Scrub >" is shown. When rotating the [JOG] dial counter-clockwise, "<Scrub" is shown. The cursor (the vertical line) moves while scrubbing, while the time value (or bar/beat) of the current position is shown in realtime.

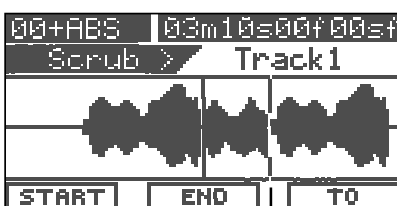

current scrubbing position

- 4 If you want to scrub another track, repeat steps 2 and 3.

Storing the digital scrub point

You can store the scrub point to the Start, End or To point for track editing functions (such as Copy, Move, Paste and Erase), or the auto-punch in point.

- **To store the scrub point to the Start point:**
Press the [SETUP/F1] key while holding down the [SHIFT] key.
"Edit Start Point Stored!" is shown briefly and then the scrub point is stored to the Start point for track editing.



- **To store the scrub point to the End point:**
Press the [TIME BASE SEL/F2] key while holding down the [SHIFT] key.
"Edit End Point Stored!" is shown briefly and then the scrub point is stored to the End point for track editing.

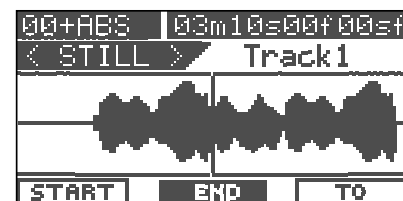

- **To store the scrub point to the To point:**
Press the [UNDO/REDO/F3] key while holding down the [SHIFT] key.
"Edit To Point Stored!" is shown briefly and then the scrub point is stored to the To point, which can be used as the starting point of Paste or the auto-punch In point.

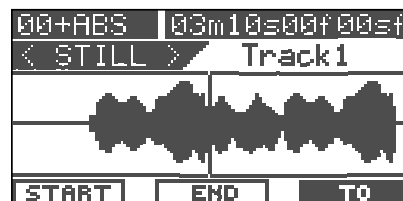

- **After storing the point, press the [EXIT/NO] key.**
The display returns to the Normal screen that was shown when finishing scrubbing.

<Hint>

- You can also store the point by pressing the [ENTER/YES] key after highlighting [START], [END] or [TO] by using the [CURSOR >] or [CURSOR <] key.
- By pressing the [MARK] key while holding down the [SHIFT] key, you can store the scrub point to a mark memory.

Vari Pitch

You can alter the playback or recording speed of the recorder within +/- 6.0 % range in 0.1 % increments/decrements by using the vari pitch function. With the vari pitch function, the pitch changes according to the speed.



Turning on or off the vari pitch function

- 1** Press the [VARI PITCH/EDIT] key.
The key lights up in green, showing the vari pitch function is active.
- 2** Press the [VARI PITCH/EDIT] key again.
The key turns off, showing the vari pitch function is not active.

<Note>

You can turn on or off the vari pitch function while stopped or during playback, however, you cannot turn on or off the function during recording.

Setting the speed

You can adjust the speed while stopped or during playback, however, you cannot adjust the speed during recording. If you adjust the speed during playback with the vari pitch function active, you can monitor the result of speed (pitch) change while adjusting.

- 1** While stopped or during playback, press the [VARI PITCH/EDIT] key while holding down the [SHIFT] key.
The current pitch value is highlighted, showing that the value can be edited.

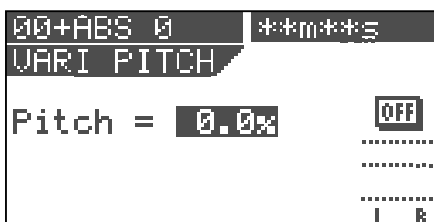

"ON" or "OFF" (of the vari pitch function) is also shown on the screen.

- 4** Use the [JOG] dial to enter the pitch value.
- 5** Press the [EXIT/NO] key to return to the Normal screen.

<Notes>

- Even if the pitch value is set to 0.0 % (no speed change), pressing the [VARI PITCH] key turns on the vari pitch function.
In such a condition, the function is active but the speed is not changed.
- The vari pitch function automatically turns off by carrying out any of the following.
 1. Turning the power off and then on. (The pitch value is also reset to 0.0 %.)
 2. Setting the slave mode to "On" in the setup mode. (The pitch value is retained.)
Note that you cannot turn on the vari pitch function when the slave mode is "On".
 3. Setting the digital input to "On" in the setup mode ("DIGI IN" is shown on the screen).
Note that you cannot turn on the vari pitch function when the digital input is selected.

Loop Function

Using the loop function, you can repeat the desired part between the Start and End points. By using the loop function together with the punch in/out or training mode, you can concentrate on playing without the need for operating the VF80EX.

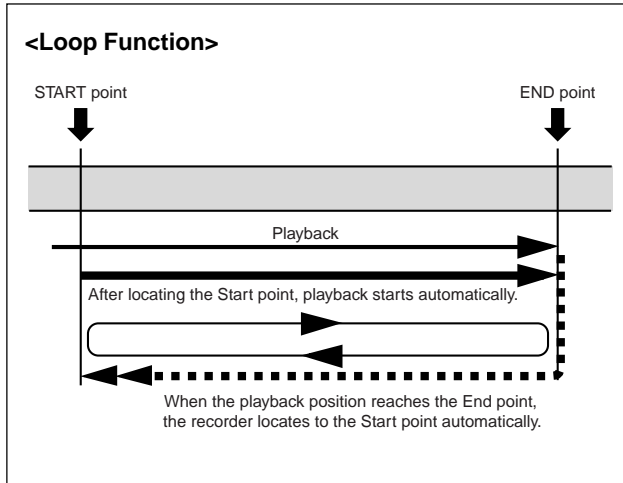

Setting the Start and End points

There are following three methods for setting the Start and End points.

1. Capturing the current position "On-the-fly"
2. Editing the time (or musical position) via the screen
3. Setting by marks

Capturing the current position "on-the-fly"

While stopped or running, you can set the Start or End point at the point you capture.

- 1 Press the [LOOP/EDIT] key while holding down the [SHIFT] key.

The display shows the loop screen in which you can set the Start and End points.

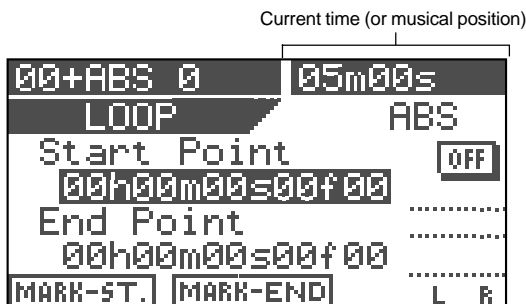

- 2 At the point where you want to set the Start point, press the [SETUP/F1] key while holding down the [SHIFT] key. "Start Point Stored!" briefly appears and the Start point is set to the captured point.

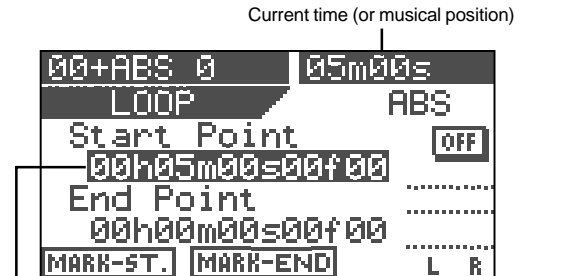

The Start point is set to the captured time (or musical position), which is shown here.

- 3 At the point where you want to set the End point, press the [TIME BASE SEL/F2] key while holding down the [SHIFT] key.

"End Point Stored!" briefly appears and the End point is set to the captured point.

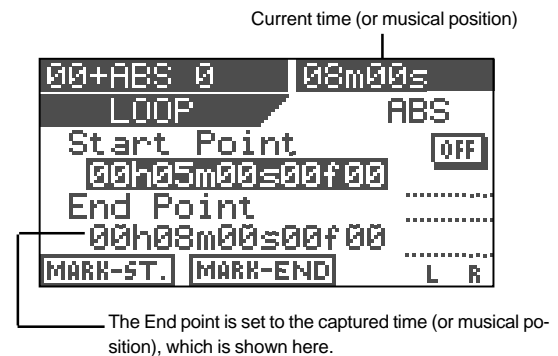

The End point is set to the captured time (or musical position), which is shown here.

<Note>

The Start point must be earlier than the End point. Otherwise, the loop function cannot be performed.

Editing the position via the screen

In the following description, the recorder is assumed to be stopped and the ABS time base is selected.

- 1 Press the [LOOP/EDIT] key while holding down the [SHIFT] key.

The display shows the loop screen in which you can set the Start and End points.

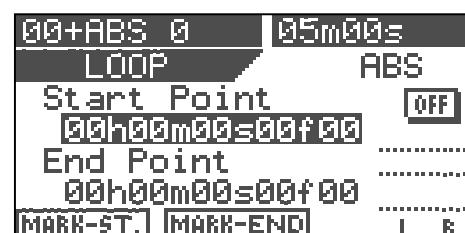

- 2** To edit the Start point, press the [ENTER/YES] key while "Start Point" value is highlighted.

The "seconds" value flashes, showing that it can be edited.

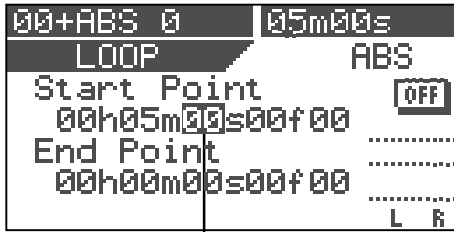

The "seconds" value flashes.

- 3** Use the [CURSOR </>] keys to move the flashing value, and use the [JOG] dial to edit the value.

You can also use the [CURSOR ▲/▼] keys to edit the value.

- 4** After editing all values, press the [ENTER/YES] key. The display returns to the similar screen shown in step 1 above, in which the Start point is set to the edited time.

- 5** To edit the End point, use the [CURSOR ▼] key to highlight the "End point" value and carry out the same operations as steps 2 through 4 above.

<Note>

As also noted in "capturing the current position on-the-fly", the Start point must be earlier than the End point. Otherwise, the loop function cannot be performed.

Setting the Start and End points by marks

You can set the Start and End points by marks.

<Note>

This method only can be used when any mark point is already stored.

- 1** While stopped, press the [LOOP/EDIT] key while holding down the [SHIFT] key.

The display shows the loop screen in which you can set the Start and End points.

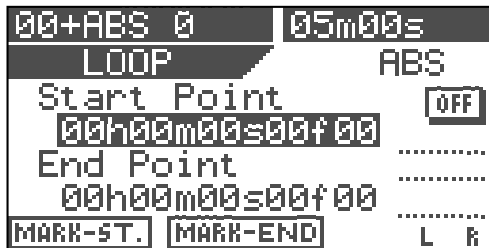

- 2** Press the [TIME BASE SEL] key. Both the Start point and End point value fields show a mark (number and name).

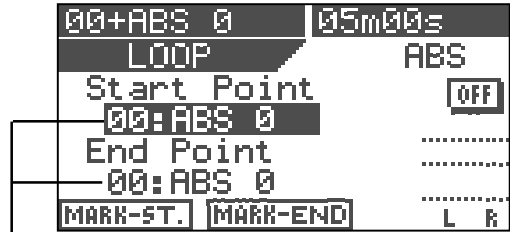

A mark is shown.

- 3** Press the [ENTER/YES] key. The mark shown on the Start point value field starts flashing.

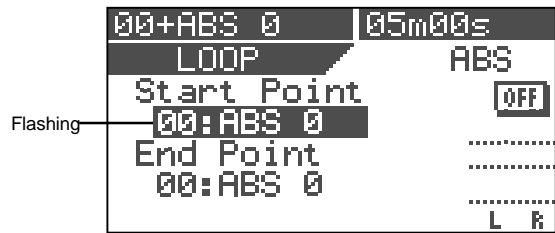

Flashing

- 4** Use the [JOG] dial to select the desired mark and press the [ENTER/YES] key.

The Start point is set to the selected mark, while the display returns to the similar screen shown in step 2 above.

- 5** To edit the End point, use the [CURSOR ▼] key to highlight the "End point" value and carry out the same operations as steps 3 through 4 above.

The selected mark is set to the End point.

<Hint>

When rehearsing the auto punch in/out, if you also activate the loop function in which the Start point is set to a point a little bit earlier than the In point while the End point is set to a point a little bit later than the Out point, you can rehearse the auto punch in/out repeatedly as many times as you like.

The loop function is also useful when you make a practice using the training mode.

Carrying out the loop playback

Once setting the Start and End points, you can carry out the loop function.

- 1** Press the [LOOP] key to illuminate the key. The loop function is now active. Each time you press the [LOOP] key, On and Off of the loop function alternates.

- 2** Start playback from the point earlier than the Start point. When the recorder reaches the End point, it automatically locates to the Start point and starts playback from that point. The recorder continues loop playback until stopping the recorder.

- 3** To stop loop playback, press the [LOOP] key to turn off the lamp and press the [STOP] key.

Program

The VF80EX can have up to 99 programs (P01 through P99) and usually each program manages one song. You can make recording against each program or playback materials recorded on each program. This section describe program-related operations.

Creating a new program

When formatting a hard disk, a program (P01) is automatically created.

To create a new program, follow the procedure below while the recorder is stopped and the display shows the Normal screen.

<Note>

The initial settings for a new program are copied from the setting of the current program.

Therefore, if you want to make a new program with the same settings as an existing program, bring up the program before creating a new program.

- 1 Press the [TRACK EDIT/PGM] key while holding down the [SHIFT] key.

The screen for selecting, renaming or deleting a program appears. (The screen example below shows the initial condition where only Program 01 exists.)



- 2 Use the [JOG] dial to highlight "P02 [New Program]" and then press the [ENTER/YES] key.

When highlighting "P02 [New Program]", only highlighted "SELECT" is shown at the bottom of the screen. Pressing the [ENTER/YES] key creates a new program (P02 in this example) with the tentative title whose leftmost character ("#" in this example) is highlighted. In this condition, you can enter the program title by following the procedure described in "<How to enter a desired title> below.

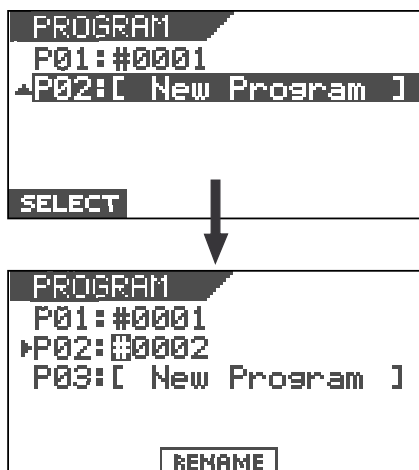

Note that you may use the program with the tentative title ("#0002" in this example) if you do not need to enter the desired one. Anyway, you may also enter/edit the title later by the procedure described in "Editing a program title" on page 62.

To use the program with the tentative title, press the [EXIT/NO] key. To put the desired title, see the following.

<How to enter a desired title>

- Rotate the [JOG] dial (or [CURSOR ▲ / ▼] keys) to select a character for the blinking point from among those listed below.
- Use the [CURSOR ◀ / ▶] keys to move the blinking point.

```

#%&'() *+,-./0123456789:;
<=>?@ABCDEFGHIJKLMN O PQRST
UVWXYZ[ \ ] ^ _ ` @ abcdefghijklm
nopqrstu vwxyz{|}~+_-!"
  
```

<Hint>

When selecting a character, rotating the [JOG] dial while holding down the [SHIFT] key jumps among characters surrounded with the box above. This function will allow you to save time for selecting a desired character.

- 3 Press the [ENTER/YES] key after entering the title. The title is set.

- 4 Press the [EXIT/NO] (or [STOP]) key. The setup mode exits and the display shows the Normal screen of the newly created program.

<Hint>

- When creating a new program, the next program number to the highest program number in the existing programs is assigned. If there is only one program (P01), Program 02 (P02) will be created. If there is five programs (P01 through P05), Program 06 (P06) will be created.
- Creating a new program consumes a small amount of the recordable disk space. Also note that when the recordable disk space is not enough, you cannot create a new program.

Selecting a program

When more than one program exists on the disk, you have to select the desired program before starting operations for recording, playback or editing. Select the desired program by following the procedure below while the recorder is stopped and the display shows the Normal screen.

- 1 Press the [TRACK EDIT/PGM] key while holding down the [SHIFT] key.

The screen for selecting, renaming or deleting a program appears. In the screen, all existing program numbers and titles are shown.

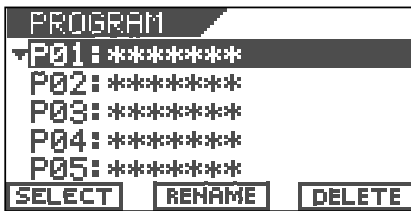

- 2 Use the [JOG] dial to highlight the desired program and then press the [SETUP/F1] key while holding down the [SHIFT] key.

- 1 Press the [TRACK EDIT/PGM] key while holding down the [SHIFT] key.

The screen for selecting, renaming or deleting a program appears. In the screen, all existing program numbers and titles are shown.

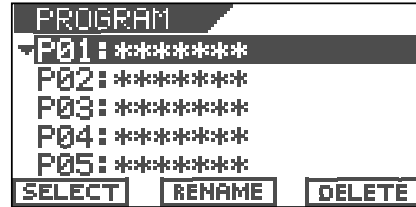

- 2 Use the [JOG] dial to highlight the program to be deleted and then press the [UNDO/REDO/F3] key while holding down the [SHIFT] key.

The screen shows "Delete! Sure?", asking you confirm.

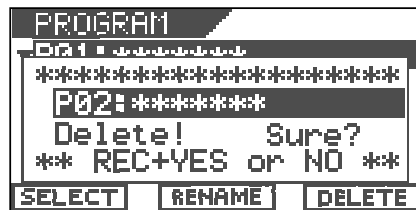

<Hint>

You may use the [CURSOR] to highlight "DELETE" and press the [ENTER/YES] key to bring up the screen above, instead of pressing the [UNDO/REDO/F3] key while holding down the [SHIFT] key.

Deleting a program

You can delete an unnecessary program individually. To make recording or editing, a certain amount of disk space is needed. By deleting unnecessary programs, the available disk space increases.

<Notes>

- When only one program (P01) exists, if you try to delete the program, the data in the program is deleted but P01 remains.
- For example, when five programs (P01 through P05) exist, if you delete P03, it looks like P05 is deleted. This is because the program numbers higher than 03 move down. In other words, P04 and P05 become P03 and P04 respectively.

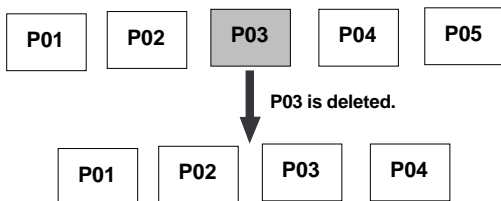

Note that you cannot undo or redo deleting the program.

- 3 Press the [ENTER/YES] key while holding down the [RECORD] key.

The selected (highlighted) program is deleted, and the following programs in the list move up.

- 4 Press the [EXIT/NO] key to switch to the Normal screen.

The previous program of the deleted program is selected.

Editing a program title

You can edit a program title anytime by following the procedure below.

Note that you can also enter a program title in the process of creating a new program as mentioned earlier.

- 1 Press the [TRACK EDIT/PGM] key while holding down the [SHIFT] key.

The screen for selecting, renaming or deleting a program appears. In the screen, all existing program numbers and titles are shown.



- Use the [JOG] dial to highlight (select) the desired program and then press the [TIME BASE SEL/F2] key while holding down the [SHIFT] key.

Now you can edit the title of the selected program. The leftmost character of the selected program is flashing.

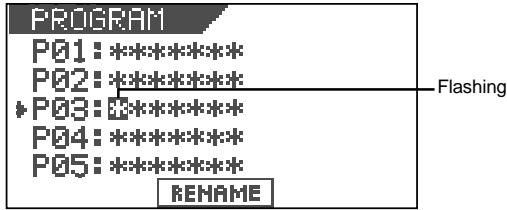

<Hint>

You may use the [CURSOR ▶] to highlight "RENAME" and press the [ENTER/YES] key to bring up the screen above, instead of pressing the [TIME BASE SEL/F2] key while holding down the [SHIFT] key.

- Use the [CURSOR ◀/▶] keys to move the flashing (editing) point and use the [JOG] dial (or [CURSOR ▲/▼] keys) to select a character for the flashing point.

You can put a title name with up to 16 characters from among those listed below.

When selecting a character, rotating the [JOG] dial while holding down the [SHIFT] key jumps among characters surrounded with the box below.

```

# $ % & ' ( ) * + , - . / 0 1 2 3 4 5 6 7 8 9 : ;
< = > ? @ [ A B C D E F G H I J K L M N O P [ Q R S T
U V W X Y Z [ \ ] ^ _ ` @ a b c d e f g h i j k l m
n o p [ q r s t u v w x y z ( ) * + , - . / ! "
    
```

- Press the [ENTER/YES] key after editing/entering the title. The edited/entered title is set.
- Press the [EXIT/NO] (or [STOP]) key. The display returns to the Normal screen.

Track editing

Because the VF80EX uses a 3.5-inch E-IDE hard disk as the recording media, you can make non-linear and non-destructive audio editing by track effectively.

Copy & Paste

The Copy & Paste function allows you to copy track data of a desired part and paste it to a desired part of the same or different track.

The copied data remains after pasting the data, so you can paste the data as many times as required.

The copy & paste function is useful when using the same musical part repeatedly in a song.

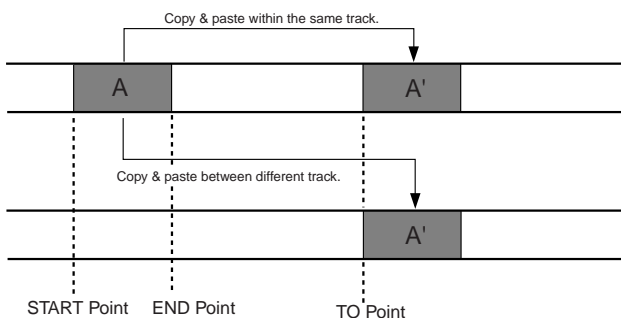

Move & Paste

The Move & Paste function allows you to move track data of a desired part and paste it to a desired part of the same or different track.

Unlike the copy & paste operation, the moved data does not remain in the original position.

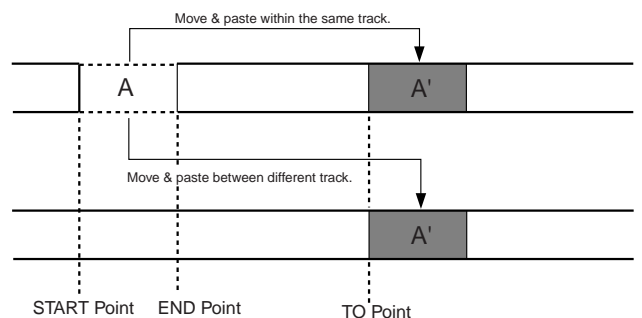

<Notes>

- Copy data (or Move data) is replaced with the new data every time the copy (or move) operation is carried out.
- Note that copy data changes if you paste the copy data to the original data.
- The copy & paste (or move & paste) editing is performed on the current program. Therefore, do not change the current program until the editing operations are completed.

Performing Copy (or Move) & Paste

- 1 Set the Start and End points for the copy (or move) operation and To point for the paste operation.**

Using the digital scrub function, set the Start, End and To points. See "Storing the digital scrub point" for details about how to set the points.

- 2 While the recorder is stopped, press the [TRACK EDIT] key.**

The screen for selecting the track edit type appears.

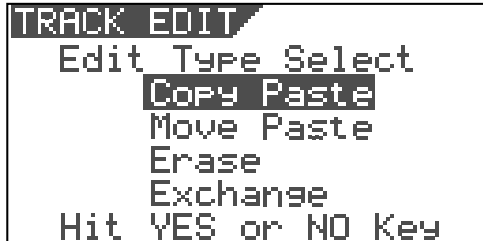

- 3 Use the [JOG] dial to select "Copy Paste" (or "Move Paste") and then press the [ENTER/YES] key.**

The display shows the screen for selecting the source track(s) and destination track(s).

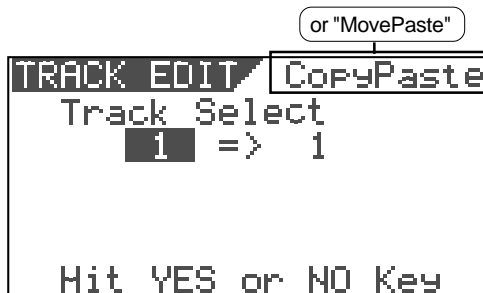

- 4 Use the [JOG] dial to select the source track(s) from which the data is copied (moved).**

Rotating the [JOG] dial changes the options among 1 through 8, 1&2, 3&4, 5&6, 7&8, 1-6, and 1-8.

- 5 Use the [CURSOR >] key to highlight (and flashes) the right field, and use the [JOG] dial to select the destination track(s) to which the data is copied (moved).**

Rotating the [JOG] dial changes the options as below depending on the track(s) you selected in step 4.

Source track(s)	Destination options
a mono track (1 through 8)	1 through 8
a pair of tracks	1&2, 3&4, 5&6, and 7&8
1-6	1-6 only
1-8	1-8 only

In the example below, data on tracks 3&4 is copied (or moved) and pasted onto tracks 7&8.

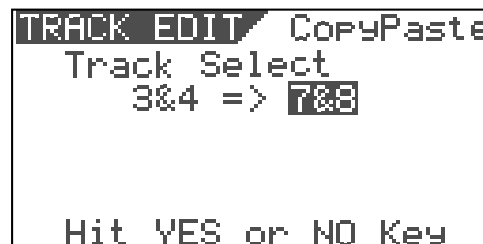

The corresponding [TRACK STATUS/TRACK SEL] keys of the source track(s) light in green, while the corresponding [TRACK STATUS/TRACK SEL] keys of the destination track(s) light in red.

- 6 Press the [ENTER/YES] key after selecting tracks.**

The display shows the "Point Select" screen as below, in which you can view the Start, End and To points set via the digital scrub operation.



<Hints>

On the screen above, you can perform the following operations.

- 1. Editing the Start, End and To points**
- 2. Setting the Start and To points to "ABS 0" and the End point to "REC END"**
- 3. Checking the data to be copied (or moved)**
- 4. Setting the Start, End and To points by marks**

• To edit the Start, End and To points:

Highlight the time field of the desired (Start, End or To) point, and then press the [ENTER/YES] key.

The "seconds" value starts flashing, showing that you can edit it. Use the [CURSOR </>] keys to move the flashing value, and use the [JOG] dial to enter a value.

After entering the desired time, pressing the [ENTER/YES] key to store the time data to the point.

• To set the Start and To points to "ABS 0" and the End point to "REC END":

Press the [SETUP/F1] key while holding down the [SHIFT] key. "ALL OFF" changes to "ALL ON", and the Start and To points are set to "ABS 0", while the End point is set to "REC END" point. This function is useful when you copy (or move) all track data (from "ABS 0" to "REC END") to different track(s).

• To check (monitor) the data to be copied (or moved)

[Source Play function]:

Press the [TIME BASE SEL/F2] key while holding down the [SHIFT] key.

The display shows the "Source Play" screen as shown below and the recorder starts playback of the data to be copied (or moved).



You can hear audio by moving up the corresponding track fader. After checking audio, press the [STOP] key. The display returns to the screen shown before performing the Source play function.

• To set editing points by marks:

Press the [TIME BASE SEL] key.

Each data field for the Start, End and To points changes to show the current option by mark as shown below.

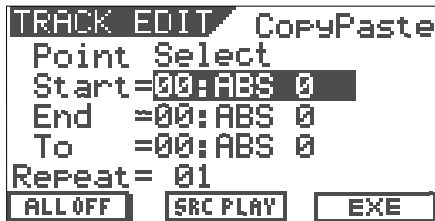

Use the [CURSOR ▲/▼] keys to highlight the field for the desired point, and press the [ENTER/YES] key. The field starts flashing.
Use the [JOG] dial to select the desired mark and press the [ENTER/YES] key.
The point is set to the selected mark.

<Note>

This operation can be performed only when any mark is set. When no mark is set, "00:ABS 0" is the one and only option for each point.

6 Use the [CURSOR ▼] key to highlight the field ("01" above) for the number of times for repeat paste, and press the [ENTER/YES] key.

"01" starts flashing and you can now enter the number of times for repeat paste.



7 Use the [JOG] dial to select the desired number and press the [ENTER/YES] key.

You can select any number between "01" and "99".

<Note>

Basically you can select the number of times for repeat paste between 1 and 99, however, if the recordable space of the hard disk is limited, you may not be able to select the desired number. The VF80EX automatically calculate the available space and limit the number of times to the appropriate value.

When setting the number of times for repeat paste to 02, the copy & paste function is performed as below.

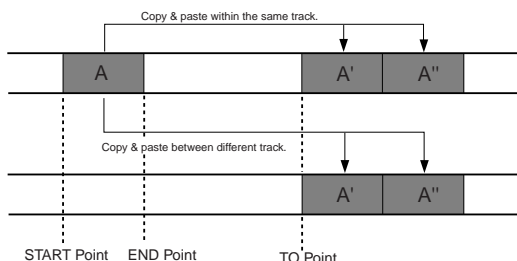

8 Press the [UNDO/REDO/F3] key while holding down the [SHIFT] key.

The copy & paste (or move & paste) function is performed. When finished, "Completed!" appears on the screen.

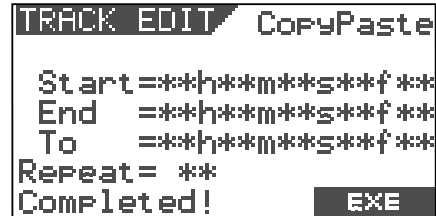

<Hint>

You may use the [CURSOR ▶] to highlight "EXE" and press the [ENTER/YES] key to perform the function, instead of pressing the [UNDO/REDO/F3] key while holding down the [SHIFT] key.

<Note>

The copy & paste (or move & paste) operation cannot be performed when there is not enough disk space to perform the undo and redo operations. If you try to perform the paste operation when there is not enough disk space, The display will show "Over Time!", as well as the short time.

In such a case, shorten the copy (or move) data by the amount more than the displayed time or delete unnecessary sections or programs to keep the enough space, and then try to paste again.

Undo/redo of Copy & Paste

You can undo a copy & paste or move & paste operation, as well as redo it (undo the undo operation).

- By pressing the [UNDO/REDO] key after completing the copy & paste (or move & paste) operation, you can return the track(s) to the condition before performing the copy & paste (or move & paste) operation.
- By pressing the [UNDO/REDO] key just after performing the undo operation, you can undo the undo operation and return the track(s) to the condition after performing the copy & paste (or move & paste) operation.

Note the following for performing the undo/redo operation.

<Notes>

You can undo or redo only when the recorder is stopped. If you carry out any of the following after performing the copy & paste (or move & paste) operation, you cannot undo/redo the copy & paste (or move & paste) operation.

1. Making a new recording
2. Performing a new editing
3. Letting the recorder run in playback (or recording) mode and pass through the auto punch-in point while the auto punch mode is active
4. Turning off the power of the VF80EX
5. Performing any of the program operations (select, rename or delete).

Erasing track data

You can erase a desired part of track data. You can select a track or tracks (of which you are going to erase data) from among each individual track, each pair of tracks, 1-6 and 1-8.

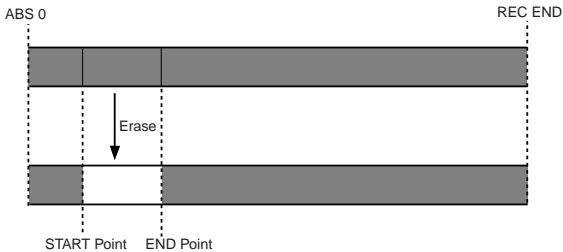

<Notes for the erase function>

- When all eight tracks (1 through 8) are recorded, if you erase a part of the chosen track, only the erased part becomes silent (no audio) and the following material does not move advance to fill the gap. Therefore, the REC END point remains the same. However, if you erase a part between the chosen point (=Start point) and the REC END point (=End point) of all tracks, the REC END point moves advance.
- The erase operations are performed on the current program. Therefore, do not change the current program until all the operations are completed.

Erasing

1 Set the Start and End points for the erase operation.

Using the digital scrub function, set the Start and End points. See "Storing the digital scrub point" for details about how to set the points.

2 While the recorder is stopped, press the [TRACK EDIT] key.

The screen for selecting the track edit type appears.



3 Use the [JOG] dial to select "Erase" and then press the [ENTER/YES] key.

The display shows the screen for selecting the track(s) to be erased.

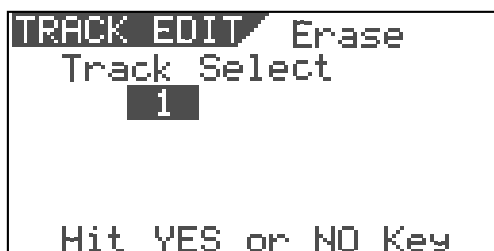

4 Use the [JOG] dial to select the track(s) to be erased.

Rotating the [JOG] dial changes the options among 1 through 8, 1&2, 3&4, 5&6, 7&8, 1-6, and 1-8. The corresponding [TRACK STATUS/TRACK SEL] key(s) of the selected track(s) light in red.

5 Press the [ENTER/YES] key after selecting the track(s).

The screen shows the Start and End points.



<Hint>

On the screen above, you can perform the following operations.

1. Editing the Start and End points
2. Setting the Start point to "ABS 0" and the End point to "REC END"
3. Checking the data to be erased
4. Setting the Start and End points by marks

•To edit the Start and End points:

Highlight the time field of a desired (Start or End) point, and then press the [ENTER/YES] key.

The "seconds" value starts flashing, showing that you can edit it. Use the [CURSOR </>] keys to move the flashing value, and use the [JOG] dial to enter a value.

After entering the desired time, pressing the [ENTER/YES] key to store the time data to the point.

•To set the Start point to "ABS 0" and the End point to "REC END":

Press the [SETUP/F1] key while holding down the [SHIFT] key. "ALL OFF" changes to "ALL ON", and the Start point is set to "ABS 0", while the End point is set to "REC END" point. This function is useful when you erase all track data.

•To check (monitor) the data to be erased [Source Play function]:

Press the [TIME BASE SEL/F2] key while holding down the [SHIFT] key.

The display shows the "Source Play" screen as shown below and the recorder starts playback of the data to be erased.

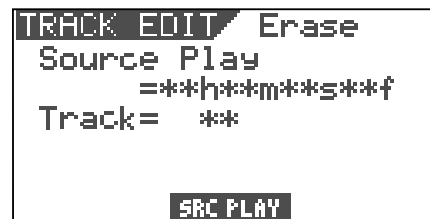

You can hear audio by moving up the corresponding track fader. After checking audio, press the [STOP] key. The display returns to the screen shown before performing the Source play function.

• **To set editing points by marks:**

Press the [TIME BASE SEL] key.

Each data field for the Start and End points changes to show the current option by mark as shown below.

```

TRACK EDIT Erase
Point Select
Start=00:ABS 0
End =00:ABS 0
ALL OFF SRC PLAY EXE

```

Use the [CURSOR ▲/▼] keys to highlight the field for the desired point, and press the [ENTER/YES] key. The field starts flashing.

Use the [JOG] dial to select the desired mark and press the [ENTER/YES] key.

The editing point is set to the selected mark.

<Note>

This operation can be performed only when any mark is set. When no mark is set, "00:ABS 0" is the one and only option for each point.

6 Press the [UNDO/REDO/F3] key while holding down the [SHIFT] key.

The erase function is performed. When finished, "Completed!" appears on the screen.

```

TRACK EDIT Erase
Start=**h**m**s**f**
End =**h**m**s**f**
Completed! EXE

```

<Hint>

You may use the [CURSOR ►] to highlight "EXE" and press the [ENTER/YES] key to perform the function, instead of pressing the [UNDO/REDO/F3] key while holding down the [SHIFT] key.

Undo/redo of Erase

You can undo an erase operation, as well as redo it (undo the undo operation).

- By pressing the [UNDO/REDO] key after completing the erase operation, you can return the track(s) to the condition before performing the erase operation.
- By pressing the [UNDO/REDO] key just after performing the undo operation, you can undo the undo operation and return the track(s) to the condition after performing the erase operation.

Note the following for performing the undo/redo operation.

<Notes>

You can undo or redo only when the recorder is stopped. If you carry out any of the following after performing the erase operation, you cannot undo/redo the erase operation.

1. Making a new recording
2. Performing a new editing
3. Letting the recorder run in playback (or recording) mode and pass through the auto punch-in point while the auto punch mode is active
4. Turning off the power of the VF80EX
5. Performing any of the program operations (select, rename or delete).

Track Exchange

The track exchange function allows you to exchange tracks (regardless of whether they are real or additional tracks) on the program in single track unit, 2-track unit or 8-track unit.

By using this function, you can exchange tracks not only among real tracks but also between real and additional tracks, allowing to use tracks effectively. For example, by exchanging a recorded real track with an empty additional track, you can transfer data on a real track to an additional track temporarily, so that you can record a new material onto the real track. The track exchange function is also used to check the REC END point on an additional track.

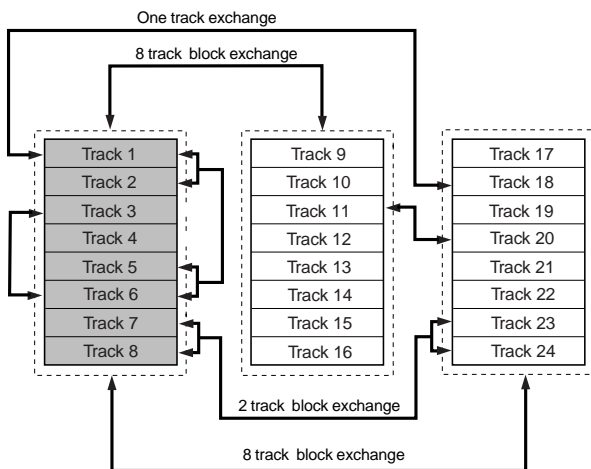

Performing the track exchange

- 1 While the recorder is stopped, press the [TRACK EDIT] key.

The screen for selecting the track edit type appears.

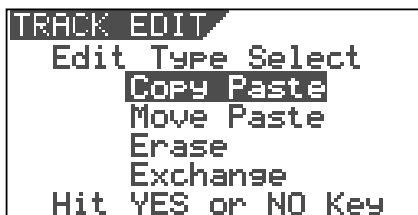

- 2 Use the [JOG] dial to select "Exchange" and then press the [ENTER/YES] key.

The display shows the screen for selecting the tracks to be exchanged. The screen example below shows that tracks 01 through 08 and tracks 17 through 24 are exchanged in 8-track unit.

The left field shows the source track(s), while the right fields shows the destination track(s).

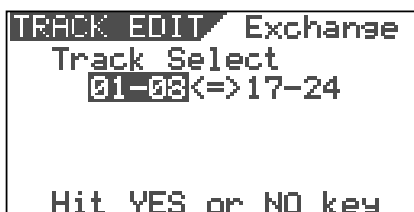

- 3 Use the [JOG] dial to select the source track(s). Rotating the [JOG] dial changes the options among single tracks (1 through 24), pair tracks (1&2 through 23&24), 1-8, 9-16 and 17-24.

- 4 Use the [CURSOR >] key to highlight (and flashes) the right field, and use the [JOG] dial to select the destination track(s).

You can only select the same number of tracks as the source track(s) selected in step 3 above.

For example, if you select a single track in step 3 above, you can only select a single track here.

<Example 1> Exchanging Track 8 and Track 24

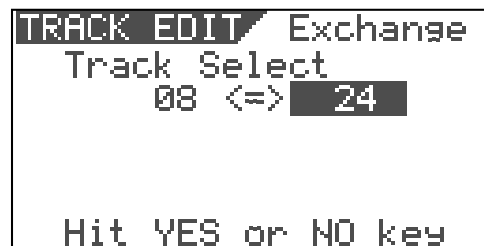

<Example 2> Exchanging Tracks 1&2 and Tracks 7&8

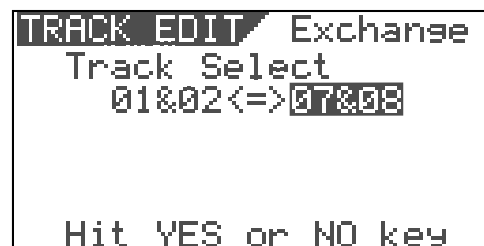

<Example 3> Exchanging Tracks 1-8 and Tracks 17-24

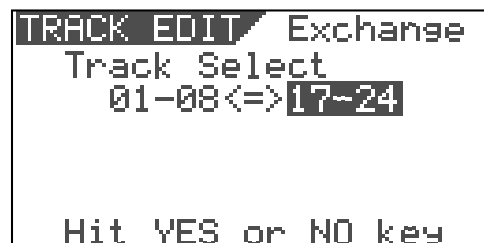

- 5 After selecting tracks, press the [ENTER/YES] key. The track exchange function is performed and the display returns to the Normal screen.

<Note for Track Exchange>

If the selected tracks for the left and right fields are reversed, the same track exchange is performed.

For example, "1-8<->17-24" and "17-24<->1-8" perform the same track exchange.

The setting in which the same track(s) are selected for both the left and right fields, such as "1-8<->1-8", is invalid.

If you press the [ENTER/YES] key with such a setting, the display shows the message "Select Err! Hit Any Keys".

Editing Marks

This section describes how to edit marks, assuming that more than one mark is already stored in realtime according to the operations described in "Basic Recording and Playback".

Viewing the mark list

You can view the marks stored.

- 1 While the recorder is stopped, press the [SCENE SEQ./MAP] key while holding down the [SHIFT] key.

The mark positions are shown by time or bar/beat/clock values depending on the time base (In the following screen example, the time base is set to "Bar/Beat/Clk").

MARK MAP	BAR/	BEAT/	CLK
00:-02BAR	1/00		S00
01:012BAR	1/00		Non
02:020BAR	4/30		Non
*03:028BAR	6/46		Non
04:022BAR	2/30		Non
LOCATE	EDIT	DELETE	

- 2 Use the [JOG] dial or [CURSOR ▲ / ▼] keys to scroll the marks stored.

In the Mark map screen, you can not only view all the marks but also perform various operations (such as editing a mark position, entering a mark title, locating a mark, deleting a mark and adding a mark) described later.

<Hint>

When the Mark map screen is shown, you can switch the screen to display the position (by time or bar/beat/clock) or title of each mark by pressing the [TIME BASE SEL] key.

- 3 After viewing the list, press the [EXIT/NO] key. The display returns to the Normal screen.

Editing a mark position

You can edit the current position of a mark in the mark map.

- 1 While the recorder is stopped, press the [SCENE SEQ./MAP] key while holding down the [SHIFT] key.

The Mark map screen appears.

MARK MAP	BAR/	BEAT/	CLK
00:-02BAR	1/00		S00
01:012BAR	1/00		Non
02:020BAR	4/30		Non
*03:028BAR	6/46		Non
04:022BAR	2/30		Non
LOCATE	EDIT	DELETE	

- 2 Use the [JOG] dial or [CURSOR ▲ / ▼] keys to highlight the desired mark, and then press the [TIME BASE SEL/F2] key.

The display shows the screen for editing the chosen mark.

MARK MAP	MARK03	Edit
Blinking	028BAR	6/46CLK
	Name =	ABS 0
	Scene =	Non
Hit ENTER or EXIT		

- 3 Use the [CURSOR ◀/▶] keys to highlight (and flashes) the field you want to edit, and then use the [JOG] dial to select the desired value.

When the time base is set to "ABS" or "MTC", you can edit fields for minute, second, frame and subframe. When the time base is set to "Bar/Beat/Clk", you can edit fields for bar, beat and clock, as shown below.

MARK MAP	MARK03	Edit
	028BAR	6/46CLK

- 4 After editing time (or bar/beat/clock), press the [ENTER/YES] key.

The edited value is stored to the mark and the display returns to the Mark map screen.

- 5 Press the [EXIT/NO] key.

The display returns to the Normal screen.

Enter a mark title

You can enter or edit a title for each mark.

- 1 While the recorder is stopped, press the [SCENE SEQ./MAP] key while holding down the [SHIFT] key. The Mark map screen appears.



- 2 Use the [JOG] dial or [CURSOR ▲ / ▼] keys to highlight the desired mark, and then press the [TIME BASE SEL/F2] key.

The display shows the screen for editing the chosen mark.

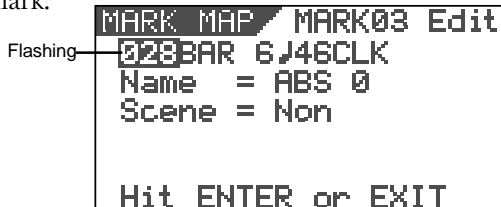

- 3 Press the [CURSOR ◀/▶] keys repeatedly to highlight (and flashes) the leftmost point of the title field.

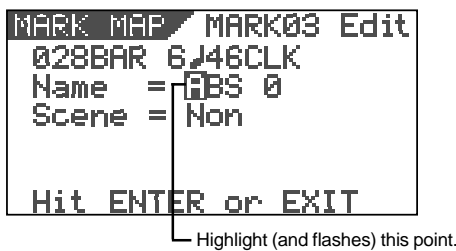

- 4 Use the [CURSOR ◀/▶] keys to move the highlighted point among the title field, and use the [JOG] dial to select the desired character.

You can use up to 14 characters for each title but because of the screen size, characters displayed at once are limited. You can select a character from among the following.

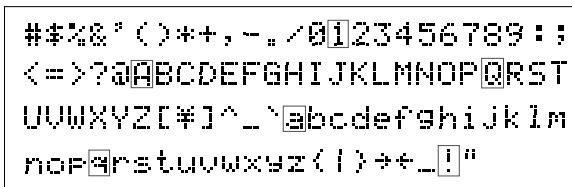

Hint

When selecting a character, rotating the [JOG] dial while holding down the [SHIFT] key jumps among characters surrounded with the box above.

- 5 After entering/editing the title, press the [ENTER/YES] key.

The entered/edited title is stored to the mark.

- 6 Press the [EXIT/NO] key.

The display returns to the Normal screen.

Adding a mark

You can add a mark to the mark map.

- 1 While the recorder is stopped, press the [SCENE SEQ./MAP] key while holding down the [SHIFT] key. The Mark map screen appears.

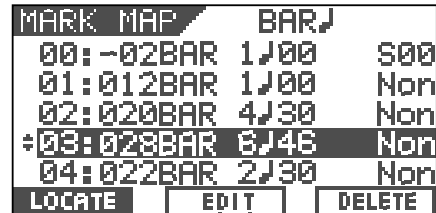

- 2 Use the [JOG] dial or [CURSOR ▲ / ▼] keys to highlight "New Mark", and then press the [TIME BASE SEL/F2] key.

You can find "New Mark" at the bottom of the mark map.

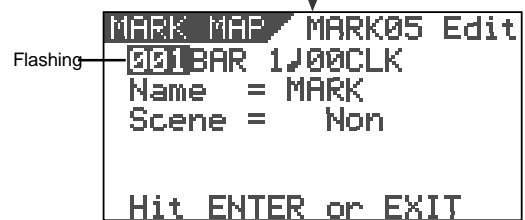

On the screen for editing the mark, "001" (Bar number field) is flashing, showing that it can be edited.

The mark name is tentatively set to "Mark", while no scene is assigned (indicated by "Non").

- 3 Use the [CURSOR ◀/▶] keys to highlight (and flashes) the field you want to edit among BAR, BEAT and CLK, and then use the [JOG] dial to select the desired value.

When setting the time base to ABS or MTC, you can set the position in the similar way.

- 4 After setting the mark position, press the [ENTER/YES] key.

The new mark is added to the mark map and the display returns to the Mark map screen.

- 5 Press the [EXIT/NO] key.

The display returns to the Normal screen.

<Hint>

When adding a new mark, you can also enter a mark title or assign a scene for the scene sequence function. See "Enter a mark title" above and "Scene Memory" in "Mixer Functions" for details about operations.

Deleting a mark

You can delete an unnecessary mark.

- 1 While the recorder is stopped, press the [SCENE SEQ./MAP] key while holding down the [SHIFT] key. The Mark map screen appears.

MARK	MAP	BAR	TIME	STATUS
00	-02	BAR	1/00	S00
01	01	BAR	1/00	Non
02	02	BAR	4/30	Non
03	02	BAR	6/46	Non
04	02	BAR	2/30	Non

LOCATE EDIT DELETE

- 2 Use the [JOG] dial or [CURSOR ▲ / ▼] keys to highlight the mark you want to delete, and then press the [UNDO/REDO/F3] key while holding down the [SHIFT] key.

"Delete!" is shown and "Sure?" flashes.

To cancel the delete operation, press the [EXIT/NO] key.

MARK	MAP	BAR	TIME	STATUS
00	-02	BAR	1/00	S00

03	02	BAR	6/46	Non
Delete! Sure? Flashing				
** REC+YES or NO **				

LOCATE EDIT DELETE

- 3 Press the [ENTER/YES] key while holding down the [RECORD] key.

The chosen mark is deleted and the mark map is sorted, resulting marks following the deleted mark in the mark map list move up.

For example, if you delete Mark 03, the current Mark 04, 05,... will replace Mark 03, 04,... respectively.

- 4 Press the [EXIT/NO] key. The display returns to the Normal screen.

Locating a mark

You can directly locate to a mark.

- 1 While the recorder is stopped, press the [SCENE SEQ./MAP] key while holding down the [SHIFT] key. The Mark map screen appears.

MARK	MAP	BAR	TIME	STATUS
00	-02	BAR	1/00	S00
01	01	BAR	1/00	Non
02	02	BAR	4/30	Non
03	02	BAR	6/46	Non
04	02	BAR	2/30	Non

LOCATE EDIT DELETE

- 2 Use the [JOG] dial or [CURSOR ▲ / ▼] keys to highlight the mark you want to locate to, and then press the [SETUP/F1] key while holding down the [SHIFT] key.

The recorder locates to the selected mark, and the display returns to the Normal screen.

<Hint>

If you press the [SETUP/F1] key while holding down the [SHIFT] key after editing a mark position (see "Editing a mark position"), you can locate to the new mark position.

Advanced Operations

This chapter describes advanced or useful functions of the VF80EX.

Metronome function

The VF80EX provides the internal tempo map, in which you can set the time signature (e.g. 4/4, 3/4) and tempo (between 30 and 250).

It also can output the metronome sound (click) according to the tempo map, allowing you to record materials at the specific tempo without the need of an external metronome or rhythm machine.

The metronome sound can be output from Track 6 of the VF80 when you set "Click?" in the Setup menu to "On."

<Note>

When Track 6 is set to output the metronome sound (i.e. when you set "Click?" menu in the Setup menu to "On"), you cannot record audio on Track 6 or playback audio recorded on Track 6.

When you have finished using the metronome function, we recommend setting "Click?" menu in the Setup mode to "Off" so that you can use Track 6 for recording and playback.

Setting the tempo map

To output the metronome sound (click), the tempo map must be set.

To set the tempo map, use "Signature Set" and "Tempo Set" menus in the Setup mode.

Initially, the time signature is set to "4/4" while the tempo is set to "120."

To change the initial settings, operate the following.

- 1** While the VF80EX is stopped, press the [SETUP] key to enter the Setup mode.
The screen for selecting a menu in the Setup mode appears.
- 2** Use the [JOG] dial to select the "Signature Set" menu, and then press the [ENTER/YES] key.
The screen for setting the time signature appears.
Set the desired time signature according to the procedure described in "Setting the time signature" on page 134.
- 3** After setting the time signature, press the [EXIT/NO] key to return to the screen for selecting a menu in the Setup mode.
- 4** Use the [JOG] dial to select the "Tempo Set" menu, and then press the [ENTER/YES] key.
The screen for setting the tempo appears.
Set the desired tempo according to the procedure described in "Setting the tempo" on page 136.
- 5** After setting the tempo, press the [EXIT/NO] key to return to the screen for selecting a menu in the Setup mode.
Go on to set the metronome output described below.

Setting the metronome output

You can set whether outputting the metronome sound or not by "Click?" menu in the Setup mode.

- 1** Use the [JOG] dial to select the "Click?" menu, and then press the [ENTER/YES] key.
The initial setting is "Off."
- 2** Use the [JOG] dial to select "On", and then press the [ENTER/YES] key.
Now the metronome sound will be output from Track 6.
- 3** Press the [EXIT/NO] key repeatedly until exiting the Setup mode.

Setting the time base to bar/beat

- 1** Press the [TIME BASE SEL] key to set the time base to "Bar/Beat."
When the time base is set to "Bar/Beat", you can monitor the current position by Bar/Beat according to the tempo map you set.

Monitoring the metronome sound

- 1** Press the [PLAY] key to start playback of the VF80EX.
The level meter for Track 6 shows the metronome sound level.
Set the Master and Track 6 faders to the "0" position, and raise the [PHONES] knob to monitor the metronome sound via the headphones.

You can now record a material while listening to the metronome sound as a guide.

Track bounce (Ping-pong recording)

When the number of empty tracks is short in the recording process, you can solve the problem by transferring audio on the multiple already-recorded tracks to a different track or tracks.

This operation is called "Track bounce" or "Ping-pong recording". With the VF80EX, you can do this operation simply by using the [BOUNCE] key.

When the Bounce mode is active, Tracks 7/8 are automatically armed and the materials recorded on Tracks 1 through 6 are ready to be bounced to Tracks 7/8.

In the following description for track bouncing operation, we assume that mono materials are recorded on Tracks 1 through 4, while a stereo material is recorded on Tracks 5 and 6.

On/Off of bounce mode

1 Press the [BOUNCE] key.

Each press of the key alternates "On" and "Off."

When set to "On", the key is illuminated, while the Bounce screen appears where "Remain" is displayed.



Tracks 7/8 are automatically armed and the corresponding [TRACK STATUS/TRACK SEL] key flashes in red. When the Bounce mode is active, you cannot arm the other tracks (1 through 6).

<Note>

If the peak indicator lights up, the recorded sound will be distorted. Adjust the playback level of each track appropriately.

You can see the playback levels on Tracks 1 through 6, input levels on Track 7/8 and output levels of the Stereo busses (L and R) via the meters on the screen.

By raising the [PHONES] knob, you can monitor the sound.



4 After adjusting the levels, stop the recorder and then locate to the beginning position of track bouncing.

Setting pan positions

1 Press the [PAN] key to set the pan position for each track.

Set the pan positions at the desired points for Tracks 1 through 4, fully left for Track 5 and fully right for Track 6. See "Mixer Functions" for details about the pan setting.

2 After setting all pan positions, press the [EXIT/NO] key. The balance mode screen appears.

Performing the track bounce

1 Press the [PLAY] key while holding down the [RECORD] key to start track bouncing.

The recorder starts recording of mixed audio from Tracks 1 through 6 to Tracks 7/8.

2 After finishing the track bounce, press the [STOP] key to stop the recorder.

Now you can use Tracks 1 through 6 to record new materials.

Setting level of each track

1 Set the [MASTER] fader to the "0" position.

2 Press the [RECORD] key only.

The [RECORD] key starts flashing, while Tracks 7/8 enter the input monitor mode.

3 Press the [PLAY] key to start playback and adjust playback levels of Tracks 1 through 6 using the track faders.

Be careful not to light up the peak indicator when adjusting the playback level of each track.

<Notes>

- You can also apply EQ and/or effects to audio signals on Tracks 1 through 6 to be bounce to Track 7/8. See "Mixer Function" for details about how to apply EQ and effects.
- When the Bounce mode is active, you can use any of effect types L01 through L38. Note that, if you enter the Bounce mode when any of insert effect types is selected, "L01: Norm HALL" will be automatically selected.

Training mode

The VF80EX provides the training mode which allows you to practice your instrument while playing back only Tracks 7/8. In the training mode, you can slow down the playback speed or altering the pitch, making it easy to play along with your favorite musicians or transcribing ad-lib phrases.

You can also cancel the vocal or lead guitar solo which is positioned in the center, allowing you to replace it with your vocal or guitar (like a karaoke).

The following description shows how to play the guitar along with audio recorded on Tracks 7/8.

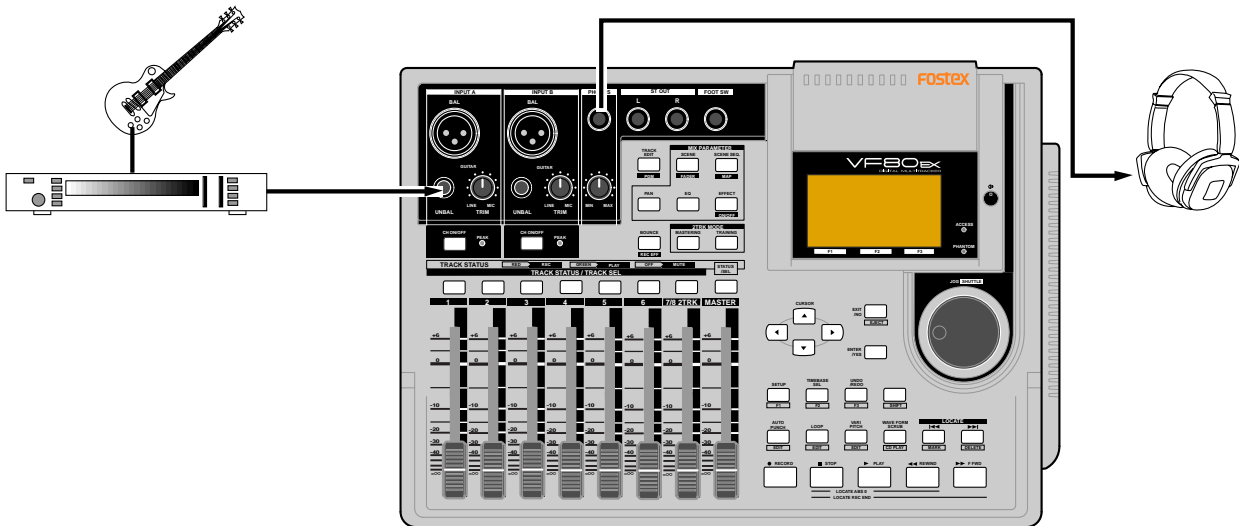

<Hint>

Because only Tracks 7/8 can be played back in the Training mode, you have to record a song used for your practice in advance.

If you are going to use a song recorded on other tracks, it will be a good idea to use the track exchange function to move the song to Tracks 7/8.

Also, when you want to use an external source on CD, MD, etc., record it onto Tracks 7/8 digitally using the technique described later in "Digital Recording."

<Caution>

When copying a copyright material from CD, MD, etc., do not use the copy for any purpose except your practice or enjoyment. Any unauthorized use of the copy for commercial purpose will constitute infringement of such copyright and will render the infringer liable to an action at law.

<Note>

When the training mode is active, you cannot make any recording, as well as playback Tracks 1 through 6.

Connecting the instrument and headphones

- 1 Set the [MASTER] fader to the "∞" position.
- 2 Connect the instrument and headphones as shown in the illustration above.
You may connect the instrument either [INPUT A] or [INPUT B].

On/Off of training mode

- 1 Press the [TRAINING] key.
Each press of the key alternates "On" and "Off." When set to "On", the [TRAINING] key is illuminated, while the display shows the training mode screen.

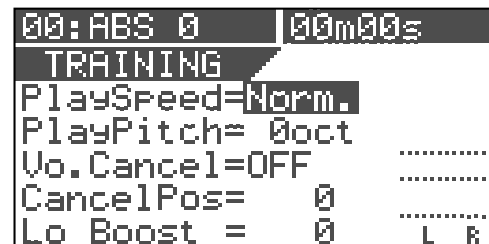

On the training mode screen, you can set the following. You can use the [CURSOR ▲/▼] key to select (highlight) the item to be set.

1. Playback speed
2. Playback pitch
3. On/Off of the center cancel function
4. Setting of the cancel position
5. Low boost setting (for emphasizing the bass sound)

<Note>

You can set the playback speed only while the VF80EX is stopped. The other items can be set both while stopped and during playback.

Slowing down the playback speed

You can change the playback speed only while the recorder is stopped.

- 1 When "Norm" in the "Play Speed" field is highlighted, use the [JOG] dial to select "Half."

The playback speed is set to half the normal speed and the pitch automatically raises one octave. To change only the pitch, see the next section.

```
00:ABS 0 | 00m00s
TRAINING
PlaySpeed=Half
PlayPitch=+1oct
Vo.Cancel=OFF .....
CancelPos= 0 .....
Lo Boost = 0 L R
```

- 2 To return to the normal speed, use the [JOG] dial to select "Norm."

The playback speed returns to the normal speed.

Changing the pitch

The following items can be set both while stopped and during playback.

- 1 Using the [CURSOR ▼] key to highlight the "Play Pitch" field, and then use the [JOG] dial to select the desired pitch.

You can set the pitch within the range of +/- one octave.

```
00:ABS 0 | 00m00s
TRAINING
PlaySpeed=Norm.
PlayPitch= 0oct
Vo.Cancel=OFF .....
CancelPos= 0 .....
Lo Boost = 0 L R
```

Canceling the center-positioned sound

- 1 Using the [CURSOR ▼] key to highlight the "Vo. Cancel" field, and then use the [JOG] dial to select "ON". You can cancel the center-positioned sound such as a lead vocal.

Depending on audio sources, you may not perfectly cancel the sound you want to remove because it is not exactly center-positioned. In such a case, perform the next operation.

```
00:ABS 0 | 00m00s
TRAINING
PlaySpeed=Norm.
PlayPitch= 0oct
Vo.Cancel=OFF .....
CancelPos= 0 .....
Lo Boost = 0 L R
```

Setting the cancel position

- 1 Using the [CURSOR ▼] key to highlight the "Cancel Pos" field, and then use the [JOG] dial to set the desired value.

You can select the cancel position from "-99" via "0" to "+99" in one step increments.

Try to find the best position where the sound to be cancel gets lowest.

```
00:ABS 0 | 00m00s
TRAINING
PlaySpeed=Norm.
PlayPitch= 0oct
Vo.Cancel=OFF .....
CancelPos= 0 .....
Lo Boost = 0 L R
```

Boosting the bass sound

- 1 Using the [CURSOR ▼] key to highlight the "Lo Boost" field, and then use the [JOG] dial to set the desired value.

You can select the low boost level from "0" to "10" in one step increments.

```
00:ABS 0 | 00m00s
TRAINING
PlaySpeed=Norm.
PlayPitch= 0oct
Vo.Cancel=OFF .....
CancelPos= 0 .....
Lo Boost = 0 L R
```

Playing along with the playback sound

- 1 Set the [MASTER] fader to the "0" position.
- 2 Press the [PLAY] key to start playback of the VF80EX and raise the Track 7/8 fader gradually. You can see the level is going up via the stereo output level meters (L and R) on the screen. Rotate the [PHONES] knob to adjust the headphones level.
- 3 Play the guitar along with the playback sound of Tracks 7/8, while adjusting the [TRIM] knob to the appropriate position where the [PEAK] indicator for the input you connect the guitar does not light.

You can hear both the playback sound of Tracks 7/8 and your guitar together from the headphones. If you move down the Tracks 7/8 fader, you can only hear your guitar.

Mastering mode

You can use Tracks 7/8 as the mastering tracks.

After performing the track bouncing from Tracks 1 through 6 to Tracks 7/8, you can record the audio signals on Tracks 7/8 to an external (analog or digital) master recorder while applying the "mastering effects" including EQ, reverb and compressor (see the illustration below).

You can perform the above operation in the mastering mode, which can be selected by the [MASTERING] key. When the mastering mode is active, only Tracks 7/8 can be played back, while the dedicated mastering effects are available. In the following description, we assume that the stereo mix signals are recorded on Tracks 7/8.

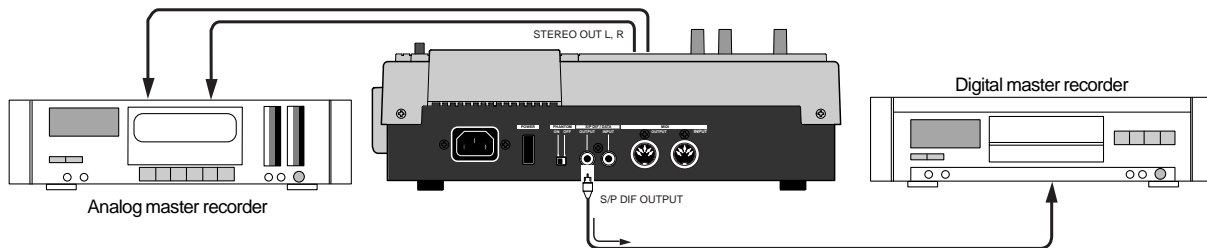

Selecting a program to be played back

If there is more than one program in the VF80, select the desired program to be played back. See "Selecting a program" for the operation.

On/Off of mastering mode

- Press the [MASTERING] key.**
 Each press of the [MASTERING] key alternates ON and OFF of the mastering mode. When the mastering mode is set to ON, the [MASTERING] key is illuminated and the following screen is displayed, while the [TRACK STATUS/TRACK SEL] key of Track 7/8 and the [STATUS/SEL] key for the master are illuminated in green.

```

00:ABS 0 | 00m00s
MASTERING L0:Flat
EQ Hi-G = 0dB [OFF]
EQ Mid-G = 0dB
EQ Lo-G = 0dB
Ambience = 0
CompTHSHD=-25dB L R
    
```

The screen example above shows the upper part of the mastering effect setting. Pressing the [CURSOR ▼] key scrolls down the setting items. To scroll up, press the [CURSOR ▲] key.

```

00:ABS 0 | 00m00s
MASTERING L0:Flat
Ambience = 0 [OFF]
CompTHSHD=-25dB
CompRatio= 4:1
CompGain =+10dB
▲CpProtect= OFF L R
    
```

The table below shows the mastering effect items.

Mastering library		You can select a desired preset entry from 10 entries (L0 through L9) stored in the effect library. See "Mastering library details" on the next page.
EQ	High Gain	Adjusts the EQ gain for the high frequency range within a +/- 18 dB range. Freq. and Q: fixed
	Mid Gain	Adjusts the EQ gain for the middle frequency range within a +/- 18 dB range. Freq. and Q: fixed
	Low Gain	Adjusts the EQ gain for the low frequency range within a +/- 18 dB range. Freq. and Q: fixed
Ambience	Rev Level	Adjusts the amount of reverb sound between 0 and 99.
	Rev Time	The values of these parameters for each entry are fixed (see "Mastering library details" on pages 77 and 78).
	Pre Delay	
Compressor	Threshold	Adjusts the threshold of the compressor between -50 dB and 0 dB in 1 dB steps.
	Ratio	Selects the compressor ratio from the following options. ∞:1, 20:1, 10:1, 8:1, 6:1, 5:1, 4:1, 3.5:1, 3:1, 2.5:1, 2:1, 1.7:1, 1.5:1, 1.3:1, 1.1:1, 1:1
	Gain	Adjusts the compressor gain between 0 dB and +18 dB.
	Attack	The parameter value for each entry is fixed (see "Mastering library details" on pages 77 and 78).
Copy Protect		Selects ON or OFF of the copy protection for the S/P DIF output signal. When set to ON, the flag for limiting a digital copy to one generation is set in the S/P DIF digital output signal.

<Hint>

When selecting a desired preset entry from the Mastering effect library, the initial parameter values of the entry are shown on the screen.
See "Mastering effect library details" on pages 77 and 78 for the detailed information.

Setting the mastering effect parameters

- 1 Set the [MASTER] fader at the "0" position.
- 2 Start playback and move up the Track 7/8 fader gradually.
You can monitor the playback sound of Tracks 7/8 by rotating the [PHONES] knob clockwise.
In the mastering mode, you cannot monitor the playback sound of other tracks even if you move up the faders.
- 3 Use the [CURSOR ▲/▼] keys to highlight the parameter value to be edited, and use the [JOG] dial to select the desired value.
You can monitor the tailored sound of Tracks 7/8 in realtime.

<Hint>

When any parameter value is changed from the initial setting, "E" appears on the right of the preset entry name (as shown below), showing that the current setting is different from the initial setting.

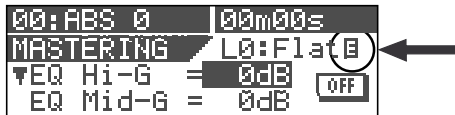

On/off of the mastering effects

- 1 To switch on or off the mastering effects, use the [CURSOR ▲/▼] key to highlight the ON/OFF icon as shown below, and use the [JOG] dial to select "ON" or "OFF".
When "ON" is selected, the tailored sound is output.
When "OFF" is selected, the original sound is output.

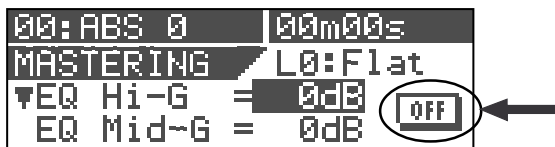

Recording onto the master recorder

- 1 Stand by the master recorder for recording, and start playback of the VF80EX.
You have to adjust the recording level now.
When the recording signal is digitally transferred from the VF80EX to the recorder, because a digital recorder usually does not provide the function for controlling the digital input level, you must adjust the recording level by controlling the stereo output level of the VF80EX using the [MASTER] fader.

- 2 After setting the recording level, return the VF80EX to the beginning of the program.
- 3 Start recording of the master recorder and then start playback of the VF80EX.
The stereo output (L and R) signals are recorded onto the master recorder.
- 4 After finishing recording, stop the both machines.

<Hint>

When you record VF80EX audio onto a digital master recorder via the S/P DIF digital signal, if the copy protection ("Cp Protect") is set to "ON", you can limit the digital copy from the master to another recorder.
If you do not want to make digital copies freely from the master, set the copy protection to "ON."

Mastering effect library details

The mastering effect library provides 10 preset entries which can only be used in the mastering mode. When applying mastering effects to the sound, you can use a desired preset as a starting point of your setting.

The following table shows the initial settings of EQ, reverb and compressor parameters.

L0: FLAT				<Comment> Basic mastering settings. Can be used for a wide range of music genre.
	Gain	Freq. (fixed)	Q (fixed)	
EQ Lo	0	400Hz	L-S	
EQ Mid	0	1kHz	1	
EQ Hi	0	4kHz	H-S	
Ambience	0 (Rev Level)			
Rev Time=1.0s / Pre Dly=0ms : fixed				
Comp THSHD	-25			
Comp Ratio	4 : 1			
Comp Gain	+10			
Attack Time = 8ms : fixed				
L1: Wet Mix				<Comment> Makes a dry sound wet.
	Gain	Freq. (fixed)	Q (fixed)	
EQ Lo	0	400Hz	L-S	
EQ Mid	0	1kHz	1.0	
EQ Hi	+4.0	8kHz	H-S	
Ambience	75 (Rev Level)			
Rev Time=0.5s / Pre Dly=0ms : fixed				
Comp THSHD	-30			
Comp Ratio	3 : 1			
Comp Gain	+10			
Attack Time = 5ms : fixed				

Advanced Operations (VF80EX)

L2: Light Mix

	Gain	Freq. (fixed)	Q (fixed)
EQ Lo	0	400Hz	L-S
EQ Mid	0	1kHz	1.0
EQ Hi	+4.0	8kHz	H-S
Ambience	0 (Rev Level)		
Rev Time=1.0s / Pre Dly=0ms : fixed			
Comp THSHD	-42		
Comp Ratio	3 : 1		
Comp Gain	+18		
Attack Time = 10ms : fixed			

<Comment>

Makes a dark sound bright.

L3: Live Mix

	Gain	Freq. (fixed)	Q (fixed)
EQ Lo	0	400Hz	L-S
EQ Mid	0	1kHz	1.0
EQ Hi	-18	8kHz	H-S
Ambience	99 (Rev Level)		
Rev Time=0.1s / Pre Dly=30ms : fixed			
Comp THSHD	-20		
Comp Ratio	1.5 : 1		
Comp Gain	+8		
Attack Time = 5ms : fixed			

<Comment>

Makes a sound like recorded in a small live house.

L4: Pop Mix

	Gain	Freq. (fixed)	Q (fixed)
EQ Lo	-3	400Hz	L-S
EQ Mid	-3	500Hz	2.0
EQ Hi	+2	4kHz	H-S
Ambience	80 (Rev Level)		
Rev Time=0.7s / Pre Dly=0ms : fixed			
Comp THSHD	-36		
Comp Ratio	3.5 : 1		
Comp Gain	+18		
Attack Time = 10ms : fixed			

<Comment>

Suitable for typical pop music with vocal.

L5: Dance

	Gain	Freq. (fixed)	Q (fixed)
EQ Lo	+10	400Hz	L-S
EQ Mid	-18	550Hz	3.5
EQ Hi	+15	10kHz	3.5
Ambience	0 (Rev Level)		
Rev Time=1.0s / Pre Dly=0ms : fixed			
Comp THSHD	-30		
Comp Ratio	5 : 1		
Comp Gain	+14		
Attack Time = 5ms : fixed			

<Comment>

Suitable for a dancing floor. A speedy sound which makes an audience excite.

L6: Hard

	Gain	Freq. (fixed)	Q (fixed)
EQ Lo	0	400Hz	L-S
EQ Mid	0	1kHz	1
EQ Hi	0	4kHz	H-S
Ambience	0 (Rev Level)		
Rev Time=1.0s / Pre Dly=0ms : fixed			
Comp THSHD	-36		
Comp Ratio	8 : 1		
Comp Gain	+18		
Attack Time = 5ms : fixed			

<Comment>

Powerful sound.

L7: 70s

	Gain	Freq. (fixed)	Q (fixed)
EQ Lo	-6	400Hz	L-S
EQ Mid	0	1kHz	1
EQ Hi	LPF-ON	6kHz	LPF
Ambience	0 (Rev Level)		
Rev Time=1.0s / Pre Dly=0ms : fixed			
Comp THSHD	-10		
Comp Ratio	5 : 1		
Comp Gain	+2		
Attack Time = 5ms : fixed			

<Comment>

Soulful and energetic sound of 70s'.

L8: Hall

	Gain	Freq. (fixed)	Q (fixed)
EQ Lo	+4	400Hz	L-S
EQ Mid	-4	500Hz	1
EQ Hi	-8	6kHz	H-S
Ambience	80 (Rev Level)		
Rev Time=3.0s / Pre Dly=100ms : fixed			
Comp THSHD	-25		
Comp Ratio	1.5 : 1		
Comp Gain	+5		
Attack Time = 8ms : fixed			

<Comment>

Makes a sound like recorded in a concert hall.

L9: LO_Fi

	Gain	Freq. (fixed)	Q (fixed)
EQ Lo	-18	400Hz	L-S
EQ Mid	+15	2kHz	1
EQ Hi	LPF-ON	2kHz	LPF
Ambience	0 (Rev Level)		
Rev Time=1.0s / Pre Dly=0ms : fixed			
Comp THSHD	-25		
Comp Ratio	∞ : 1		
Comp Gain	+5		
Attack Time = 5ms : fixed			

<Comment>

Narrow range sound by limiting the frequency range drastically.

Internal Mastering Mode

The internal mastering mode is an expansion of the mastering mode described earlier. It allows you to record a mixed-down material on tracks 7 and 8 to the current drive on the VF80EX while applying a mastering effect.

Therefore, unlike the mastering mode, this mode allows you to make high-quality mastering inside the VF80EX, without the need of an external master recorder.

By using the built-in CD-R/RW drive, you can burn original audio CDs from materials mastered in the internal mastering mode. See "Making an Audio CD" on page 125 for details.

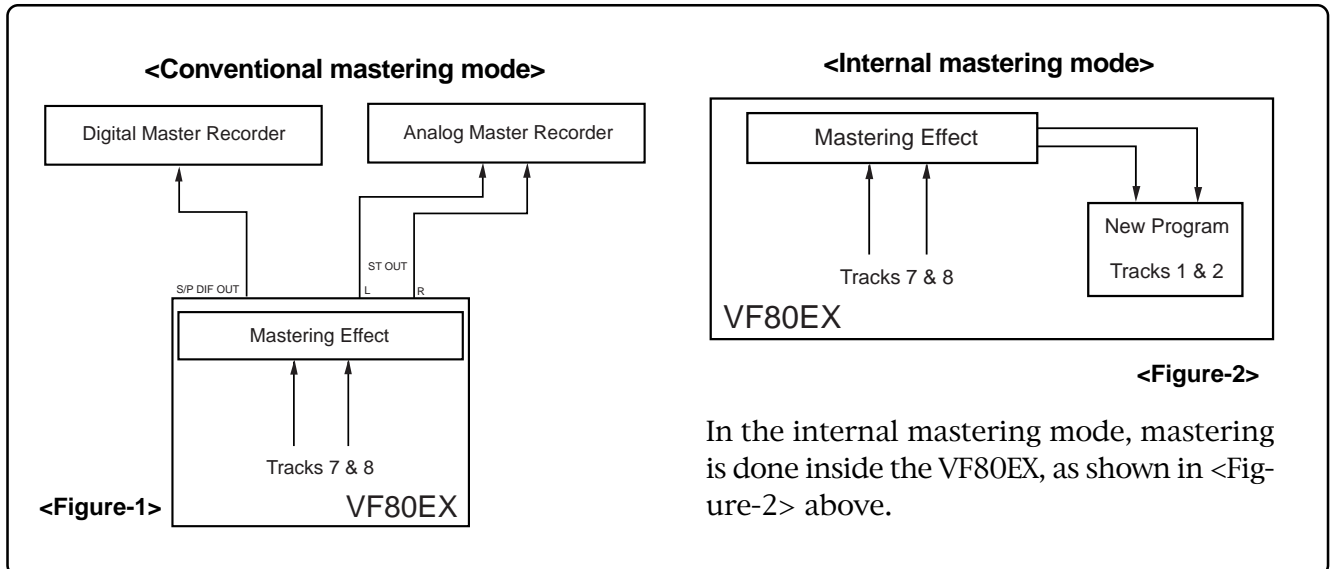

<Please read this first before carrying out operations in the internal mastering mode!>

After executing internal mastering, a new program which saves a mastered material is automatically created on the current drive, whose program number is set to one greater than the current greatest program number. For example, if there are 8 programs (P01 through P08) on the current drive, after mastering a desired program data using the internal mastering mode, a new program (P09) is automatically created and the mastered material is recorded on tracks 1 and 2 of P09.

Note that if the VF80EX is under either of the following conditions, you cannot carry out internal mastering.

1. There are 99 programs already existed on the current drive even though there is enough recording space.

If you try to carry out internal mastering, "Can't New PGM!" is shown and the operation is ignored. To carry out internal mastering, delete an unnecessary program.

2. There is not enough remaining space even though there are less than 99 programs on the current drive.

If you try to carry out internal mastering, "Over Time!" is shown and the operation is ignored. To carry out internal mastering, erase unnecessary song data or delete an unnecessary program.

See "Deleting a program" on page 62 and "Erasing track data" on page 66.

Rehearsing internal mastering

Before performing internal mastering, you can rehearse it as many times as you like, while adjusting the track 7/8 level and sound effects.

In the following description, we assume that a stereo pair of materials is recorded on tracks 7/8 of the current program and a pair of headphones is connected to the [PHONES] jack for monitoring.

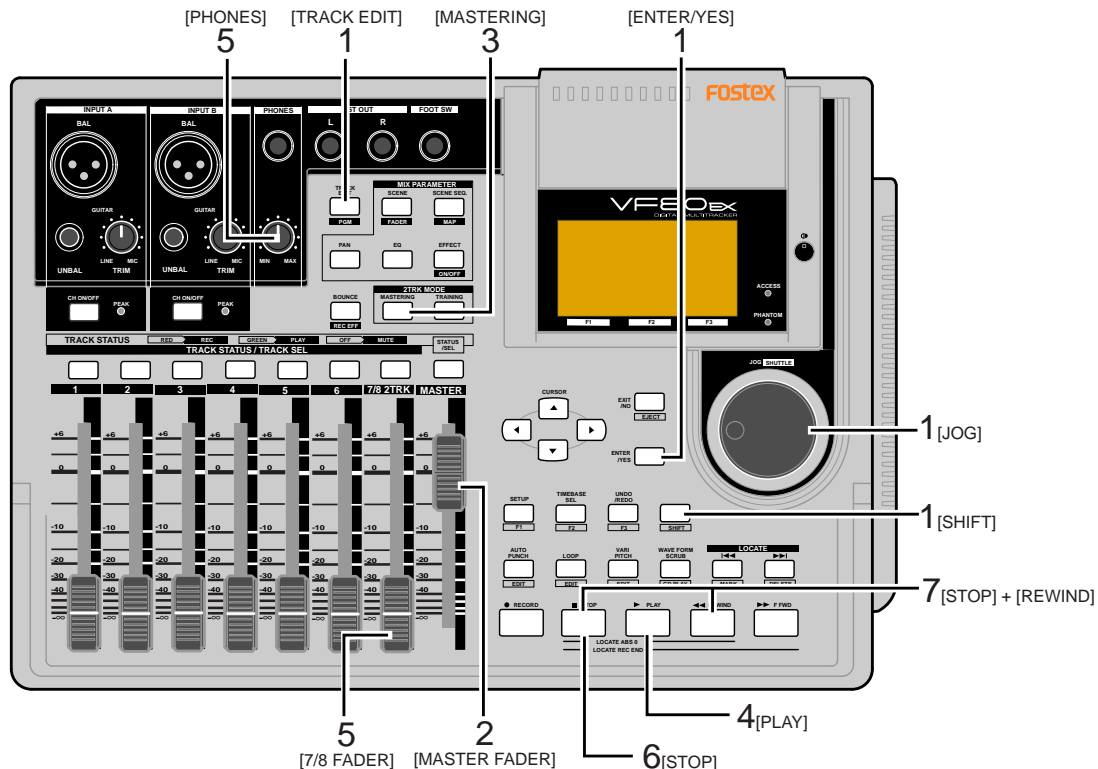

1 Select the desired program for mastering.

To select the desired program, while stopped, press the [TRACK EDIT/PGM] key while holding down the [SHIFT] key, and select the program using the [JOG] dial, then press the [ENTER/YES] key.

2 Set the [MASTER] fader to the "0" position.

3 Press the [MASTERING] key.

The VF80EX enters the mastering mode and the display shows the mastering screen in which you can adjust the mastering effects. The [MASTERING] key lights up in red, while the [TRACK STATUS/TRACK SEL] keys of tracks 7/8 and the master channel light up in green.

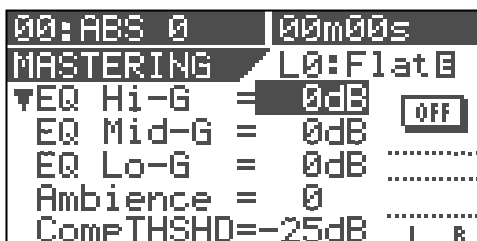

<screen for adjusting the mastering effects>

4 Press the [PLAY] key to start playback from the beginning of the selected program.

The VF80EX starts playback, while the display keeps showing the screen for adjusting the mastering effects. Tracks 1 and 2 are internally set to "input monitor", allowing you to check over-level via the peak LED indicators.

You can monitor the mastering sound through headphones by raising the track 7/8 fader and/or [PHONES] level control. The mastering levels are shown on the level meters at the right on the screen.

5 During playback, adjust track 7/8 levels using the 7/8 fader, as well as EQ and effect settings if necessary.

Set the levels properly so that the PEAK LED indicators do not flash or light frequently. Note that levels may increase by changing EQ or compressor parameters. When controlling the sound characters and level, you should not only monitor the level meters and listen to the sound, but also monitor the PEAK LED indicators.

To adjusting the mastering effect parameters on the mastering screen, use the [CURSOR] (▲ / ▼) keys to select a parameter and the [JOG] dial to change the parameter value.

<Hint>

On the mastering screen, you can tailor the sound by adjusting EQ settings (HI, MID and LOW), as well as the ambiance and compressor. See page 76 for details about the mastering effects.

<Note>

The "CpProtect" (Copy Protect) setting, which is one of the mastering effect items, does not affect a mastered material recorded by internal mastering. The copy protect setting affects materials recorded on a CD-RW/CD-R disc, described later. See "Making an audio CD" on page 125.

- 6** After completing all the adjustments, press the [STOP] key to stop the VF80EX.

- 7** Press the [REWIND] key while holding down the [STOP] key to locate to the beginning of the program.

The VF80EX locates to the beginning of the program immediately and "00m 00s" is shown at the top right of the screen. Keep showing the same mastering screen after stopping the VF80EX and locating to the beginning of the program.

To repeat the rehearsal, perform steps 4 and 5 repeatedly after making the VF80EX locate to the beginning of the program. After completing the rehearsal satisfactorily, make sure to locate to the beginning of the program.

<Note>

After completing the rehearsal, be careful not to move the track 7/8 and master faders and change the mastering effect parameters.

If you wish to do another work after the rehearsal, you should save the settings (fader positions and parameter settings) to a scene memory. See page 52 for details about the "scene memory" function.

Performing internal mastering

Before executing the take, read below, as well as notes on the next page.

<About Start and End points>

As described earlier, the starting and ending time values of internal mastering are automatically registered as the "Start point" and "End point" respectively, which are used for track editing (copy, move and erase) for the newly created program (see the illustrations below). When burning a CD-RW/CD-R, data between "Start point" and "End point" is automatically recorded. In other words, you cannot make an audio CD (described later) if these points are not set.

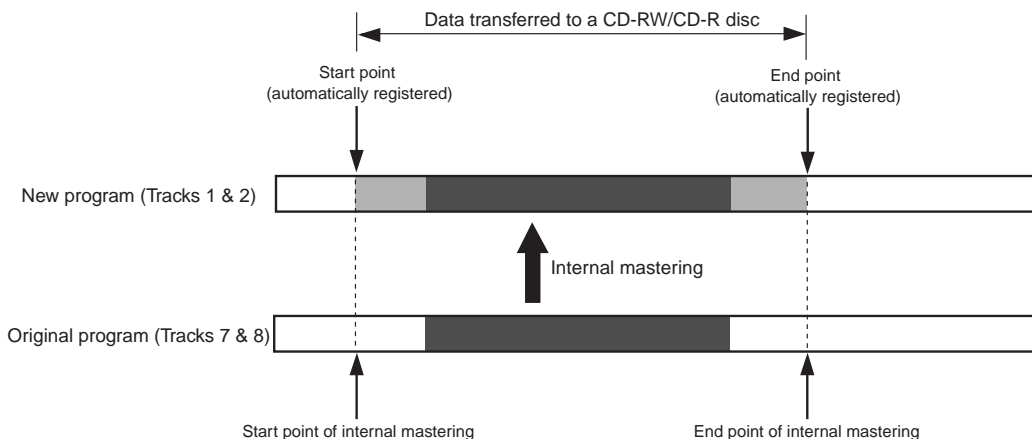

After executing internal mastering, you can check or edit the "Start point" and "End point" which have been automatically set. See page 83 for detail.

<Note: There is no need for selecting recording tracks.>

In the internal mastering mode, unlike the normal recording, you do not have to select recording tracks. When recording a take in the internal mastering mode, the VF80EX automatically arms Tracks 1 and 2. Therefore, the [TRACK STATUS/TRACK SEL] keys for tracks 1 and 2 never light up in red in the internal mastering mode.

<Note>

Internal mastering cannot be performed if rec-protected.

If the "Rec Protected" setting of the setup mode is set to "ON", you cannot perform internal mastering. If you try to perform it, a warning message ("Protected!") appears on the display. If this message appears, set the "Rec Protected" setting to "OFF" before performing internal mastering. See page 141 for details about the setup mode.

<Note: You cannot undo an internal mastering take.>

You cannot undo an internal mastering take. If you are not satisfied with the result, try again from the beginning. If you do not need a previously recorded program, delete the program according to the procedure described in "Deleting a Program" on page 62.

<Note: The vari-pitch setting is not effective.>

When recording a take in the internal mastering mode, the vari-pitch setting is not effective and the take is always recorded at the normal speed.

<About silence between songs>

As described on page 81, in the internal mastering mode, the starting and ending time values of a take are registered as the "Start point" and "End point" respectively.

If the song immediately starts at the beginning of the take and the take immediately ends when the song finishes, there may be no silent parts at the beginning and end of the mastered song.

Therefore, if you make an audio CD containing more than one song which is mastered as above, there may be no silent part between two adjacent tracks on the CD.

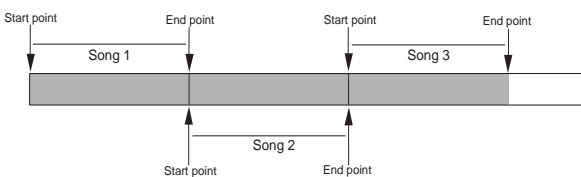

To avoid such a problem, we recommend to record "silence" by moving down the [MASTER] fader immediately after the song ends and press the [STOP] key after a few seconds (see the illustration below).

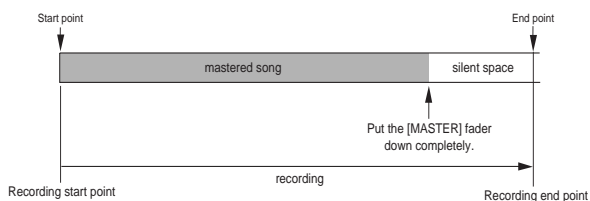

Note that you can also make a silent part later even if you make mastering without recording "silence". See "How to add a silent part to a mastered song" on page 83.

1 Press the [PLAY] key while holding down the [RECORD] key. (You cannot perform the auto punch-in function.)

When mastering starts, a new program is automatically created and the material is recorded onto tracks 1 and 2 of the program. The ABS time at which mastering starts is registered with the "Start point" of the new program.

2 When completing mastering, press the [STOP] key to stop.

"Please wait" appears on the display for a few seconds, and the internal mastering mode quits, while the VF80EX locates to the beginning (ABS 0) of the newly created program. The ABS time at which you press the [STOP] key is registered with the "End point" of the new program.

The following screen example shows that a title named "Song Data-1" is mastered onto a new program named "P09". As shown in the example below, "Mst<" is prefixed to a mastered program title, so that you can distinguish mastered programs from other programs.

The screen can show up to the first 12 characters of a title name.

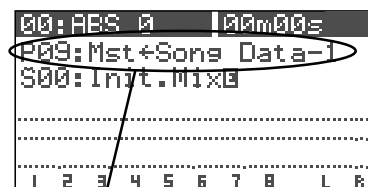

A title example recorded using the internal mastering mode.

3 Playback the newly created program (P09, in the example above) to check the result.

You can adjust the playback levels of mastered tracks using track faders 1 and 2.

Read the following "Hint" carefully before making an original audio CD from mastered materials.

Checking the "Start point" and "End point"

You can check the "start point" and "end point" which are automatically registered after finishing mastering. The following procedure is assumed that a mastered program is loaded.

- 1 Press the [TRACK EDIT/PGM] key while the VF80 is stopped.

The display shows the screen for track editing, where "Copy Paste" flashes.

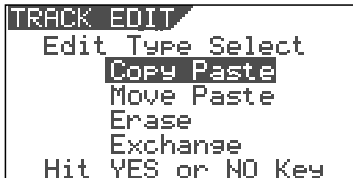

- 2 Press the [ENTER/YES] key.

The display shows the screen for selecting an original and destination tracks for copy/paste.

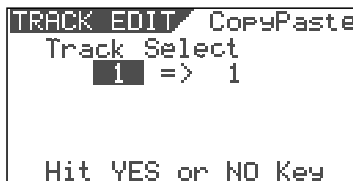

- 3 Press the [ENTER/YES] key again.

The display shows the screen for selecting edit points, in which you can check "Start" and "End" points that hold the beginning and end points of the recording respectively (pointed by arrows below).



- 4 After checking the "Start" and "End" points, press the [EXIT/NO] key to quit the track edit mode.

The display returns to the previous screen before performing step 1. See page 123 about how to make an audio CD from mastered materials.

<Note>

You can edit the "Start point" and "End point" before creating an audio CD, allowing adjustment of intervals between songs.

We recommend to set the "Start point" and "End point" of the new program created by the internal mastering function to desired time values before creating an audio CD.

How to add a silent part to a mastered song

Even if you have made mastering without recording a silent part, do not worry. You can make a silent part later by shifting the "End point" backwards using the track editing function.

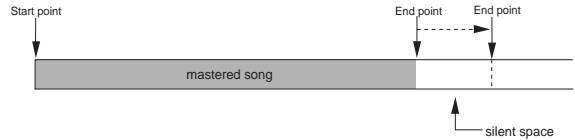

- 1 Press the [TRACK EDIT/PGM] key while the VF80EX is stopped.

The display shows the screen for track editing, as shown left.

- 2 Press the [ENTER/YES] key.

The display shows the screen for selecting tracks, as shown left.

- 3 Press the [ENTER/YES] key again.

The display shows the screen, as shown left, in which you can check "Start" and "End" points.

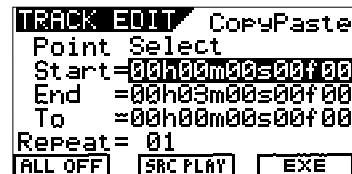

- 4 Press the [CURSOR/down] key to highlight the End point time data and press the [ENTER/YES] key.

Now you can edit the End point time data. Initially, the second field flashes.

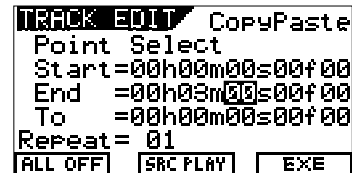

For example, if you wish to shift back the End point for five seconds from the current position ("00h03m00s00f00"), use the [JOG] dial to enter "05" while the second field flashes.

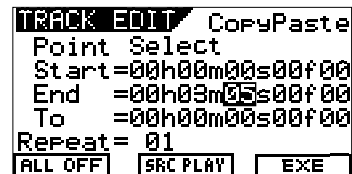

- 5 After finishing editing, press the [ENTER/YES] key.

The whole End point time data is highlighted and the new value ("00h03m05s00f00") becomes effective.

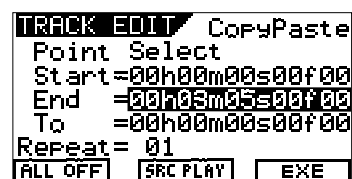

- 6 Press the [EXIT/NO] key repeatedly until the edit mode exits.

Using the insert effect

Unlike the loop effect described earlier in "Mixer Functions", the insert effect is applied when rerecording any recorded track among tracks 1 through 6.

This rerecording mode in which the insert effect is applied is called "REC EFFECT" mode.

Six distortion/simulation type effects are available for the insert effect. You can distort a guitar, bass, drums or vocal, as well as simulate a famous guitar amplifier or microphone character.

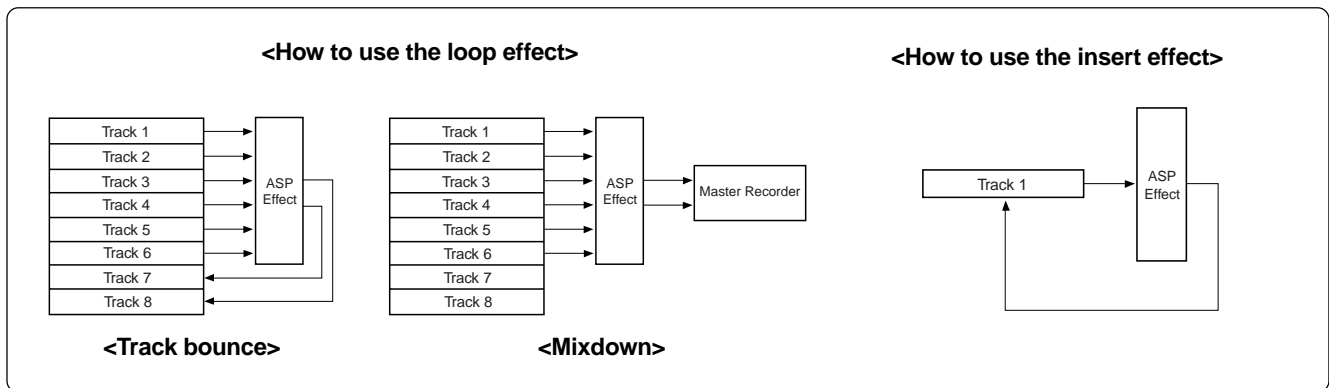

<Effect types available for the insert effect>

There are six effect types below available for the insert effect, in addition to 38 types for the loop effect as described earlier in "Mixer Functions".

See page 86 for details about parameters for each effect type.

"L39: Gtr Dist (guitar distortion)"

00:ABS 0	00m00s
EFF	L39:Gtr Dist
▼Dist Type	=Dist ON
Dist Gain	= 15
Warm	= ON
Bass	= 5
Middle	= 5 L R

"L42: Voice Dist (voice distortion)"

00:ABS 0	00m00s
EFF	L42:VoiceDist
▼Dist Type	=Voic1 ON
Dist Gain	= 15
Warm	= ON
Bass	= 5
Middle	= 5 L R

"L40: Bass Dist (bass distortion)"

00:ABS 0	00m00s
EFF	L40:Bass Dist
▼Dist Type	=Bass1 ON
Dist Gain	= 15
Warm	= ON
Bass	= 5
Middle	= 5 L R

"L43: Gtr Amp Sim (guitar amp simulator)"

00:ABS 0	00m00s
EFF	L43:GtrAmpSim
▼Type	=Brit800 ON
Amp Gain	= 8
Bass	= 10
Middle	= 10
Treble	= 10 L R

"L41: Drum Dist (drum distortion)"

00:ABS 0	00m00s
EFF	L41:Drum Dist
▼Dist Type	=Snar1 ON
Dist Gain	= 15
Warm	= ON
Bass	= 5
Middle	= 5 L R

"L44: Mic Sim (microphone simulator)"

00:ABS 0	00m00s
EFF	L44:Mic Sim
▼IN	=UsDen58 ON
Out	=UCon87
Gate	= OFF
Level	= 80
	L R

The following explains how to record a guitar solo to track 1 and rerecord it while applying the guitar distortion. Before executing recording, you can check the guitar sound with the distortion effect while rehearsing the effect parameter settings until you satisfy with the sound. We assume that the guitar is connected to the [INPUT A] connector and the VF80EX locates to the beginning of the program (ABS 0).

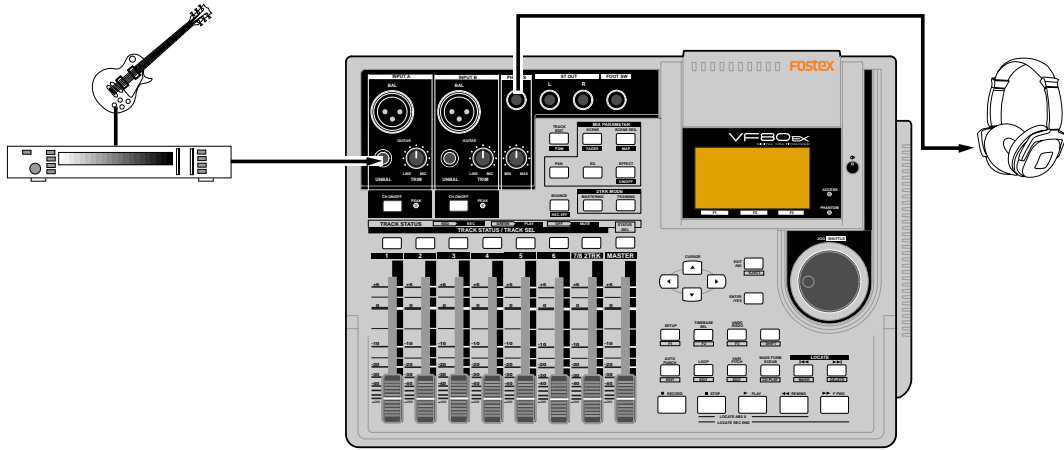

Rehearsal

You can check the guitar sound with an effect before recording. "L39:Gtr Dist" should be selected for the guitar distortion.

- 1** Press the [TRACK STATUS/TRACK SEL] key for track 1 to arm track 1.
Only the [TRACK STATUS/TRACK SEL] key for track 1 flashes, while the [CH ON/OFF] key lights.
- 2** Raise the track 1 fader and [MASTER] fader to the "0" position.
If these faders are not raised, you cannot monitor the sound.
- 3** Press the [RECORD] key.
Track 1 is switched to "Input monitor".
- 4** Adjust the gain appropriately using the [TRIM] control for [INPUT A] while playing the guitar.
You can monitor the guitar sound by raising the [PHONES] control.
- 5** Press the [EFFECT] key repeatedly until the effect type selection screen appears.
When you press the [EFFECT] key for the first time after turning on the power, "L01:Norm HALL" is shown as the effect type.

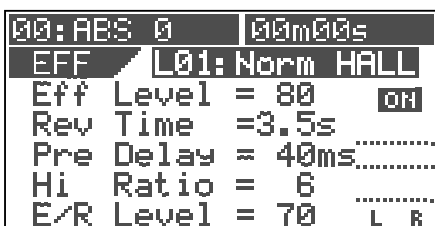

- 6** Use the [JOG] dial to select "L39: Gtr Dist" and press the [ENTER/YES] key.

"Insert Effect Selected!" is momentarily shown on the display, followed by the parameter setting screen for "L39: Gtr Dist".

Meanwhile, the [TRACK STATUS/TRACK SEL] keys for tracks 1 through 6 starts flashing, showing that you can select a track to which the effect is inserted.

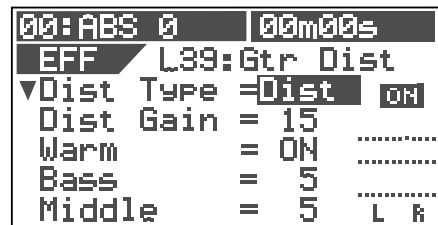

- 7** Press the [TRACK STATUS/TRACK SEL] key for track 1.
Only the [TRACK STATUS/TRACK SEL] key for track 1 flashes, showing that track 1 is selected.
- 8** Adjust parameters while playing the guitar to get the desired sound.

You can select a desired parameter using the [CURSOR] ▲/▼ keys and change the value using the [JOG] dial.

Before editing parameters, you can monitor the sound with the default parameter settings. The monitor sound changes in realtime when changing a parameter.

See the next page for details about the parameters for "L39: Gtr Dist".

<Caution!>

Do not raise the headphones volume too loud while monitoring the sound, which may damage your ears.

<How to edit parameters>

The "L39: Gtr Dist" effect type has 11 parameters as shown below. (Note that the screen example below shows all parameters for the explanation. Actually, you can see 5 parameters at a time while the other parameters are hidden.)

Use the [CURSOR] ▲/▼ keys to select a highlighted parameter. Use the [JOG] dial to select the value of the highlighted parameter.

The monitor sound changes in realtime when changing a parameter.

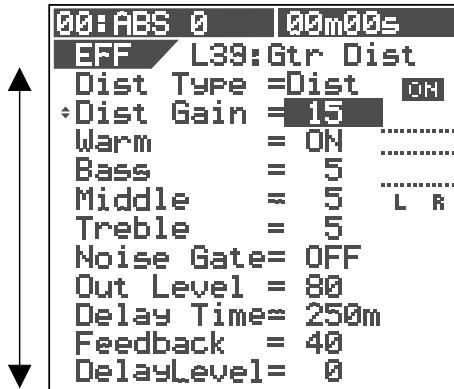

1. Dist Type	Selects a distortion type. Options: Acous, Rythm, OvDrv, Dist, Blues, Fuzz, Lead, Metal (Default: Dist)
2. Dist Gain	Adjusts the distortion gain. Range: 1 to 15 (The default depends on the distortion type selected.)
3. Warm	Makes the sound warmer when On. Options: ON, OFF (default: ON)
4. Bass	Adjusts the low frequency response. Range: 0 to 10 (default: 5)
5. Middle	Adjusts the mid frequency response. Range: 0 to 10 (default: 5)
6. Treble	Adjusts the high frequency response. Range: 0 to 10 (default: 5)
7. Noise Gate	Turns on or off the noise gate. Options: OFF, 1 to 99 (default: OFF)
8. Out Level	Sets the output level of the distortion. Range: 0 to 99 (default: 80)
9. Delay Time	Sets the delay time. Range: 5 ms to 1200 ms (default: 250 ms)
10. Feedback	Sets the feedback level of the distortion. Range: 0 to 99 (default: 40)
11. Delay Level	Sets the delay level. Range: 0 to 99 (default: 0)

<Storing parameter settings>

It will be a good idea to store a favorite parameter setting to a scene.

You can recall a stored setting whenever you like. See page 52 for details about the scene memory.

Recording the guitar

After making desired effect parameter settings in rehearsal, record the guitar while monitoring the effected sound.

Note that the dry sound is recorded though you monitor the wet sound.

We assume that track 1 is "Input monitor" (i.e. the [RECORD] key and the [TRACK STATUS/TRACK SEL] key for track 1 are flashing).

1 Press the [EXIT/NO] key to switch to the Normal screen.

2 Press the [PLAY] key while holding down the [RECORD] key to start recording and play the guitar.

The dry sound is recorded to track 1 while the wet sound is monitored.

The screen shows both the recording level of the guitar and the monitor level.

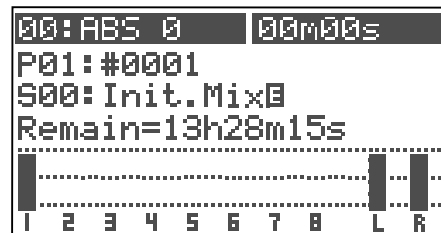

3 Press the [STOP] key to stop recording.

The [TRACK STATUS/TRACK SEL] key for track 1 still flashes, while the [RECORD] key turns off.

4 Press the [REWIND] key while holding down the [STOP] key to locate to the beginning of the program.

<To playback the recorded sound>

To check the recorded "dry" sound just recorded, press the [EFFECT] key while holding down the [SHIFT] key to turn off the effect, then press [PLAY] key to start playback.

If you do not turn off the effect, the "wet" playback sound is monitored with the effect you set in rehearsal.

Rerecording with effect

The final step is to rerecord the recorded "dry" sound on track 1 while applying the effect (guitar distortion) with the setting you made in rehearsal.

- 1 Press the [BOUNCE/REC EFF] key while holding down the [SHIFT] key.

The unit enters the REC EFFECT mode, in which you can apply the insert effect. The screen shows something like below.

The [BOUNCE/REC EFF] key and the [TRACK STATUS/TRACK SEL] key for track 1 flash.

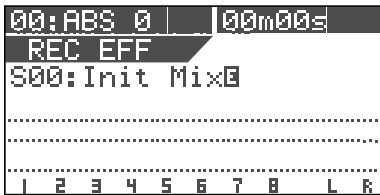

<Selecting a recording track>

When entering the REC EFFECT mode, the [TRACK STATUS/TRACK SEL] key for track 1 flashes. You can select any track to be recorded from among tracks 1 through 6 by pressing the appropriate [TRACK STATUS/TRACK SEL] key.

In this example, you are going to record to track 1, so you do not have to change the setting.

- 2 Press the [EFFECT] key.

The effect type selection screen appears, where "L39 Gtr Dist" is selected. All parameters are set as you did during rehearsal.

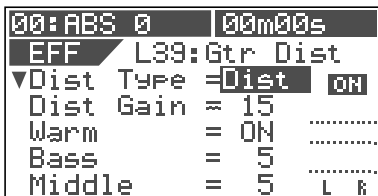

<Make sure that the effect is set to ON>

If the effect is set to OFF, press the [EFFECT] key while holding down the [SHIFT] key to switch it to ON.

<Check the recording level>

When applying the insert effect, you can adjust the recording level by the "Out Level" parameter. Before starting recording, check/adjust the recording level by following the procedure below. Note that the channel fader, [MASTER] fader, EQ and pan only affect the monitor sound.

1. Use the [JOG] dial to highlight the "Out Level" parameter.
2. Press the [RECORD] key to monitor the input.
3. Press the [PLAY] key to start playback from the beginning.
4. While monitoring the playback sound with applying the effect, adjust the "Out Level" value appropriately using the [JOG] dial so that the PEAK indicator does not light frequently.
5. After setting the level, locate to the beginning of the program.

- 3 Press the [PLAY] key while holding down the [RECORD] key to start recording.

During recording in the "REC EFFECT mode", the [BOUNCE/REC EFF] key is flashing in red.

- 4 Press the [STOP] key to stop recording.

- 5 Press the [BOUNCE/REC EFF] key.

The unit exits the REC EFFECT mode, and the [BOUNCE/REC EFF] key turns off, while the [TRACK STATUS/TRACK SEL] key for track 1 lights steadily in green.

- 6 Press the [REWIND] key while holding down the [STOP] key to locate to the beginning of the program.

- 7 Press the [EFFECT] key while holding down the [SHIFT] key to turn off the effect.

The [EFFECT] key turns off.

<Note>

Before playing back the rerecorded sound, always turn off the effect by the above operation.

If you playback the rerecorded sound while the effect is set to ON, you will monitor the "wet" sound with applying the effect.

- 8 Press the [PLAY] key to start playback from the beginning of the program.

You can confirm that the "dry" sound on track 1 is replaced with the "wet" sound.

<To cancel recording>

If you are not satisfied with the result, press the [UNDO/REDO] key to undo the last recording, and make recording again. Pressing the [UNDO/REDO] key once returns track 1 to the "dry" sound.

Pressing the [UNDO/REDO] key again returns track 1 back to the "wet" sound.

If you like, try recording in the similar manner by selecting the other effect type.

<Notes for the REC EFFECT mode>

- In the REC EFFECT mode, you can select an effect type only from among L39 through L44. If you enter the REC EFFECT mode from the condition in which an effect type for the loop effect is selected, "L39: Gtr Dist" will be initially selected.
- In the REC EFFECT mode, if you recall a scene in which the loop effect is used, the effect type is not changed. Or, when a track the insert effect is applied to is selected, if you recall a scene in which a track the insert effect is applied to is selected, the track selection is not recalled. In such a case, use the [TRACK STATUS/TRACK SEL] key to change the selection.
- In the REC EFFECT mode, You cannot set "Scene Sequence" and "Digital In" to ON. If you enter the REC EFFECT mode while one or both of these are set to ON, the unit automatically sets it (them) to OFF.
- In the REC EFFECT mode, you cannot playback or record tracks 7 and 8 (the [TRACK STATUS/TRACK SEL] keys never light up).
- To rerecord a desired part of a track with applying the insert effect, it will be a good idea to use the auto punch-in/out function. See page 33 for details about the auto punch-in/out.

• Parameters for distortion effects

(Parameter type: **DISTORTION**)

Effect types **No.39 through 42** (shown in "Effect type list" on page 49) are distortion types.

Each of these has 11 parameters as shown below.

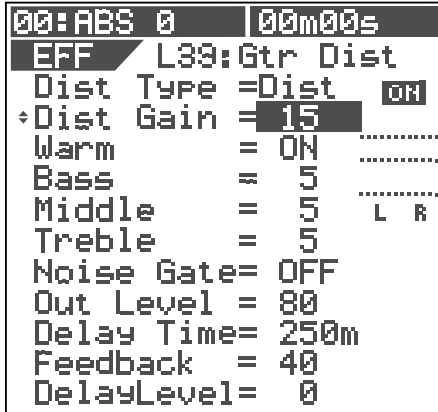

1. Dist Type	Selects a distortion type. Each effect type has following distortion type options. (An underlined option is the default.) L39: <u>Acous</u> , Rythm, OvDrv, <u>Dist</u> , Blues, Fuzz, Lead, Metal L40: <u>Bass1</u> , Bass2, Bass3 L41: <u>Kick</u> , Snar1, Snar2 L42: <u>Voic1</u> , Voic2, Voic3 See the table on the right for details about each type.
2. Dist Gain	Adjusts the distortion gain. Range: 1 to 15 (The default depends on the distortion type selected. See the table on the right.)
3. Warm	Makes the sound warmer when On. Options: ON, OFF (default: ON)
4. Bass	Adjusts the low frequency response. Range: 0 to 10 (default: 5)
5. Middle	Adjusts the mid frequency response. Range: 0 to 10 (default: 5)
6. Treble	Adjusts the high frequency response. Range: 0 to 10 (default: 5)
7. Noise Gate	Turns on or off the noise gate. Options: OFF, 1 to 99 (default: OFF)
8. Out Level	Sets the output level of the distortion. Range: 0 to 99 (default: 80)
9. Delay Time	Sets the delay time. Range: 5 ms to 1200 ms (default: 250 ms)
10. Feedback	Sets the feedback level of the distortion. Range: 0 to 99 (default: 40)
11. Delay Level	Sets the delay level. Range: 0 to 99 (default: 0)

Details of each distortion type

Each distortion type (selectable for each of effect types No.39 through 42) can apply the effect as described below.

• Distortion types for "L39: Gtr Dist"

The default distortion gain value depends on the distortion type selected.

Name	Comment	Default Dist Gain
Acoustic	You can get an electric-acoustic guitar sound	1
Rhythm	You can get a slight distortion when picking the guitar strongly.	4
Over Drive	You can get a smooth distortion like driving a tube amplifier.	15
Distortion	You can get a hard distortion like driving a three-stacked amplifier.	15
Blues	You can get a fat overdrive sound.	15
Fuzz	You can get a rough sound with a fat low frequency range.	15
Lead	You can get a bright and smooth distortion.	15
Metal	You can get a shred sound.	15

• Distortion types for "L40: Bass Dist"

Bass 1	Simulates a bass amplifier.
Bass 2	You can get a sound like recording a distorted bass sound through a line.
Bass 3	You can get a fat bass sound.

• Distortion types for "L41: Drum Dist"

Kick	You can distort a kick sound appropriately.
Snar 1	You can distort a snar sound appropriately.
Snar 2	You can distort a snar sound excessively.

• Distortion types for "L42: Voice Dist"

Voic 1	You can get a smooth distortion.
Voic 2	You can get a boomy and bright distortion.
Voic 3	You can get a bullhorn sound.

• **Parameters for distortion effects**

(Parameter type: **AMP SIMULATION**)

Effect type **No.43** (shown in "Effect type list" on page 49) is the amp simulation type.

This effect type has 11 parameters as shown below.

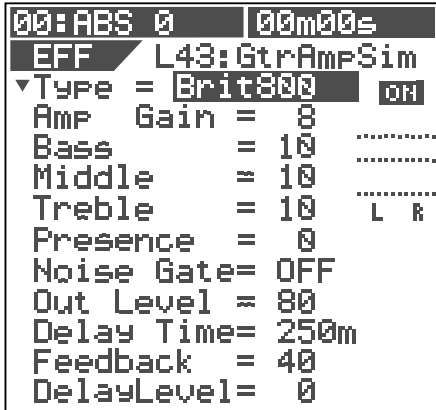

1. Type	Selects an amplifier type to be simulated. Options: Brit800, TremoRect, MetalRect, ClassA30, Fatman (default: Brit800) See the table on the right for details about each type.
2. Amp Gain	Adjusts the distortion gain. Range: 1 to 15 (The default depends on the distortion type selected. See the table on the right.)
3. Bass	Adjusts the low frequency response. Range: 0 to 10 (default: 10)
4. Middle	Adjusts the mid frequency response. Range: 0 to 10 (default: 10)
5. Treble	Adjusts the high frequency response. Range: 0 to 10 (default: 10)
6. Presence	Adjusts the presence (the feeling of being "up front"). Range: 0 to 10 (default: 0)
7. Noise Gate	Turns on or off the noise gate. Options: OFF, 1 to 99 (default: OFF)
8. Out Level	Sets the output level of the distortion. Range: 0 to 99 (default: 80)
9. Delay Time	Sets the delay time. Range: 5 ms to 1200 ms (default: 250 ms)
10. Feedback	Sets the feedback level of the distortion. Range: 0 to 99 (default: 40)
11. Delay Level	Sets the delay level. Range: 0 to 99 (default: 0)

Details of each amplifier types

Five guitar amplifier types can be simulated.

Each amplifier type has its own unique character as described below.

The default distortion gain value depends on the amplifier type selected.

Name	Comment	Default Amp Gain
Brit800	British 800 Amplifier Simulates the 800-series British tube amplifier, a synonym for "rock". The king of the rock sound of the 80's hard rock and heavy metal. Distorted raging sound.	8
TremoRect	Tremo Rect Amplifier Simulates the American combo model amplifier, designed to get high gain sound for the 90's hard rock and heavy metal. Fat bass and raging distorted sound.	15
MetalRect	Metal Panel Recti Amplifier Simulates the amp head of the high gain amp series, same as the Tremo Recti Amplifiers. Deep and well-separated distortion and heavy sound. Suitable for the metal sound.	15
ClassA30	British Class A 30 Amplifier Simulates a most popular British sound tube amplifier. The preamp section is designed using the class A circuit for creating the fat and warm sound. Usually used in the range between clear and crunch sound, but sometimes used with the higher gain to get a harder distortion.	2
FatMan	Fat Bass Amplifier Simulates the American combo amplifier designed as a bass amplifier but used by many guitarists because of its fat presence sound. Suitable for jazz and blues with its clear and crunch sound, however, because you can get a raging distortion that you cannot expect from an ordinary bass amplifier when raising the gain, it can be used for a wide range of genres.	5

• **Parameters for distortion effects**

(Parameter type: **MIC SIMULATION**)

Effect type **No.44** (shown in "Effect type list" on page 49) is the mic simulation type.

This effect type has 3 parameters as shown below.

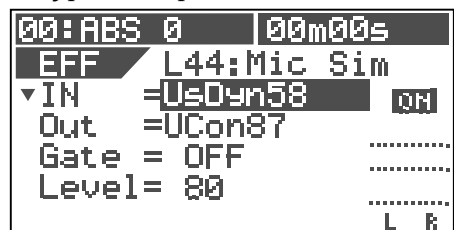

1. IN	Selects a microphone input type. Options: US Dyn 58 (dynamic type), MCon2 (condenser type) Default: US Dyn 58
2. Out	Selects a microphone output type to be simulated. Options: TCon3k , TCon3k LC , TCon414 , TCon414LC1 , TCon414LC2 , TDyn112 , GDyn421 , GDyn421LC3 , GDyn421LC2 , GDyn421LC1 , GDyn421SPE , MCon1 , MCon2 , MConV , UsDyn58 , VCon47 , VCon87 , VCon87 LC Default: VCon87 See the next page for details.
3. Gate	Adjusts the noise gate. Options: OFF , 0 to 99 (default: OFF)
4. Out Level	Sets the output level. Range: 0 to 99 (default: 80)

Details of microphone output types

18 options are available for the microphone output type, as shown below.

TCon 3k	Trad Condenser 3k (Low cut: Off) Simulates the sound of a multipurpose professional condenser microphone with a large diaphragm. Its warm and transparent sound is suitable for a vocal, as well as a drum overhead or guitar amplifier.
TCon 3k LC	Trad Condenser 3k (Low cut: On) Simulates the sound of "TCon 3k" above with the Low Cut switch to On. You can suppress boosted low frequencies as a result from placing a microphone in close proximity to the signal source.
TCon 414	Trad Condenser 414 (Low cut: On) Simulates the sound of one of the most popular condenser microphones in professional studios together with the Classic condenser 87. You can get a high-fidelity clean sound of an acoustic piano.
TCon 414 LC1	Trad Condenser 414 (Low cut: 75 Hz) Simulates the sound of "TCon 414" above with the Low Cut switch to On (75 Hz). You can suppress boosted low frequencies.
TCon 414 LC2	Trad Condenser 414 (Low cut: 150 Hz) Simulates the sound of "TCon 414" above with the Low Cut switch to On (150 Hz). You can suppress boosted low frequencies more than "TCon 414LC1".
TDyn 112	Trad Dynamic 112 Simulates the sound of a dynamic microphone suitable for a kick. You can get a clean and powerful sound by applying it to a kick or bass. It has a slightly boosted low frequencies.
GDyn 421	German Dynamic 421 Simulates the sound of a dynamic microphone which is frequently used for recording a tom-tom. Suitable for recording a skin percussion because of its powerful attack feeling with a high frequency peak.

GDyn 421 LC3	German Dynamic 421 (Low cut: 3) Simulates the sound of "GDyn 421" above with the Low Cut switch to On (3). You can suppress boosted low frequencies.
GDyn 421 LC2	German Dynamic 421 (Low cut: 2) Simulates the sound of "GDyn 421" above with the Low Cut switch to On (2). You can suppress boosted low frequencies more than "GDyn 421 LC3".
GDyn 421 LC1	German Dynamic 421 (Low cut: 1) Simulates the sound of "GDyn 421" above with the Low Cut switch to On (1). You can suppress boosted low frequencies more than "GDyn 421 LC2".
GDyn 421 SPE	German Dynamic 421 (Low cut: SPE) Simulates the sound of "GDyn 421" above with the Low Cut switch to On (SPE). You can considerably suppress boosted low frequencies. Suitable for a speech.
MCon 1	Modern Condenser 1 Simulates the sound of a modern condenser microphone which has a wider dynamic range and bright sound. It offers a warm tube sound, making a vocal or acoustic guitar as if it were recorded by a condenser microphone.
MCon 2	Modern Condenser 2 Simulates the sound of a condenser microphone offering wide dynamic range, like "MCon 1". It offers a flat frequency response and natural sound.
MCon V	Modern Condenser V Simulates the sound of a modern tube microphone with vintage feel. It offers a deep and natural sound which only tube microphones can provide. Suitable for a vocal, piano and ensemble.
Us Dyn 58	US Dynamic 58 Simulates the most popular dynamic handheld vocal microphone. High-end and low-end frequencies are not extended as compared with a condenser microphone.
VCon 47	Vintage Condenser 47 Simulates a professional tube microphone with a large diaphragm that offers clean and dry sound. Suitable for an acoustic guitar and brass.
VCon 87	Vintage Condenser 87 (Low cut: Off) Simulates the sound of a classic and historic model used for vocals and strings frequently in professional studios. Provides outstanding warm sound among condenser microphones.
VCon 87 LC	Vintage Condenser 87 (Low cut: On) Simulates the sound of "VCon 87" with low cut "On". You can suppress boosted low frequencies as a result from placing a microphone in close proximity to the signal source.

Digital recording

You can digitally record an external digital source to the VF80EX, or stereo output signals of the VF80EX to an external digital recorder. This section describes how to make digital recording between the VF80EX and an external digital device. **Note that the VF80EX can only handle S/P DIF format digital data.**

Recording an external source onto the VF80EX digitally

The following describes how to record an external S/P DIF digital source (such as CD, MD and DAT) onto the VF80EX.

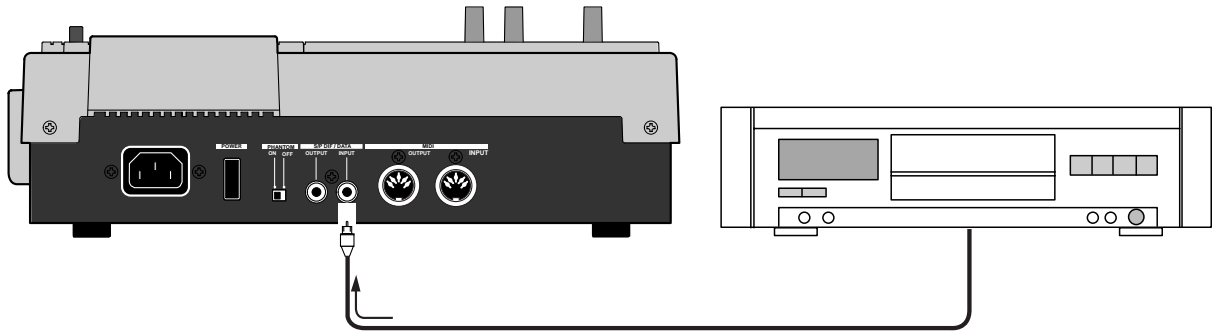

<Important note>

- When recording a digital source onto the VF80EX, make sure that the source signal is the "44.1 kHz, 16-bit" S/P DIF digital format.
- You can record an external S/P DIF digital source only onto Tracks 7/8 of the VF80EX. If you want to record it onto other tracks, first record it onto Tracks 7/8 and then move the data to other tracks using the track exchange function.

Selecting a program to be recorded

When more than one program exists, select the desired program using the program select function before recording.

See "**Selecting a program**" in "**Recorder function**" about how to select a program.

Selecting the digital input

- 1** In the "Digital In" menu of the setup mode, select "On." See "Setting digital input" in "Setup mode" about how to select "On." When set to "On", you can record an incoming S/P DIF signal from the [S/P DIF / DATA INPUT] connector onto Track 7/8 of the VF80EX.
- 2** After setting "Digital In" menu, press the [EXIT/NO] key to exit the setup mode. When receiving a correct S/P DIF digital signal, "DIGI IN" is shown steadily on the screen. When a correct digital signal is not received, "DIGI IN" blinks on the screen. In such a case, check the connection and settings of the external source device.

Selecting a track to record

- 1** Press the [TRACK STATUS/TRACK SEL] key of Tracks 7/8. The key lighting in green change to flashing in red.

Starting to record

- 1** Set the Track 7/8 and Master faders to the "0" position.
- 2** Start recording of the VF80EX by pressing the [PLAY] key while holding down the [RECORD] key, and start playback of the external digital device. "When recording a digital signal, you cannot adjust the input level of the VF80EX." "To get the optimum recording level, adjust the output level of the source." The level meters for Tracks 7/8 on the screen shows the input levels.

<Note>

During digital recording, the level meters for the stereo outputs (L and R) are not active.

- 3** Rotating the [PHONES] knob clockwise to monitor the source sound.
- 4** After finishing recording, stop the VF80EX by pressing the [STOP] key, as well as stop the external digital device.

<Note>

After you have finished the digital recording, return the "Digital In" setting to "Off." When "On", you cannot record any analog signal onto Tracks 7/8.

Recording the VF80EX stereo output signals digitally onto an external digital device

You can record the stereo output signal digitally onto an external digital device via the **[S/P DIF/DATA OUTPUT] connector**.

You do not have to carry out any special operation for outputting an S/P DIF digital signal from the **[S/P DIF/DATA OUTPUT] connector**, because it is always output there.

All you have to do for mixing down to an external digital device digitally is to connect the device to the **[S/P DIF/DATA OUTPUT] connector**. You can perform the digital mixdown during the mixdown process described in "Mixdown" of the "Basic recording/playback" chapter as well as in the mastering mode described in "Mastering mode" of this chapter.

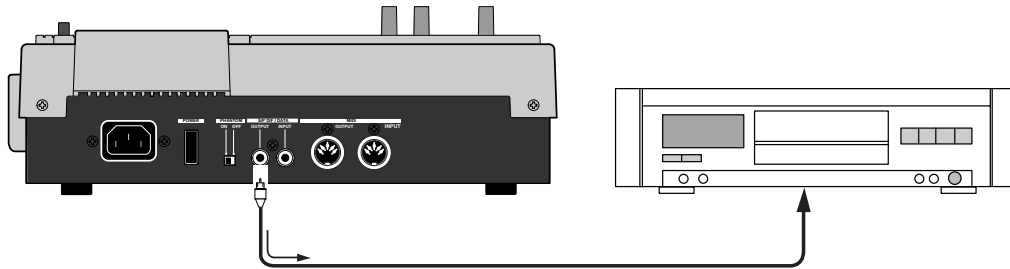

MIDI clock sync system

By setting any desired meter at any desired point of the programmable tempo map contained in the VF80EX, and by output of a MIDI clock and song position pointer according to the setting, a hardware type MIDI sequencer can be synchronized as a MIDI clock slave. Consequently, in this system, the VF80EX will be the master and the MIDI sequencer the slave.

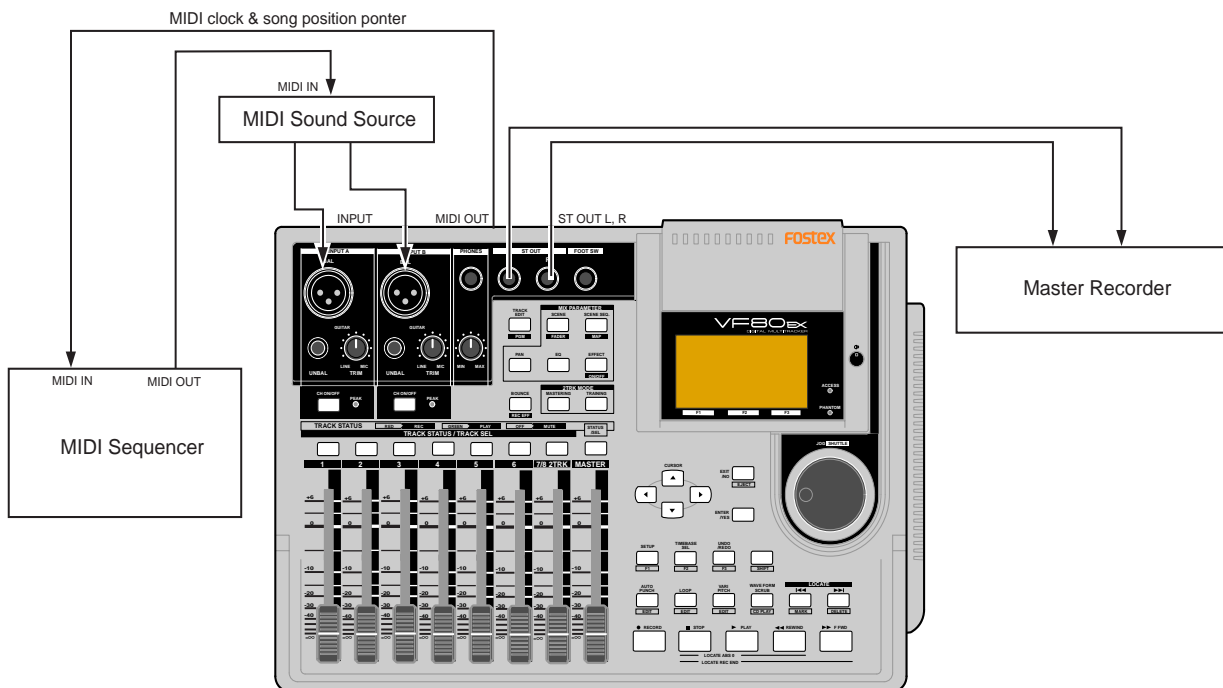

Connecting external equipment

1 Connect the VF80EX MIDI OUT to MIDI IN of the MIDI sequencer.

2 Set the MIDI sequencer for "external sync mode (EXTERNAL SYNC) by MIDI clock."

Refer to the Owners Manual of the equipment in use for details.

Setup of the VF80EX

- 1 **Because the MIDI clock and song position pointer will be output from the VF80EX, set the SETUP mode “MIDI sync signal output setting” to “CLK.”**
Refer to page “138”, SETUP mode “MIDI sync signal output setting” for correct operating procedures.
- 2 **The meter in the desired bar can be set by “Time signature setting” of the SETUP mode.**
Refer to page “134”, SETUP mode “Time Signature Setting” for operating procedure.
- 3 **Tempo in the desired bar can be set by “Tempo setting” of the SETUP mode.**
Refer to page “136”, SETUP mode “Tempo Setting” for operating procedure.
- 4 **Set the SETUP mode “Metronome setting” to “On” if click sound is to be output according to the setup tempo map.**
Refer to page “137”, SETUP mode “Metronome setting” for operating procedure.
- 5 **Press the [TIME BASE SEL] key, and then change the time base display to BAR/BEAT/CLK.**

Executing of recording

Various ways of recording can be conducted while synchronizing the VF80EX and the MIDI sequencer with the MIDI clock.

Confirming the MIDI clock sync

During recording and at playback following the recording, the time base (BAR/BEAT/CLK) is displayed in accordance to the setup tempo map, and the MIDI clock and song position pointer is also output.

Confirm that the travel position (BAR/BEAT/CLK) of the VF80EX and the travel position of the synchronized MIDI sequencer are matched.

If correct sync cannot be obtained, re-check the connections/cables and setting of both equipment.

<Note>

In the VF80EX, the “ABS 0” position is set at “-002BAR/1BEAT/00CLK.” This setting is made in consideration of the time required (it will not sync immediately) for the MIDI sequencer, etc. to enter into sync. As a result, if the VF80EX is played back from ABS 0 (LOCATE ABS 0), sync will be completed by the time it reaches the first bar, and will thus synchronize from head of the tune.

MTC sync/MIDI machine control system

The following will explain synchronization by the MTC (MIDI time code) output and the computer controlling system using MMC (MIDI machine control). In this system, the VF80EX will be the master and the computer (with sequence software) will be the slave. The VF80EX will attach any desired offset (time difference) against ABS time (absolute time) and output it as MTC in any desired frame rate. It can also carry out the proper operation upon receiving an MMC from outside. In this case, because the VF80EX can setup a DEVICE ID number by the SETUP mode “MIDI Device ID Setting” menu, a multiple number of the VF80EX’s can be separately controlled by changing the DEVICE ID numbers in the transmitted message from the computer.

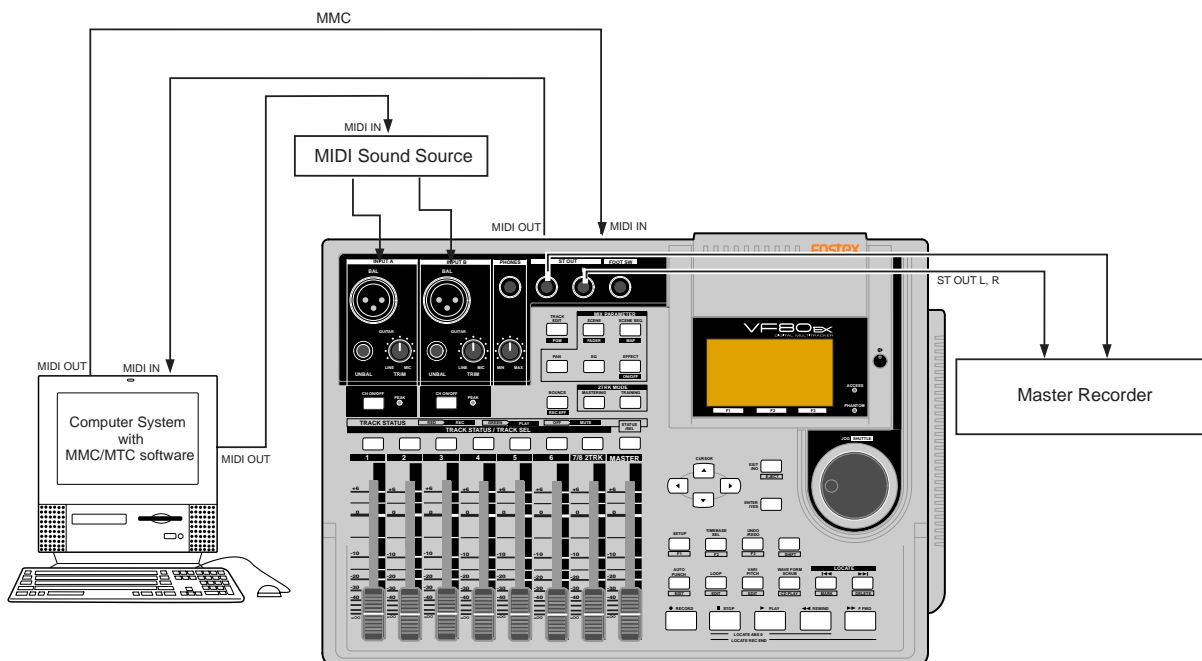

Connecting to external equipment

1 Connect the VF80EX MIDI IN/OUT to the computer (with MIDI interface) MIDI IN/OUT.

MMC/MTC complied sequence software is activated in the computer.

Setup of external equipment

1 Setup the following in the sequence software.

- * Set to MTC external sync mode (EXTERNAL SYNC).
- * Set for output of MMC.
- * Set to the desired MTC read out frame rate.
- * Set start time of the tune (which MTC time is to be the first bar). Refer to precaution in regards to MTC offset, farther on.

For details, refer to Owners Manual of the external equipment.

Setup of the VF80EX

1 Because MTC will be output from the VF80EX, set to "MTC" the SETUP mode "MIDI sync signal output setting."

Refer to page "138", SETUP mode "MIDI sync signal output setting" for operating procedure.

2 Set a random offset time by the SETUP mode "MTC offset time setting."

Refer to page "139", SETUP mode "MTC offset time setting" for operating procedure.

3 In the SETUP mode "MTC offset mode setting," whether the MTC offset time setup in Step 2 should be output (ABS) at the ABS 00m 00s 00f 00sf position or at the 001BAR 1BEAT 00CLK (bar, signature) must be selected.

Refer to page "139", SETUP mode "MTC offset mode setting" for operating procedure.

4 Setup to the same frame rate as that setup by the sequence software by "MTC Frame rate setting" of the SETUP mode.

Refer to page "138", SETUP mode "MTC Frame rate setting" for operating procedure and details.

5 Set to the same figure as the sequence software MMC device number by the SETUP mode "MIDI device ID setting."

When the sequence software transmits by "7F," it means "ALL DEVICE" and therefore, it need not be setup. Refer to page "143", SETUP mode "MIDI device ID setting" for operating procedure and details.

6 Press the [TIME BASE SEL] key, and then change the time base display to MTC.

<Notes on MTC related setups>

By "MTC offset time setting" and "MTC offset mode setting," at what position (ABS 0 or 001BAR/1BEAT/00CLK) should the setup MTC (MTC offset time) is to be output is set. When setting the start time of the tune in the sequence software by these setups, be careful of the following points.

• Offset mode: For ABS

If playback is started from ABS 0, since MTC will be output starting from the MTC offset time that has been set, the start time of the tune set by the sequence software must be set about 3 seconds later from the MTC offset time that was setup. This will provide time because the sequence software cannot sync immediately after MTC is output. For example, if the initial setting of "00h 59m 57s 00f 00sf" is used, set the start time of the tune to "01h 00m 00s 00f."

If playback is thus started from ABS 0 (LOCATE ABS 0), sync will be obtained by the time it reaches the first bar and therefore it can be made to sync from the head of the tune.

• Offset mode: For BAR

As mentioned before, because the "ABS 0" position is set at the "002BAR / 1BEAT / 00CLK" position, the setup MTC offset time can be set to the head of the tune without taking into account the time until reaching sync, as mentioned above. The length of the time two bars beforehand will change in accordance to the first bar setting for "signature" and "tempo." For example, it will be long if the tempo is set slow. This mode can be effectively applied when using the MIDI clock and MTC in parallel, and when using MTC for the sync signal while controlling the recorder with time base BAR/BEAT/CLK.

Confirming MTC sync/MMC

1 During recording and at playback after recording, time base MTC is displayed according to the setting and MTC is output at the same time.

Check that the VF80EX traveling position (MTC) and the traveling position of the sequence software in sync are matched.

2 Send MMC commands such as PLAY, STOP and LOCATE from the sequence software to see that the VF80EX will be properly controlled.

When a correct MIDI command (MMC or FEX) is received, "MIDI" in the display will be lit for about 40msec. There is no setting in the VF80EX to receive MMC but it will operate if a correct MIDI signal is input.

If sync and control cannot be done correctly, re-check connections/cables and the setting of both equipment.

Execution of recording

Carry out various recordings while synchronizing the VF80EX and a MIDI sequencer with the MIDI clock.

External MIDI equipment sync system by the slave mode

Up to this point, synchronization with external MIDI equipment has been explained with the VF80EX as the master and MIDI equipment as the slave but depending on the slave mode setting, the MIDI equipment can be set as the master and the VF80EX as the slave.

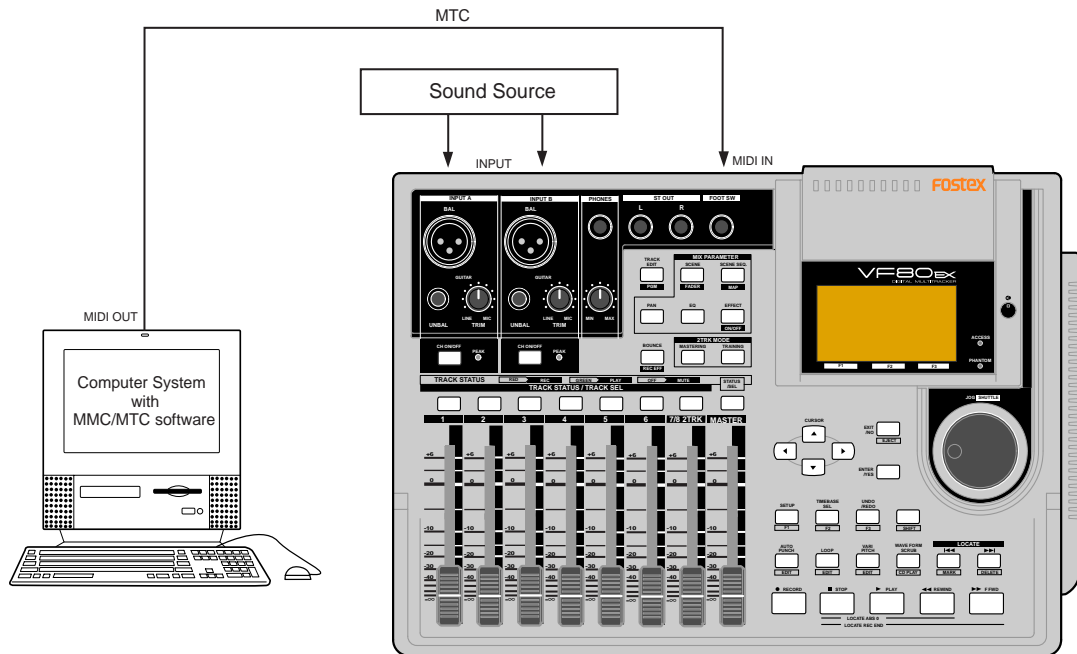

Connection to external equipment

- 1 Connect MIDI OUT of the computer (with MIDI interface) with MIDI IN of the VF80EX.
The computer sequence software complying to MMC/MTC must be activated.

Setup of external equipment

- 1 Sequence software is setup as follows.

- * Set for output of MTC.
- * Set frame rate of the MTC to be output.
- * Confirm start time of the tune.

Refer to Owners Manual of the respective equipment for details.

Setup of the VF80EX

- 1 Set to same frame rate as the sequence software by the SETUP mode "MTC Frame rate setting."
Refer to page "138", SETUP mode "MTC Frame rate setting" for operating procedure and details.
- 2 Set to the desired mode by the SETUP mode "MTC offset mode setting."
Refer to page "139", SETUP mode "MTC offset mode setting" for operating procedure and details.
- 3 A random offset time can be set by the SETUP mode "MTC offset time setting."
Refer to page "139", SETUP mode "MTC offset time setting" for operating procedure and details.

- 4 Set slave mode to "On" by the SETUP mode "Slave mode setting."

Refer to page "140", SETUP mode "Slave mode setting" for operating procedure and details.

- 5 Set slave type to "Vari" by the SETUP mode "Slave type setting."

Refer to page "140", SETUP mode "Slave type setting" for operating procedure and details.

- 6 Press the [TIME BASE SEL] key, to change the time base display to MTC.

Confirming chase lock

- 1 When the sequence software is played, "CHASE" and "MTC" in the display will be light and the chase lock will be completed.
Check that the MTC output by the sequence software and MTC time displayed in the VF80EX are the same.
- 2 When the sequence software stops, MTC will be interrupted and the VF80EX will also stop.
"CHASE" in the display will change from lit to blinking.
- 3 During FF/REW of the sequence software, the VF80EX will remain stopped but upon starting to record, the VF80EX will immediately chase lock.
Should it not be possible to chase lock, re-check connections / cables and all settings.

Execution of recording

Carry out various recordings while the recorder is chase locked to the sequence software.

<Precautions at MTC related setups>

The position (ABS 0 or 001BAR/1BEAT/00CLK) when the setup MTC (MTC offset time) should be output was setup by the “**MTC offset time setting**” and “**MTC offset mode setting**.” In accordance to start time of the tune set by the sequence software, setup as explained below.

Offset mode: For ABS

Set the MTC offset time about three seconds prior to the start time of the tune set by the sequence software. Because the recorder cannot immediately chase lock after input of MTC, in order to sync the unit from head of the tune, set the preroll using the sequence software, and playback from before the actual head of the tune to allow the recorder to enter into sync by the time it arrives at the head of the tune.

Offset mode: For BAR/BEAT

The MTC offset time can be set to the same time as the start time of the tune set by the sequence software. Because the “**ABS 0**” position is set at the “**002BAR/1BEAT/00CLK**” position in the unit, as mentioned before, the preceding time required for sync is already set. The preceding time of two bar lengths could change in length depending on the first bar’s “**signature setting**” and “**tempo setting**” mentioned before. For example, it will be longer if the tempo is slowed down.

<One Point Advice>

Sync signal “**Vari**” of the “**Slave mode setting**” menu:

When the VF80EX is made to chase lock by MTC only, variable pitch will be constantly applied by external MTC. If a digital signal is output to an external digital equipment from the VF80EX, it will not be able to follow the speed difference (MTC speed difference of the master) of the VF80EX and the external digital equipment, in some cases, may not be able to input a continuous digital signal.

As a counter measure, the sync signal should be set to “**Free**” by the “**Slave mode setting**” menu. Using this setting, the VF80EX will enter self operation by the internal clock, after completion of chase lock, and it will be possible to supply a stable digital signal to the external equipment.

Under this setting, when MTC drift between the master recorder and slave recorder exceeds 10 frames, the VF80EX will assume that chase lock has been disengaged and the slave recorder will carry out position matching again with the master unit (re-chase operation).

During the re-chase operation, sound output will be muted and the digital signal will also be interrupted. If it is within 10 frames, the slave recorder will continue to run while admitting this drift.

<Notes>

- Chase lock of the VF80EX by MTC only is permissible when speed difference of the MTC from the master is within +/- 5.6%.
Against the MTC within this range, variable pitch will be constantly applied internally for chasing. Chase lock, however, will not function against MTC at a speed difference outside this range. Also, when the master speed difference is large, it is advised to let the VF80EX learn the master speed by entering PLAY prior to recording. By doing so, it will be lock faster from the second and later sessions.
- Normally, when “**Setup of slave type**” is set to “**Vari**,” the VF80EX will be constantly controlled by vari-pitch and follow the MTC, which is the master. However, if the digital input is set to “**On**” via the SETUP mode “**Setup of digital input**”, it will be in “**Word clock external sync operation**” by the digital signal (S/P DIF) that is input.
Therefore, it must be noted that when “**Setup of digital input**” is executed, even though “**Setup of slave type**” is set to “**Vari**”, it will not follow by application of vari-pitch and upon completion of lock, it will change to external sync operation by the digital input signal.

Chain play function

The chain play function allows you to play back programs in order according to the "chain play list". As examples in figure 1, you can play back programs in order of program number or in desired order.

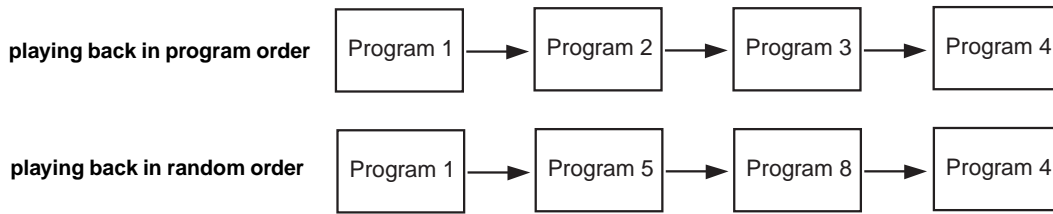

figure 1

You can play the whole (i.e. from ABS 0 to REC END) of each program in the chain play list as shown in figure 2, as well as a desired part(*) of each program as shown in figure 3.

<Note>

A desired part can be specified as a range between the START and END points. Therefore, if a program does not have both the START and END points which are correctly set, the whole program (from ABS 0 to REC END) is played back.

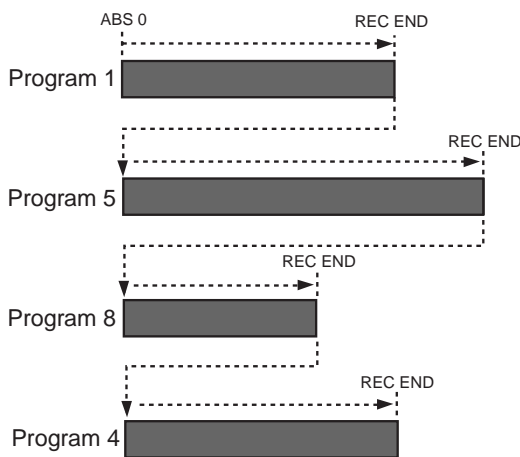

figure 2

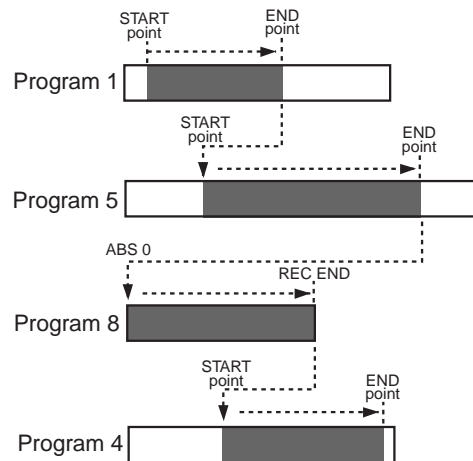

figure 2

In addition, you can select a playback mode for the chain play function from among "Pause", "A. Play" and "Repeat" (see below for details about each mode).

Pause	In this mode, the VF80EX plays back each program in the chain play list one by one. Each time the VF80EX finishes playback of a program, it automatically pauses at the start point of the next program. Pressing the [PLAY] key starts playback.
A. Play	In this mode, the VF80EX plays back all programs in the chain play list continuously. After finishing playback of the last program, the VF80 pauses at the start point of the first program. Pressing the [PLAY] key again starts playback of all programs in the chain play list continuously.
Repeat	In this mode, the VF80EX plays back all programs in the chain play list continuously and repeatedly until you press the [STOP] key.

Making the chain play list

Before executing chain play, you must make the chain play list by selecting the desired (or all) programs in the desired order. You can enter up to 99 programs to the chain play list.

The following procedure examples show how to enter all programs on the VF80EX current drive and how to select desired five programs to the list, assuming that 10 programs are recorded on the VF80EX current drive.

- 1 While the VF80EX is stopped, press the [SETUP] key. The VF80EX enters the setup mode and the display changes to show the "Select Menu" screen for selecting a setup menu item. By default, the "Signature Set" flashes as shown in the figure below.

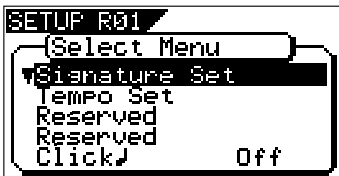

- 2 Use the [JOG] dial (or the [CURSOR ▼] key) to select "Chain Play List" which is the 27th menu item (R27) in the setup menu, and then press the [ENTER/YES] key. The display changes to show the "Chain Play List" screen, in which "C01:END" is highlighted by default. "C01" shows the step number, while "END" shows no program is entered to the chain play list.

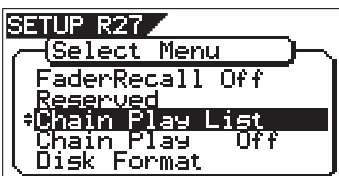

- 3 Press the [ENTER/YES] key again. "END" starts flashing and you can now enter a desired program to step 01.

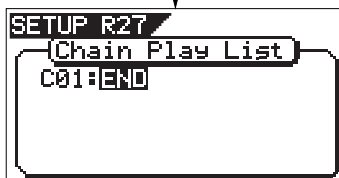
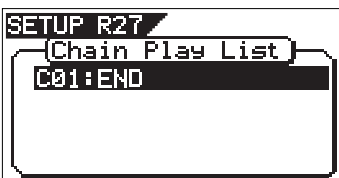

By rotating the [JOG] dial while "END" is flashing, you can select a desired option from among the programs on the drive ("P01" through "P10"), as well as "ALL", "INS" and "DEL". See the table below for details about each option.

END	The current and succeeding steps in the chain play list are all deleted. (See "Deleting all programs from the chain play list" described later for details.)
ALL	All programs on the current drive are entered to the chain play list. Note that you can select "ALL" to step 1 (C01) only. There is no "ALL" option on other steps. (See "Making the chain play list by selecting all the programs" described later for details.)
INS	A desired program can be added (inserted) to the current step. (See "Inserting a program to the chain play list" described later for details.)
DEL	The program on the current step is deleted. (See "Deleting a program from the chain play list" described later for details.)
P01 ~ Pnn	A desired program is entered to the current step. If another program is already entered, the new program overwrites it. You can select any of the programs on the current drive. (See "Making the chain play list by selecting desired programs" described later for details.)

Making the chain play list by selecting all the programs

The following procedure example shows how to enter all the programs (P01 through P10) on the current drive to the chain play list.

- 1 While "END" is flashing, rotate the [JOG] dial to select "ALL", and press the [ENTER/YES] key. By rotating the [JOG] dial to the left, you can find "ALL" easily. By pressing the [ENTER/YES] key after selecting "ALL", all programs on the current drive are entered to the chain play list, as shown in the screen example below.

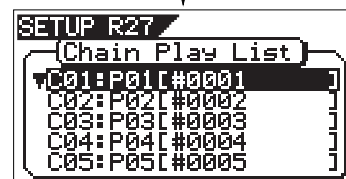

By rotating the [JOG] dial (or using the [CURSOR ▼/▲] keys), you can scroll through the list to check the chain play list. In the last line on the list, "C11: END" is shown, which shows that no more program is entered after step 11.

2 Press the [EXIT/NO] key.

The chain play list is made and the "Chain Play List" screen is dismissed. The display returns to the "Select Menu" screen, where the current option of the "Chain Play" menu item flashes (by default, "Off" flashes) and you can now set the chain play mode.

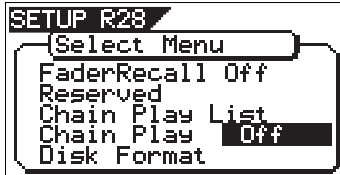

For details about how to set the chain play mode, see "Setting the chain play mode" on page xx.

<Note>

If a program which participates in the chain play list is deleted from the drive (see page 62 "Deleting a program" in the owner's manual), the whole play list is cleared (it returns to show "C01: END").

For example, if you are going to delete program 5 while programs 1 through 10 are entered to the chain play list, the warning message, "[WARNING] Play List Deleted", is shown on the display. Deleting program 11, for example, which does not participate the chain play list does not affect the chain play list.

Making the chain play list by selecting desired programs

The following procedure example shows how to enter the five desired programs (from among 10 programs on the current drive) to steps 1 through 5 in the chain play list, as below.

- : C01 -> program 5 (P05)
- : C02 -> program 3 (P03)
- : C03 -> program 1 (P01)
- : C04 -> program 2 (P02)
- : C05 -> program 4 (P04)

1 While "END" is flashing on the screen, rotate the [JOG] dial to select "P05" and press the [ENTER/YES] key.

You can select the desired program by rotating the [JOG] dial to the right.

When selecting the program, the first nine characters of the program name is also shown (in the example below, the name is "#0005").

After selecting "P05" and pressing the [ENTER/YES] key, program 5 (P05) is set to step 1 (C01) of the chain play list and the screen changes as shown below.

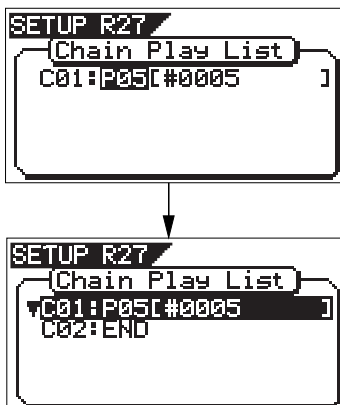

2 Use the [JOG] dial (or the [CURSOR ▼] key) to highlight "C02: END" and press the [ENTER/YES] key.

As with procedure step 1) above, "END" of "C02: END" starts flashing.

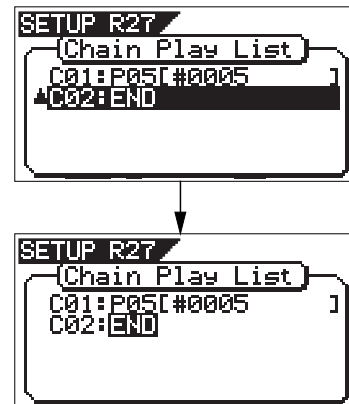

3 While "END" is flashing on the screen, rotate the [JOG] dial to select "P03" and press the [ENTER/YES] key.

As with procedure step 1) above, program 3 (P03) is set to step 2 (C02) of the chain play list and the screen changes as shown below.

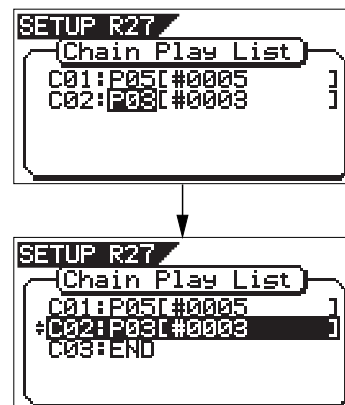

Set programs to steps 3 through 5 (C03 through C05) of the chain play list with the same manner as above.

4 After completing setting all the desired programs to the chain play list, press the [EXIT/NO] key.

The chain play list is made and the "Chain Play List" screen is dismissed. The display returns to the "Select Menu" screen, where the current option of the "Chain Play" menu item flashes (by default, "Off" flashes) and you can now set the chain play mode.

For details about how to set the chain play mode, see "Setting the chain play mode" on next page.

Setting the chain play mode

When you have made the chain play list, set the chain play mode. The following procedure shows how to set the chain play mode after making the chain play list as described before.

- 1 While "OFF" which is the current option of the "Chain Play" mode setting is flashing on the screen, rotate the [JOG] dial to select a desired chain play mode option. You can select a chain play mode option from among "Pause", "A. Play" and "Repeat", besides "Off". See page 97 for details about each chain play mode option.

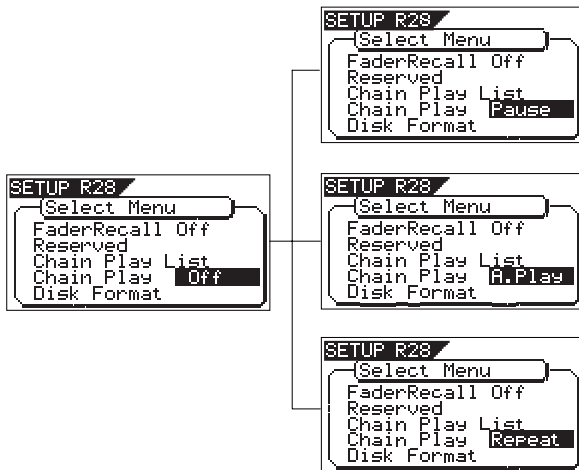

<Notes>

- The chain play mode setting returns to the default setting ("Off") when turning off the power or executing play list editing (described later). Therefore, each time you want to carry out chain play after turning on the power or executing play list editing, you must set the chain play mode.
- If you are going to set the chain play mode while the chain play list has not been made, "[WARNING] Illegal Play List!" is shown and the setting is invalid.

- 2 After selecting the desired option, press the [ENTER/YES] key.

The chain play mode is set to the selected option, while the setup mode exits and the display shows the start point (the ABS 0 or START point) of the program set to step 1 ("C01") in the chain play list. The following shows the screen example of setting the chain play mode to "A. Play".



This example shows that program 1 (P01) is set to step 1 (C01) and the start point is ABS 0. If the START and END points are set, the time at the START point is shown.

By pressing the [PLAY] key while the screen above is shown, chain playback starts in the selected chain play mode according to the chain play list.

<Notes when the chain play mode is set to any option but "Off">

- When the chain play mode is set to any option but "Off", you cannot make the auto punch mode or loop mode active. If you are going to make either of them active, "[WARNING] Void! Chain Play" is shown and the operation is invalid.
- When setting the chain play mode to "Repeat" and exiting the setup mode, the recorder automatically starts playback from the start point (the ABS 0 or START point) of the first program in the chain list. (When setting the chain play mode to "Pause" or "A. Play" and exiting the setup mode, the recorder moves to the beginning of the first program in the chain list.)
- When the chain play mode is set to any option but "Off", you can change the current program (by [SHIFT] + [TRACK EDIT/PGM]) only from among the programs set to the chain play list (see "Selecting a program from the chain play list" on page 8).

<Notes on playing back the chain play list>

When the play mode is set to any option but "Off", the recorder immediately locates to the start point of the program set to step 1 (C01) in the play list, and then stops. If you move the recorder to a position out of the range between the START and END points (or after the REC END point), "Out of Zone" is shown instead of the step number. In such a condition, the recorder does not correctly execute chain play. The worst case is that you start chain play when the recorder position is after the END point (or the REC END point). The recorder never moves to the next program.

To move the recorder to the start point of a program, reselect a program you want to start chain play from by following the procedure described below.

Selecting a program in the chain play list

If the play mode is set to any option but "Off", you can select a program only from those set to the chain play list. By selecting a program, you can start chain play from the desired step in the chain play list.

<Note>

If you want to select any program on the disk, as usual, turn off the power and then on, or set the chain play mode to "Off" (see "Setting the chain play mode").

In the following procedure, it is assumed that the chain play list has been made, the play mode is set to an option but "Off", and the program set to the first step of the chain play list is loaded.

- 1 Press the [TRACK EDIT/PGM] key while holding down the [SHIFT] key.

The screen changes as below to show the current chain play list. Shows that the list continues under the screen you see now.

While this screen is shown, you can select the desired program by using the [JOG] dial (or the [CURSOR] keys).

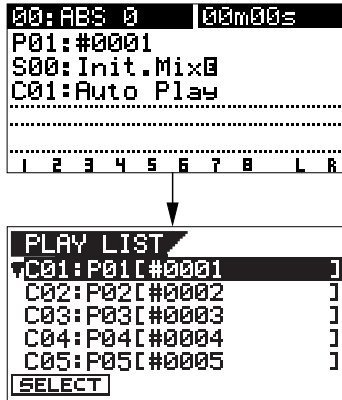

- 2 Use the [JOG] dial (or the [CURSOR] keys) to select the desired step and press the [ENTER/YES] key.

The program set to the selected step is loaded and the recorder is stopped at the beginning of the program (ABS 0), while the display shows the Normal screen. In the screen examples below, program 4 (P04) set to step 4 (C04) is selected.

Instead of pressing the [ENTER/YES] key in the procedure above, you may press the [SETUP/F1] key while holding down the [SHIFT] key.

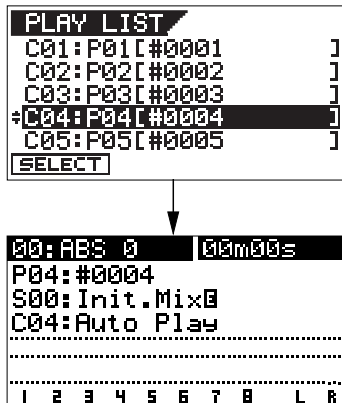

As described above, by selecting a program while the chain play mode is set to any option but "Off", you can start chain play from the desired program.

Editing the chain play list

You can replace a program in the chain play list with another program, delete a program from the list, or add a new program to the list.

Deleting (or replacing) a program in the chain play list

You can delete a desired program from the chain play list or replace a program in the list with another program by following the procedure below.

- 1 While the recorder is stopped, press the [SETUP] key to enter the setup mode.

The screen for selecting a menu item in the setup mode appears.

- 2 Use the [JOG] dial (or the [CURSOR] keys) to select "Chain Play List", and press the [ENTER/YES] key.

The display changes to show the "Chain Play List" screen as below.

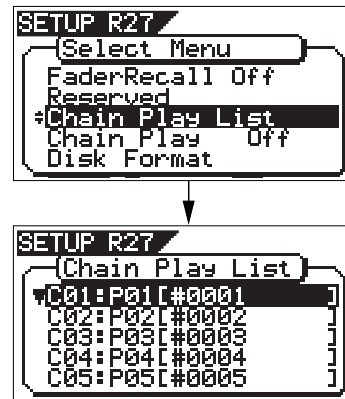

- 3 Use the [JOG] dial (or the [CURSOR] keys) to select the step you want to edit, and press the [ENTER/YES] key.

The program number set to the selected step starts flashing.

In the example below, "P03" which is set to step 3 (C03) is flashing.

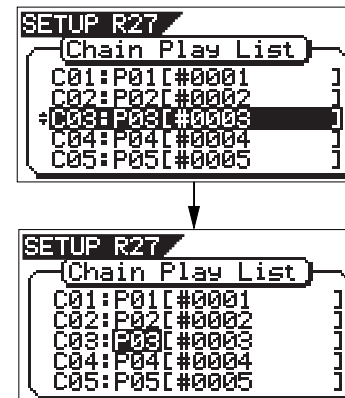

- 4 Use the [JOG] dial to select "DEL" (or a desired program) and press the [ENTER/YES] key.

To delete the program from the chain play list, select "DEL". To replace the program with another program, select a desired program. If you delete the program from the list, all the programs set to the subsequent steps automatically slide up, as shown below.

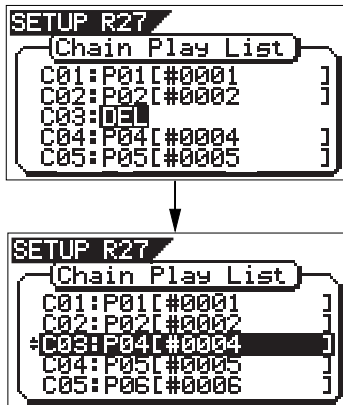

If you select a desired program, the program set to the selected step is replaced and other steps are not affected (in the following example, "P03" set to "C03" is replaced with "P08").

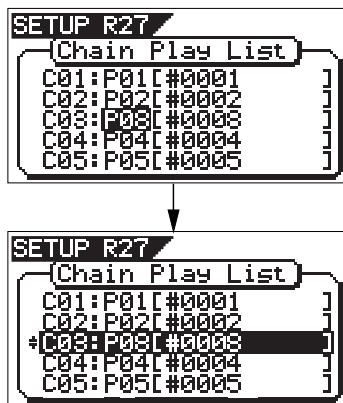

To delete (or replace) another program, repeat the procedure shown above.

5 Press the [EXIT/NO] key to exit the "Chain Play List" screen.

The display returns to the "Select Menu" screen where the current option of the "Chain Play" mode setting is flashing.

<Note>
 If you delete or replace a program in the chain play list when "Chain Play" is set to any option but "Off", the "Chain Play" setting automatically changes to "Off" (which is the default). Therefore, to execute chain play after editing the chain play list, you must make the "Chain Play" mode setting appropriately again.

Deleting all programs from the chain play list

You can delete all the program in the chain play list simultaneously.

1 While the recorder is stopped, press the [SETUP] key to enter the setup mode.

The screen for selecting a menu item in the setup mode appears.

2 While step 1 (C01) is highlighted (selected), press the [ENTER/YES] key.

The program number set to step 1 (C01) starts flashing. If step 1 ("C01") is not highlighted, use the [JOG] dial (or the [CURSOR] keys) to select step 1 and press the [ENTER/YES] key.

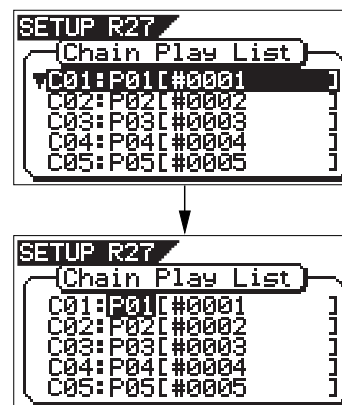

3 Use the [JOG] dial to select "END" and press the [ENTER/YES] key.

All the programs in the list are deleted at once and the screen shows as below ("C01: END" is shown in the chain play list, which means no program is entered to the list).

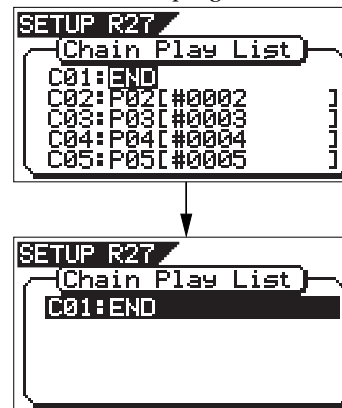

<Note>
 If you select any step but "C01" in procedure step 2) above and follow procedure step 3), programs set to the selected and subsequent steps are deleted from the list. For example, if you set "END" to step 3 (C03) in the chain play list where ten steps are currently set, programs set to steps 3 through 10 are all deleted, while programs set to steps 1 and 2 remain.

4 Press the [EXIT/NO] key repeatedly until the setup mode exits.

The "Chain Play" mode setting is automatically changed to "Off".

Inserting a program to the chain play list

You can insert a program to a desired step in the current chain play list.

<Note>

You can enter up to 99 programs to the play list. If you are trying to enter a program to the play list where 99 programs are already registered, "Void! Play List is Full" is shown and the operation is canceled.

- 1 Follow procedure steps 1) and 2) on page 9 to show the "Chain Play List" screen.

(i.e. enter the setup mode and select "Chain Play List".)

- 2 Use the [JOG] dial (or the [CURSOR] keys) to select a step where you want to add a program and press the [ENTER/YES] key.

The program number set to the selected step starts flashing. If you select "C02" on the left screen example below, "P02" starts flashing.

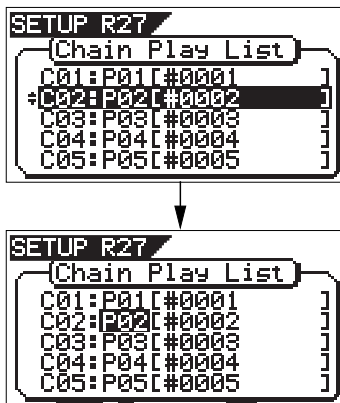

- 3 Use the [JOG] dial to select "INS" and press the [ENTER/YES] key.

You can now select a program to be inserted. Initially, "P01" flashes.

As you can see by comparing the two screen examples above, the programs set to the second and subsequent steps slide down automatically.

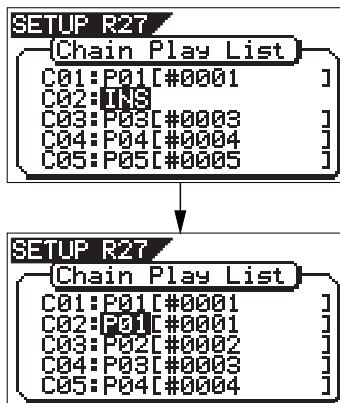

- 4 Use the [JOG] dial to select a program to be inserted, and press the [ENTER/YES] key.

In the example shown below, program 6 (P06) is inserted to step 2.

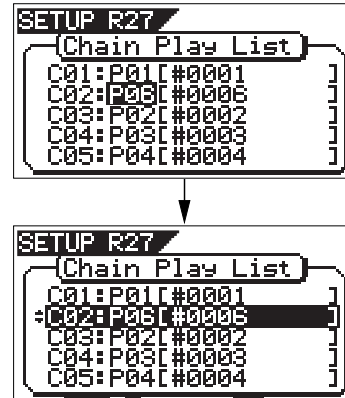

If you want to insert a program to another step, repeat the same procedure above.

- 5 After inserting all desired programs, press the [EXIT/NO] key.

The "Chain Play List" screen is dismissed and the display returns to the "Select Menu" screen where the current option of the "Chain Play" mode setting is flashing.

<Note>

If you insert the desired program(s) to the chain play list when the "Chain Play" mode is set to any option but "Off", the "Chain Play" setting automatically changes to "Off" (the default).

Therefore, to execute chain play after editing the chain play list, you must set the "Chain Play" mode appropriately again.

- 6 After setting the "Chain Play" mode appropriately, press the [EXIT/NO] key repeatedly until exiting the setup mode.

Audio CD playback mode

By switching the playback mode from the “internal HDD playback mode” to the “audio CD playback mode”, you can play back audio CDs created by the VF80EX (or commercially available audio CDs) using the built-in CD-R/RW drive.

<Notes>

- You cannot play back an audio CD which is copy-protected.
- Never try to play back a disc which is not an audio CD (CD-DA). This may damage the VF80EX.
- In the audio CD playback mode, you can use functions such as locate, scrub, loop and effect editing, as with internal HDD playback. However, note that the access speed is not guaranteed.

Switching the playback mode

When turning the power on, the VF80EX always starts up in the internal HDD playback mode. In the following description, it is assumed that the optional CD-R/RW drive is installed to the VF80EX and an audio CD (burned using the VF80EX or on the market) is inserted to the drive.

•When the HDD is stopped, press the [WAVE FORM SCRUB/CD PLAY] key while holding down the [SHIFT] key.

After the associated warning message as shown below appears, the playback mode changes. Executing the above operation alternatively switches the playback mode.

<Caution>

When switching the playback mode, make sure that the VF80EX is not accessing the CD-R/RW disc.

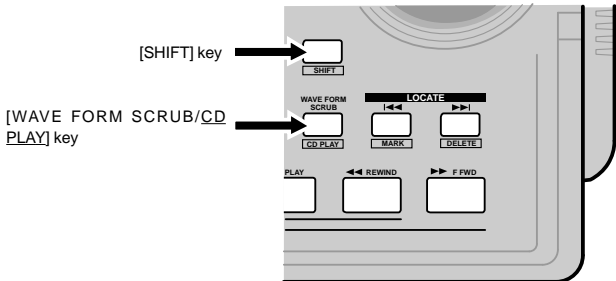

Internal HDD playback mode to Audio CD playback mode

Audio CD playback mode to Internal HDD playback mode

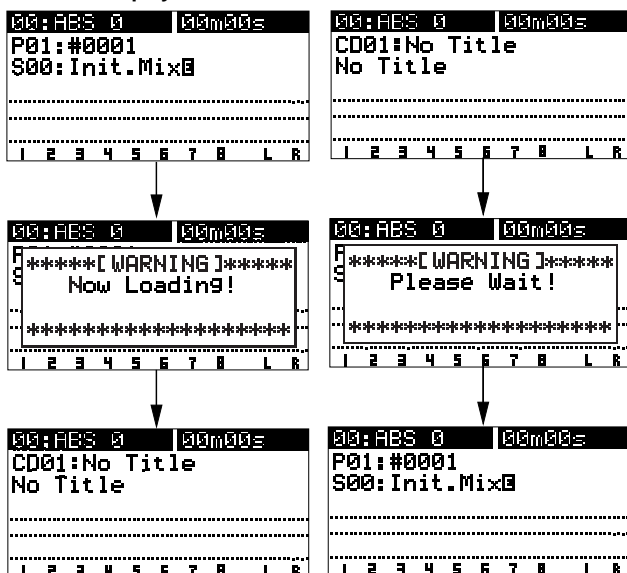

Available functions in the audio CD playback mode

In the audio CD playback mode, the following functions are available.

In the audio CD playback mode, only the [TRACK STATUS/TRACK SEL] keys for tracks 1, 2 and [MASTER] are lit, while the other [TRACK STATUS/TRACK SEL] keys are unlit, showing that only the faders for track 1, 2 and [MASTER] are effective.

This means that the playback level of the audio CD is adjusted using the faders for tracks 1, 2 and [MASTER].

If you are going to carry out any function other than the following, a warning message is shown and the operation is ignored (for example, if you press the [AUTO PUNCH] key, “[WARNING!] Void Key CD PLAYER” is shown.

• **Normal playback**

You can play back an audio CD with the same manner as with a program in the internal HDD. You can control the playback level using the faders for tracks 1, 2 and [MASTER].

<Note>

If you press the [PLAY] key, the key indicator flashes for a while. This shows that the system is in preparation for audio CD playback. When it is ready, playback starts.

• **Track skip**

If an audio CD contains more than one track, pressing [LOCATE >>I] or [LOCATE I<<] key skips a track.

By pressing the key, “Locate: MARK***” (** shows the mark number) is shown on the display, and the playback position skips (locates) to the beginning of the appropriate track.

• **Loop function**

By storing the loop start and end points correctly, you can use the loop playback function (which repeats playback between the specified points).

* For details about the loop function, see page 59 in the owner’s manual.

• **Varipitch playback**

You can use the varipitch playback function which allows to alter the playback speed within +/- 6.0 % range in 0.1 % increments/decrements.

* For details about the varipitch function, see page 58 in the owner’s manual.

• **Effect, EQ and pan controls**

You can use the effect, EQ and pan controls for tailoring the playback sound.

* For details about the effect function, see pages 37 and 45 in the owner’s manual.

* For details about the EQ function, see pages 37 and 42 in the owner’s manual.

* For details about the pan control, see pages 37 and 41 in the owner’s manual.

• **Audio CD eject**

In the audio CD playback mode and when the VF80EX is not accessing the disc, you can eject a disc in the CD-R/RW drive by pressing the [EXIT/NO] key while holding down the [SHIFT] key (or pressing the eject key on the CD-R/RW drive).

• **Display time mode selection**

By pressing the [TIME BASE SEL] key, you can select the time mode on the display from among “ABS”, “Track” and “MTC”.

Note that, in the internal HDD playback mode, the time mode can be selected from among “ABS”, “Bar/Beat” and “MTC”.

* See the below for details about the time display.

• **Display in the audio CD playback mode**

When switching to the audio CD playback mode, the display looks like the example below.

Each press of the [TIME BASE SEL] key switches the display time mode among “ABS”, “Track” and “MTC”, and the associated time information is shown. See the table below for details about each time mode.

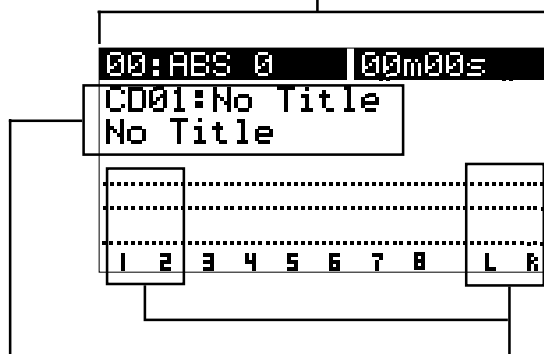

This section shows the current track number and name. In this example, “CD01” shows the current track number is “01”. On the right of the track number, the track name is shown when playing back a CD TEXT disc (an audio CD containing text information) which has track title information. If the name is long and exceeds the display area, it is scrolled in the next row.
When playing back a normal audio CD (which does not contain text information) available on the market or burned using the VF80, “No Title” is shown, as this example.
If the current audio CD has more than one track, pressing [LOCATE] or [LOCATE] key skips a track and locates to the beginning of an appropriate track, while “Locate: MARK***” is shown on the display.

In the audio CD playback mode, only the level meters for tracks 1, 2 and L/R master are effective. The playback level can be controlled using the faders for tracks 1, 2 and [MASTER].

ABS	Disc elapsed time is shown. The time starts from the beginning of a disc. The loop start and end points refers to disc elapsed time.
TRACK	Track elapsed time is shown. Track time starts from the beginning of each track. Naturally, at the point each track starts playback, the display shows “00m00s”.
MTC	MTC (MIDI Time Code) is shown. It has an offset of 59 minutes 57 seconds to “ABS 0” (the same offset as the internal HDD playback mode).

Save/Load of song data

You can save or load song data (including audio and setup data) using a digital audio recorder via the S/P DIF digital signal, as well as using the CD-R/RW drive (Model CD-1A/EX). This function allows you to save finished or unfinished song data to a digital recorder or the CD-R/RW drive, and load the data later.

*****About song data*****

There are two methods of saving/loading song data depending on the digital signals used to handle the data, which are S/PDIF digital and CD-R/RW drive. The data format and time required for the save/load operations are different between each method.

•Using the S/PDIF digital signal (you can save/load data for each program individually.):

Following to five seconds of the pilot signal (shown in gray in the diagram below), the song data is output to an external digital audio device such as a DAT recorder.

The audio data is divided into data blocks of track pairs (shown in black in the diagram below) and transferred. To save data for Real tracks 1 through 8, 4 two-track data are transferred. To save all tracks including the Additional tracks in addition to the Real tracks, 12 two-track data are transferred. Therefore, it will take about 4 times as much as the recorded time of a program (from ABS 0 to REC END) to save the Real tracks 1 through 8 of the program, while it will take about 12 times to save all the data including the Additional tracks.

When loading song data from the external device to the VF80EX via the S/PDIF digital signal, data is transferred with two-track data blocks, as with the same way as saving data from the VF80EX to the external device. (See also <Notes> on the next page.)

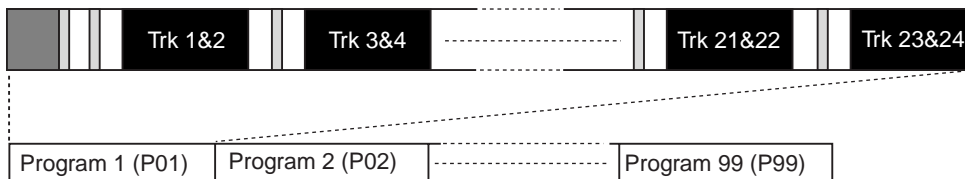

•Using a CD-RW/CD-R disc (you can save/load data for each program individually.):

When using a CD-RW/CD-R discs, all audio data including both the Real and Additional tracks (shown in black in the diagram below) is transferred simultaneously. Therefore, you can save or load a program much faster than using the S/PDIF signal. Note that no pilot tone or beep sound is recorded when saving data to a CD-RW/CD-R discs. If song data to be saved requires more space than the available disk space, you can save the data to more than one disk (up to 99 disks). You can also save/load data by the WAV file format. In the save/load operation using the WAV file, you can specify any track(s) to be saved or loaded, as well as all tracks.

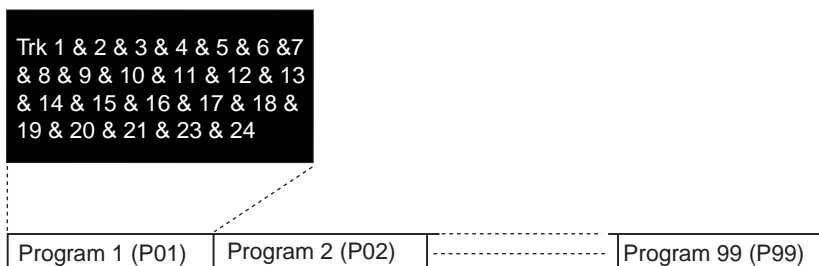

<Items that can be saved or loaded as song data>**•Memory data:**

AUTO PUNCH IN/OUT data and Start/End/To points,
Scene memories 00 through 99, Marks 00 through 99 (only can be saved/loaded using CD-R/RW drive)

•Timebase:

ABS, MTC or BAR/BEAT/CLK

•Setup mode:

Bar/beat setting, tempo setting, metronome on/off, preroll time, MIDI synchronization output signal setting, MTC offset time, MTC offset mode, REC protect setting, slave mode on/off, and slave type setting
Fader fix mode setting, fader recall mode setting

<Items that cannot be saved or loaded as song data>**•On/off settings for auto play mode and auto return mode****•Vari pitch on/off and pitch data****•Setup mode:**

DIGITAL IN and DIGITAL OUT settings, bar/beat resolution on/off setting, device ID setting and drive select setting

Saving/loading data using the S/PDIF digital signal**<Notes for digital audio recorders to be used>**

The VF80EX song data only can be saved to or loaded from digital recorders that can handle 16 bit, 44.1 kHz linear digital data with S/PDIF format (such as DAT recorders).

<Notes for saving data using the S/PDIF digital signal>

When saving all data including both real and Additional track data using the S/PDIF digital signal, note the following.

Only the data recorded within the time duration between ABS 0 and REC END of the Real tracks is saved. Therefore, if the recorded time of Additional tracks is longer than the Real tracks, only the Additional track data within the time duration between ABS 0 and REC END of the Real tracks is saved.

In the example shown on the right, the Additional tracks have data from "00m 00s" to "10m 00s", while the Real tracks have data from "00m 00s" to "07m 00s". If you are going to save all tracks, the Additional track data from "00m 00s" to "07m 00s" will be saved but the rest will not be saved.

In such a case, you can solve the problem by setting the time length of saved data to 10 minutes by using the "Save Length" screen mentioned later (see "step 4" on page 109). Note that the maximum save length is 59 minutes 59 seconds.

The other way to solve the problem is to exchange the Additional track data and the Real track data before saving data. You should be careful not to lose the Additional track data in this operation. See page 68 about the "track exchange operation".

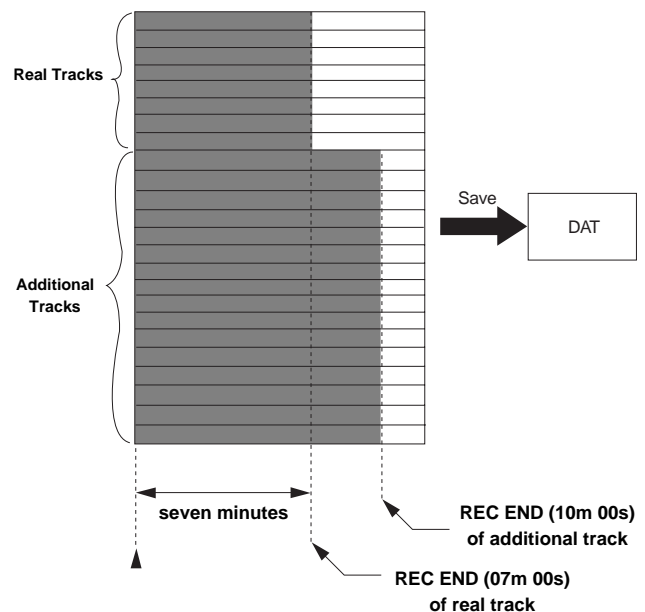

Saving data using the S/PDIF digital signal

You can save data using the S/PDIF digital signal via the [S/P DIF DATA OUTPUT] (coaxial) jack.

- Use an external digital recorder that supports 44.1 kHz sampling frequency (the same as the VF80EX),

Connecting to an external digital recorder

Connect the [S/P DIF DATA OUTPUT] jack to the digital input jack of the external digital recorder (DAT, etc.).

<Note>

Do not do anything, such as unplug the connecting cable, that interrupts the digital signal until the saving operation is completed. Otherwise, the unit may generate a noise which damages an external recorder.

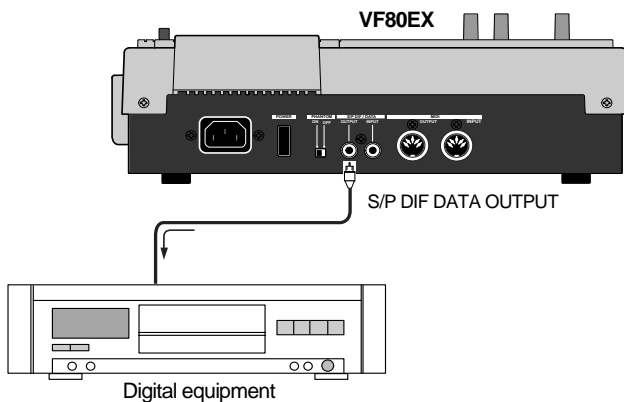

- If your digital recorder only provide the optical digital input jack and does not provide the coaxial jack, use the optional COP-1/96k (optical/coaxial converter).
- Do not connect digital signals for both directions between the VF80EX and the external recorder (i.e. the digital output of the VF80EX to the digital input of the external recorder and the digital output of the external recorder to the digital input of the VF80EX), which may form a digital loop and cause feedback.

Setting the external recorder

- 1 Set the sampling frequency to 44.1 kHz (the same as the VF80EX).
- 2 Set the input source to "digital input" to accept the signal from the VF80EX.
Some machine also needs to select the clock reference to "external" when setting the input source to "digital input". See the operation manual of the machine for the detailed information.

<Note>

If you cannot hear the input signal or you hear digital noise when monitoring the source signal of the external digital recorder, check the connections, cables and settings of both the VF80EX and the external recorder.

- See the operation manual of the external recorder for the detailed information.

Saving data

You can save data via the "Save PGM" menu in the setup mode.

<Details about "Save PGM" menu>

- Output signal options: S/PDIF and IDE (CD-R/RW drive)
- Program options: P01 to P99 (an individual Program)
- Track options:
 - * When using S/PDIF: Tracks 1-8, Tracks 1-16, Tracks 1-24, Tracks 9-16, Tracks 9-24 or Tracks 17-24.
 - * When using IDE (CD-R/RW drive): All tracks (1-24) is selected automatically. (You can select tracks individually when saving by the WAV file format).

- 1 Press the [SETUP] key to enter the setup mode.
The display shows the screen for selecting the setup menu.
- 2 Use the [JOG] dial to select "Save PGM" and press the [ENTER/YES] key.
The display shows the screen for selecting the device to which the data is saved. "IDE" flashes.

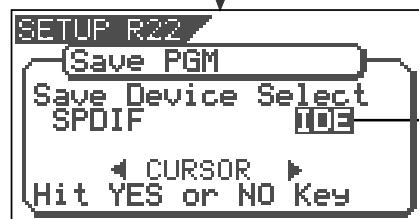
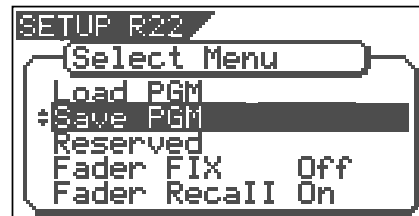

- "IDE" should be selected when saving or loading data via CD-RW/CD-R.

- 3 Use the [JOG] dial or [CURSOR] keys to select "SPDIF" and press the [ENTER/YES] key.
The display shows the screen for selecting the program to be saved.
The program number currently selected flashes, while the data size of the program is shown.
While a program number is flashing, you can select the desired program to be saved.

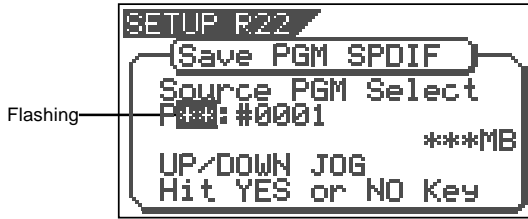

4 Use the [JOG] dial to select the program to be saved and press the [ENTER/YES] key.

The display shows the "Save Length" screen. Initially, the recorded time length of the selected program (ABS 00 to REC END) is shown as the time length of data saving. Normally you do not need to edit the length but you may edit it to the desired value if needed.

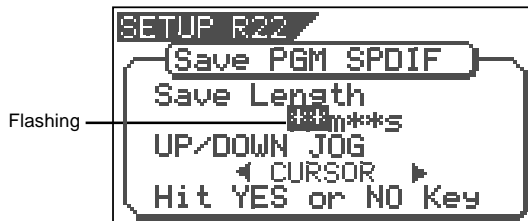

For example, if the actual recorded time is 9 min. 00 sec., you can make the length of the data to be saved shorter or longer than 9 min. 00 sec., as long as the length does not exceed 59 min.59 sec.

The initially displayed value here is the length of the Real track, therefore, as noted earlier, you may edit the value to match the length of the Additional track if it is longer.

To edit the save length

Use the [CURSOR] keys to move the flashing field between "minutes" and "seconds".
Use the [JOG] dial to set the value for the flashing field.

5 Press the [ENTER/YES] key.

The display shows the screen for selecting tracks to be saved.

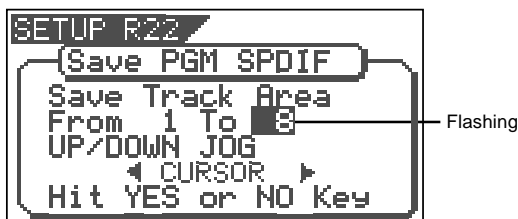

6 Select tracks to be saved.

Use the [CURSOR] keys to move the blinking field between "From" and "To".

Use the [JOG] dial to set the track number for the blinking field.

For the "From" field, you can select from 1, 9 and 17. For the "To" field, you can select a higher value than the "From" field value among 8, 16 and 24.

Accordingly, you can set "Save Track Area" to one of the following.

"From 1 To 8", "From 1 to 16", "From 1 To 24", "From 9 To 16", "From 9 To 24", and "From 17 To 24"

<Note>

When you save tracks including Additional tracks, read <Notes for saving data using the S/PDIF digital signal> on page 107 before executing the save operation.

7 After selecting tracks, press the [ENTER/YES] key again.

The display shows "Rec Start Recorder!" together with the program and tracks to be saved, and "Sure?" flashes. If you are sure to start saving data to the recorder, go on to the next step.



8 After checking all preparations on the external recorder are made, start it recording.

It may be a good idea to put a Start-ID (for DAT) or set a locate memory at the starting position so that you can easily find the position when you load the data later.

9 Press the [ENTER/YES] key immediately after the external recorder starts recording.

The display shows something like the one below. After a few seconds, the unit starts saving the data and "Wait time" starts counting down.

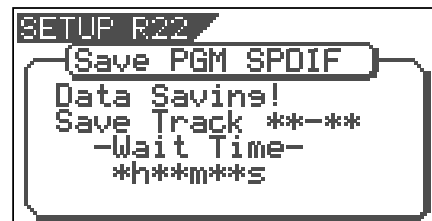

For the first several seconds, the VF80EX transmits the pilot signal that will be a reference for locating the tape position during the load operation, and the actual data saving starts from the position at which "Wait Time" starts counting down.

Data is saved in 2-track unit. When the data saving is completed, "Completed!" appears on the screen and the VF80EX stops.

<Note>

If you interrupts saving before completing, the saved data is invalid.

10 Stop the external recorder.

11 Press the [EXIT/NO] key (or the [STOP] key) repeatedly until exiting the setup mode.

- To cancel each operation or to return to the previous screen before pressing the [ENTER/YES] key, press the [EXIT/NO] key (or the [STOP] key). Each press of the key returns to the previous screen level and finally exits the setup mode.

Loading data using the S/PDIF digital signal

You can load data using the S/PDIF digital signal via the **[S/P DIF DATA INPUT]** (coaxial) jack.

*Use an external recorder that supports 44.1 kHz sampling frequency (the same as the VF80EX).

Connecting to an external recorder

Connect the **[S/P DIF DATA INPUT]** jack to the digital output jack of the external digital recorder.

<Note>

Do not do anything, such as unplug the coaxial cable, that interrupts the digital signal until the loading operation is completed. Otherwise, the unit may generate a noise which damages an external recorder.

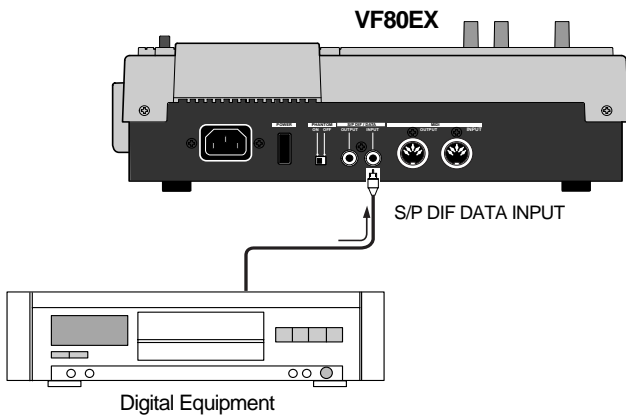

- If your digital recorder only provide the optical digital input jack and does not provide the coaxial jack, use the optional COP-1/96k (optical/coaxial converter).
- Do not connect digital signals for both directions between the VF80EX and the external recorder (i.e. the digital output of the VF80EX to the digital input of the external recorder and the digital output of the external recorder to the digital input of the VF80EX), which may form a digital loop and cause feedback.

Setting the external recorder

1 Make preparations of the external recorder for outputting the digital signal.

2 Locate to the beginning of the pilot signal for the song data.

• See the operation manual of the external recorder for the detailed information.

Loading data

You can load data via the "Load PGM" menu in the setup mode.

<Details about "Load PGM" menu>

- **Input signal options:** S/PDIF and IDE (CD-R/RW drive)
- **Program options:** P01 to P99 (an individual Program)
- **Track options:**
 - * **When using S/PDIF:**
Tracks 1-8, Tracks 1-16, Tracks 1-24, Tracks 9-16, Tracks 9-24 or Tracks 17-24.
 - * **When using IDE (CD-R/RW drive):**
All tracks (1-24) is selected automatically. (You can select tracks individually when saving by the WAV file format).

1 Press the **SETUP** key to enter the setup mode. The display shows the screen for selecting the setup menu.

2 Use the **[JOG]** dial to select "Load PGM" and press the **[ENTER/YES]** key. The display shows the screen for selecting the recorder from which the data is loaded. "IDE" flashes.

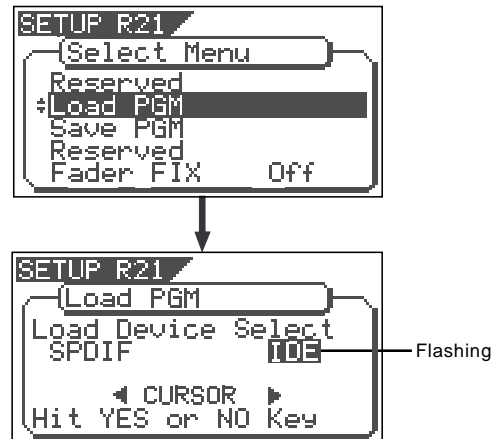

3 Use the **[JOG]** dial or **[CURSOR]** keys to set "Load Device Select" to "SPDIF" and press the **[ENTER/YES]** key.

The display shows the screen for selecting a load destination program to which data is loaded. A program number currently selected blinks, followed by its program name. The data size of the current program is also shown. When a program number is flashing, you can select the desired load destination program.

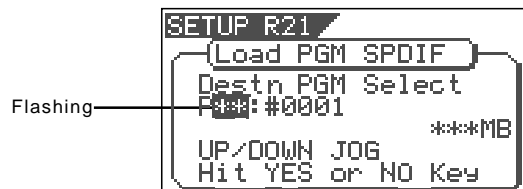

You can select a load destination program from existing programs on the current drive as well as "New PGM". When selecting "New PGM", a new program is created.

- If you load data to a program in which data is already recorded, the newly loaded data overwrites the current data track by track. Consequently, on each overwritten track, the loaded data becomes valid while the current data is erased.

4 Use the [JOG] dial to select the program to which data is loaded and press the [ENTER/YES] key.
The display shows the screen for selecting tracks to be loaded.

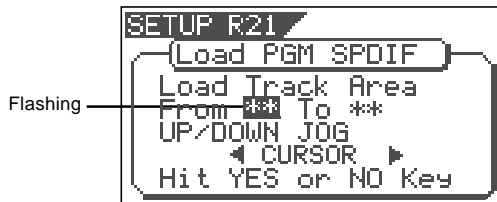

5 Select tracks to be loaded.
Use the [CURSOR] keys to move the flashing field between "From" and "To".
Use the [JOG] dial to set the track number for the flashing field.
For the "From" field, you can select from 1, 9 and 17.
For the "To" field, you can select from 8, 16 and 24.
For example, if you select "From 1 to 24", data for all tracks (1 to 24) will be loaded.

6 After selecting tracks, press the [ENTER/YES] key again.
The display shows something like the one below. A load destination program (existing or new program) to which the data is loaded and tracks to be loaded are shown, while "Sure?" flashes.

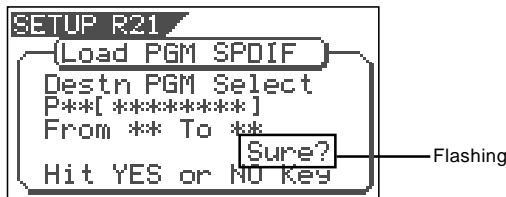

<Note>

In the above step, if the VF80EX does not lock to the digital signal from the external digital recorder, the following warning message appears on the display, showing that the VF80EX does not receive a correct S/PDIF digital signal. So check the cable connection and the digital output setting of the external digital recorder.

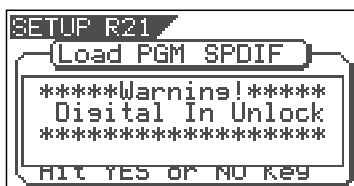

7 When the VF80EX is locking to the digital input signal, press the [ENTER/YES] key.
The display shows "Play Start Player!".

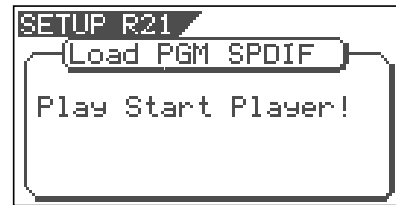

8 Start playback of the external recorder.
After reading the pilot signal recorded when saving the data, the data starts loading automatically.
When starts loading, the display shows something like the one below, in which "Wait time" starts counting down.

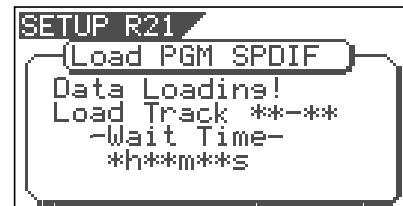

Data is loaded in 2-track unit.
While loading, the [TRACK STATUS/TRACK SEL] keys for channels 1 and 2 flash, while the input levels are displayed by level meters 1 and 2.

When the data loading is completed, "Completed!" appears on the screen.

<Note>

If you quit loading before completing, the loaded data is invalid.

9 Stop the external recorder.

10 Press the [EXIT/NO] key (or the [STOP] key) repeatedly until exiting the setup mode.

- To cancel each operation or to return to the previous screen before pressing the [ENTER/YES] key, press the [EXIT/NO] key (or the [STOP] key). Each press of the key returns to the previous screen level and finally exits the setup mode.

Save/Load using CD-RW/CD-R

By using the built-in CD-R/RW drive (Model CD-1AEX), you can save/load data in the FDMS-3 format or WAV file format, as well as create or load an audio CD (CD-DA).

Please read the notes below first before performing the save/load operation.

Please read this first!

<Care and handling of CD-RW/CD-R discs>

With a CD-R/RW drive, you can use not only CD-RW discs but also CD-R discs. Note that CD-R discs has some restrictions as shown below.

CD-RW disc

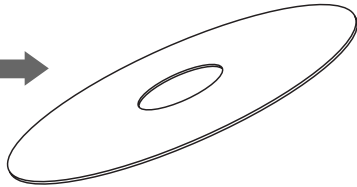

You can save (record) data to a disc as many times required. Note that when saving new data, it is recorded after the previously recorded data is erased. In other words, every time you save new data, all disc data is rewritten. (See "Saving data" described later.)

CD-R disc

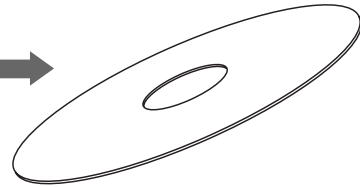

You can save (record) data to a disc only once. You cannot save data to a recorded disc. You can, of course, load data as many times as required.

<Note>

A CD-RW/CD-R disc on which VF80EX data is recorded can only be played by Fostex machines. Do not play it by non-Fostex devices. The drive or system used may be damaged. However, a CD-RW/CD-R disc with audio CD format created by the Fostex machine can be played by general machines such as audio CD players. ***(If an audio CD is made using a CD-RW disc, it can be played back only by a player that supports CD-RW playback. You cannot playback such a disc by a conventional CD player that does not support CD-RW playback.)***

<About data writing and reading speeds for data save/load>

The writing and reading speeds for data save and load of the VF80EX are automatically set as below.

- Writing speed: according to a CD-R/RW drive used, however the maximum speed is 8 times.
- Reading speed: according to a CD-R/RW drive used.

The writing speed depends on a CD-R/RW drive but it is limited to 8 times.

For save/load of the VF80 data, use discs that can be written at 4 times or higher speed. Do not use discs that only can be written at real-time or twice speed.

Save/load of Song Data Using a CD-R/RW drive

The save/load operation using a CD-RW/CD-R disc is performed in the following manners.

• Save

You can only a single selected program data to a disc regardless of the program data amount.

You cannot save more than one program data even if there are enough disc space.

However, you can save a program data to more than one disc if the data amount is larger than a disc space.

As shown on the right, you can save almost all necessary information such as song data of all tracks (real and additional tracks) and mixer scene data.

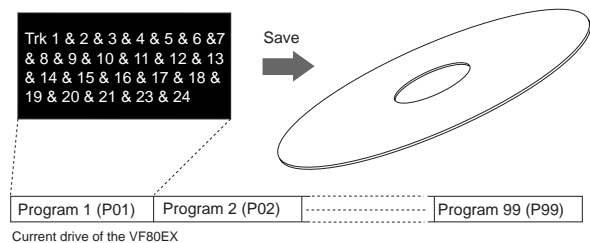

• Load

The data loading using a CD-R/RW drive is taken place after a “**new program**” is created in the current drive (the load destination).

You cannot overwrite an existing program with the loaded data.

The newly created program is numbered the next number to the highest existing program number.

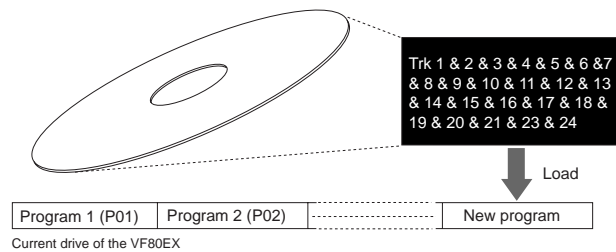

• Creating an audio CD

You can make an audio CD by recording sound data of tracks 1 and 2 between the “**Start point**” and “**End point**” to a CD-RW/CD-R disc. It is also possible to record some mastered materials continuously.

• Loading an audio CD data

You can load a material on a (commercial or created) audio CD to a program of the VF80EX.

Audio data is loaded to a “**new program**” automatically created by the VF80EX, which is the same way as backup data loading. The VF80EX never overwrites the existing program.

Saving data using a CD-R/RW drive (Backup)

The following description is assumed that a non-recorded CD-R/RW disc is used.

<Note>

Do not carry out any VF80EX key operation until the access process to the CD-RW/CD-R disc is completed.

1 After turning on the VF80EX, insert a disc to the CD-R/RW drive.

2 Press the [SETUP] key of the VF80EX to enter the setup mode.

The display shows the screen for selecting the setup menu.

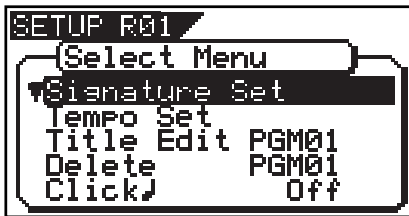

3 Use the [JOG] dial to select (highlight) "Save PGM" and press the [ENTER/YES] key.

The display shows the screen for selecting a save device, where "IDE" is flashing.

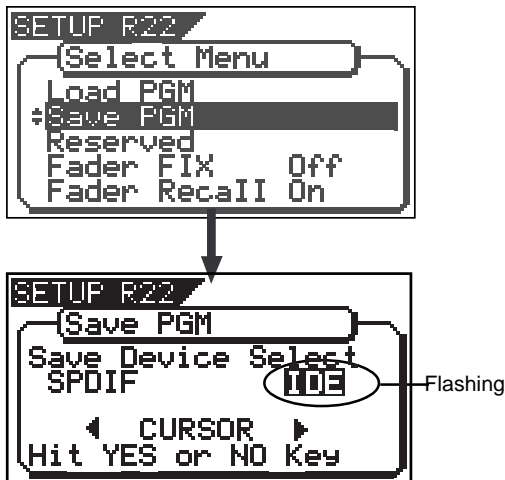

4 While "IDE" is flashing, press the [ENTER/YES] key. After briefly showing the model name of the connected CD-R/RW drive, the display shows the screen for selecting a save mode, where "BkUp" (backup) is flashing.

To save (backup) song data, select "BkUp".

To make an audio CD, select "CD-DA" or "Setup".

This procedure describes how to save song data, so we select "BkUp" here.

See "making an audio CD" described later for details about how to make an audio CD.

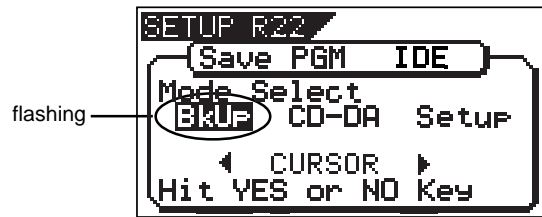

5 While "BkUp" flashing, press the [ENTER/YES] key. The display shows the screen for selecting a backup mode (between FDMS-3 and WAV), where "WAV" is flashing.

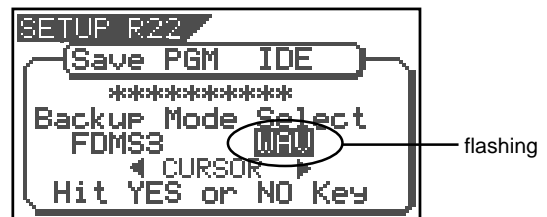

6 Use the [CURSOR <] key to select (highlight) "FDMS3" and press the [ENTER/YES] key.

The display shows the screen for selecting a program to be saved (the program number of the selected program flashes).

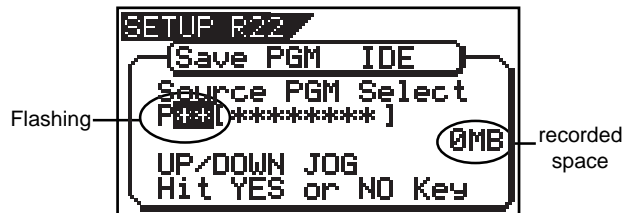

By rotating the [JOG] dial, you can select a desired program number/title from among available programs in the VF80EX current drive. The recorded space of the selected program is also shown.

If you select a program which requires more than one disc for saving, the display shows the required number of discs (see the screen example below).

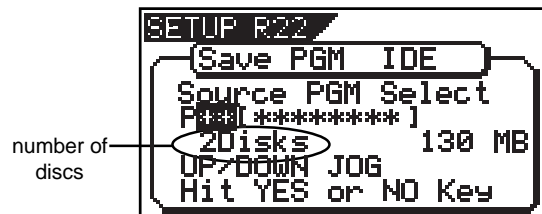

7 After selecting a program, press the [ENTER/YES] key. The display shows the screen as below.

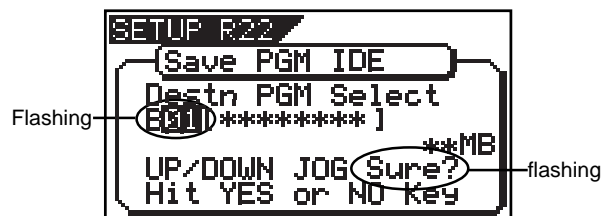

In the example above, the selected program data will be saved to a CD-RW/CD-R disc with the backup number "B01". The program title is copied to the backup title (you can not edit it).

By rotating the [JOG] dial when the above screen is shown, you can also select "Eject", besides "B01".

If you select "Eject" and then press the [ENTER/YES] key, the disc will be ejected.

8 While "B01" is shown, press the [ENTER/YES] key.

The VF80EX starts the save operation. The recorded space shown on the display is counted down while the save operation progresses. It will take some time for saving all data. The following display example shows that the data of the selected program number is being saved to the backup number "B01".

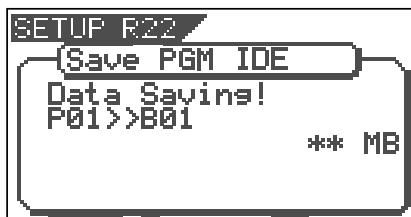

When completing the save operation, "Save Completed!" appears on the display (as shown below) and the VF80EX stops access to the drive, while the disc in the CD-R/RW drive is automatically ejected.

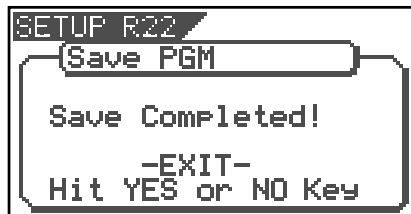

When saving data to more than one disc, the first disc will be ejected when it is full (i.e. there is no more recording space on the disc), while "Insert Disk!" appears on the screen.

After inserting the second disc, the VF80EX automatically resumes the save operation.

After completing the save operation, the final disc is ejected and the above screen appears. (See <Note> below).

<Note>

You cannot abort the save operation before completed. Especially during the save operation to more than one disc, if you happen to press the [EXIT/NO] key while removing or inserting a disc, you have to redo the save operation from the beginning with the first disc.

<Note for saving data to more than one disc>

If you save data to more than one disc, we recommend to put a number on each disc in the saving order (such as DISC-1, DISC-2, etc.) so that you will easily know the order for inserting discs when loading data.

9 Press the [EXIT/NO] key (or the [STOP] key) to exit the Setup mode.

<About save error>

If an error occurs for some reason during the save operation, the error message as below appears.

If it appears, press the [EXIT/NO] key.

The display returns to the previous screen before performing the save operation.

Note that saved data before the error message appears is all invalid.

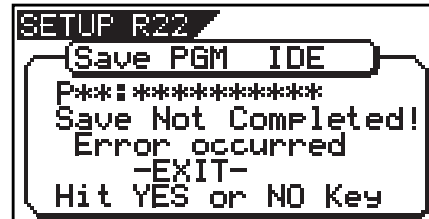

<Note>

If the message above appears while saving data to a CD-R disc, you can no longer use the disc.

<Hint 1>

In the description for saving data above, we assume to use a non-recorded CD-RW/CD-R disc.

If you use a recorded disc (including a disc on which computer data is recorded), also note the following.

By performing step 5 in the save operation procedure shown above ("While "BkUp" is flashing, press the [ENTER/YES] key".) When a recorded disc is inserted, the display shows a warning message, followed by the confirmation screen (where "Sure?" flashes).

With this screen, you can choose whether erasing the recorded data or ejecting the disc.

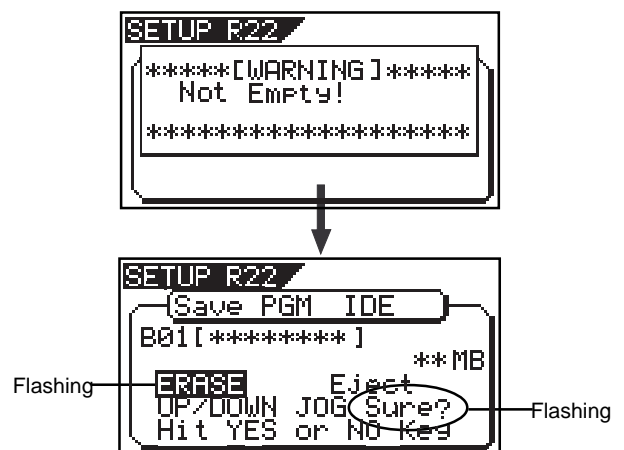

• To erase the existing (recorded) data

Press the [ENTER/YES] key while both "ERASE" and "Sure?" are flashing.

The display shows the screen below and the VF80EX starts erasing the disc.

As the erase process progresses, the number of flashing "*" increases from left to right.

Save/Load of Song data (VF80EX)

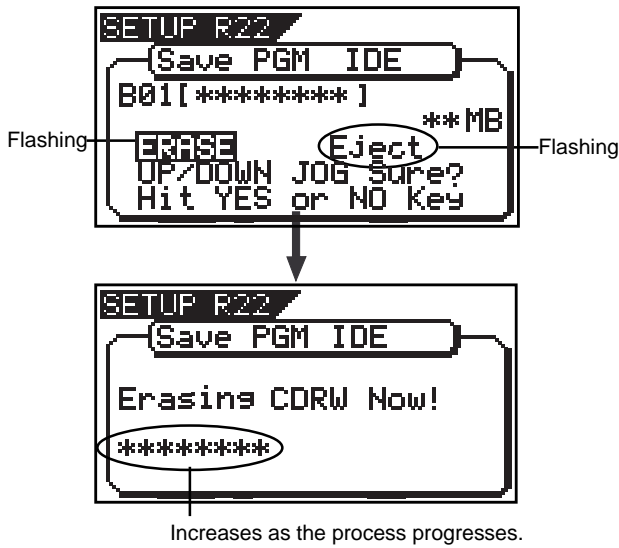

Immediately after completing erasing the disc, the display shows the same screen (for selecting a program to be saved) which appears after step 5 is performed. Hereafter, perform the same procedure as described above.

• To eject the disc

Use the [JOG] dial to highlight “Eject” (flashing) and press the [ENTER/YES] key.
The disc is ejected while the display shows “Insert Disk!”.

By inserting a disc, you can start the save operation again from the beginning.

<Hint 2>

If you try to save data to a recorded CD-R disc, the display shows a warning message saying “Not Writable”, followed by a message saying “Insert Disk” as below.

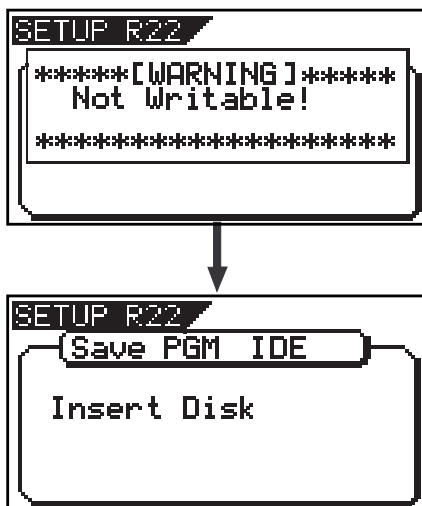

Loading backup data from a CD-R/RW drive

The following description is assumed that you have a CD-RW/CD-R disc which contains saved data.

<Note>

Do not carry out any VF80EX key operation until the access process to the CD-RW/CD-R disc is completed.

- 1 After turning on the VF80EX, insert the disc to the CD-R/RW drive.

<Note>

If you load song data which is saved to more than one disc, set DISC-1 first.
If you set the other disc and go on the following procedure, the VF80EX automatically recognized that the disc order is not correct and the display shows "Wrong Disk", followed by "Illegal No!" momentarily, and the disc is automatically ejected.

- 2 Press the [SETUP] key to enter the setup mode. The display shows the screen for selecting the setup menu.

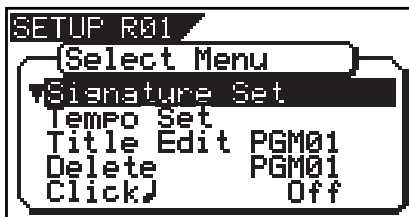

- 3 Use the [JOG] dial to select (highlight) "Load PGM" and press the [ENTER/YES] key. The display shows the screen for selecting a load device, where "IDE" is flashing.

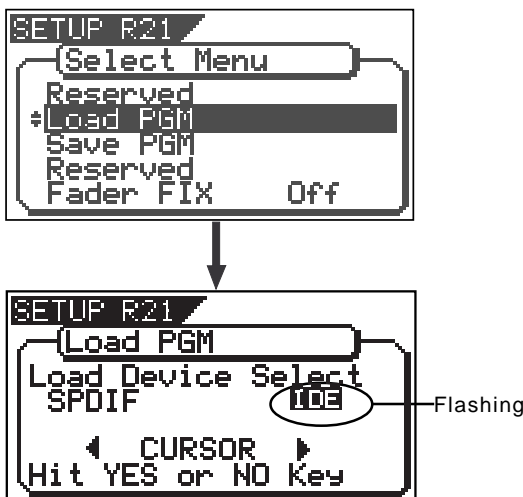

- 4 While "IDE" is flashing, press the [ENTER/YES] key. After briefly showing the model name of the connected CD-R/RW drive, the display shows the screen for selecting a load mode, where "BkUp" (backup) is flashing.

To load song data saved, select "BkUp".

To load a material from an audio CD, select "CD-DA".

This procedure describes how to load song data, so we select "BkUp" here.

See "Loading from an audio CD" described later for details about how to load a material from an audio CD.

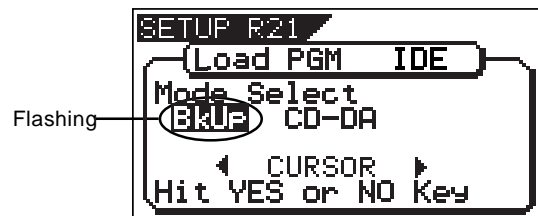

- 5 While "BkUp" is flashing, press the [ENTER/YES] key. The display shows the backup number and title, as well as recorded space.

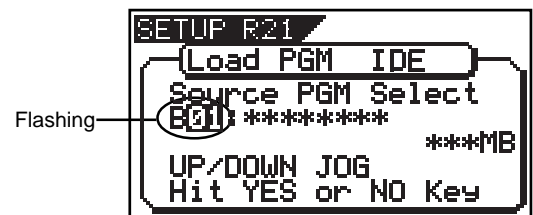

By rotating the [JOG] dial, you can select a desired program number/title from among available programs in the VF80 current drive. You can also select "Eject". If you select "Eject" and press the [ENTER/YES] key, the disc is ejected

When you load song data which is saved to more than one disc, the display also shows the disc number currently set. The example below shows DISC-1 is set.

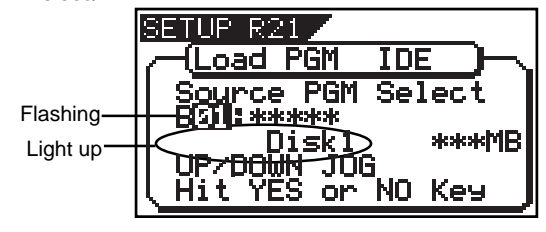

- 6 While the desired backup number/title is shown on the display, press the [ENTER/YES] key. The display shows the screen for creating a new program on the current drive, to which data will be loaded ("New PGM" lights).

Save/Load of Song data (VF80EX)

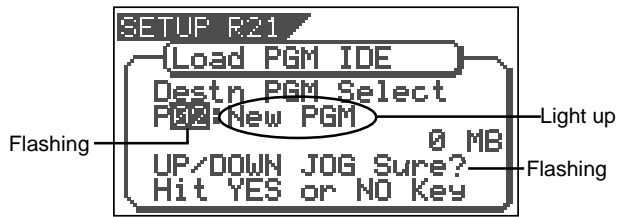

As described earlier, when loading data from a CD-R/RW drive, the VF80EX creates a new program on the current drive, which is the load destination.

Therefore, "New PGM" is shown on the right of the flashing program number.

The program number for the newly created destination program is the next number to the highest existing program number.

For example, if there are 8 existing programs ("P01" through "P08") on the current drive, the newly created program is numbered "P09".

<Note>

If you rotate the [JOG] dial while the above screen ("Destn PGM Select") is shown, you can select an existing program on the current drive as the destination. However, as mentioned earlier, when loading data using CD-R/RW drive you cannot actually load data to the existing program by overwriting the program data.

If you press the [ENTER/YES] key (see the next step) while selecting an existing program as the destination, the display shows "Void!" and the VF80EX ignores the operation.

7 While "New PGM" is shown, press the [ENTER/YES] key.

The VF80EX starts the load operation.

The recorded space shown on the display is counted down while the load operation progresses.

It will take some time for loading all data.

The following display example shows that the data of the backup number "B01" is being loaded to "P08" which is newly created on the current drive.

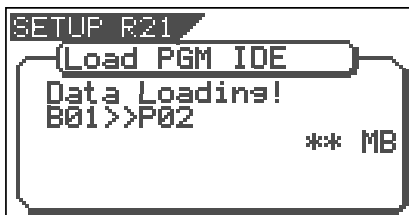

<Display example for loading>

<Note>

If there is not enough available space for loading on the current drive, the display shows "Disk Full!" and the display returns to the previous screen.

When completing the load operation, "Load Completed!" appears on the display (as shown below) and the VF80EX stops access to the drive, while the disc in the CD-R/RW drive is automatically ejected.

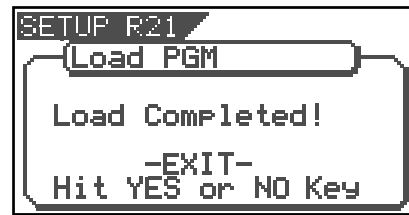

When loading data from more than one disc, the first disc will be ejected immediately after all disc data has been loaded, while "Insert Disk!" appears on the screen. After inserting the second disc, the VF80EX automatically resumes the load operation.

After completing loading all the discs, the above screen appears.

<Note>

You cannot abort the load operation before completed.

8 Press the [EXIT/NO] key (or the [STOP] key) to exit the setup mode.

<About load error>

If an error occur for some reason during the load operation, the error message as below appears.

If it appears, press the [EXIT/NO] key.

The display returns to the previous screen before performing the load operation.

Note that loaded data before the error message appears is all invalid.

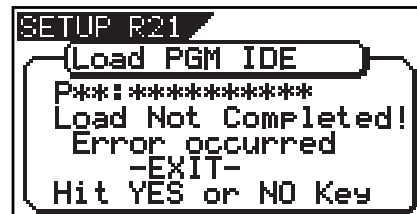

Saving a WAV file

Song data can be saved to or load from a CD-R/CD-RW disc by the FDMS-3 (Fostex Disk Management System-3) format, as well as by the WAV file format. As you can handle song data of the VF80EX with a WAV file, it is possible to directly import/export data from/to a personal computer, to playback/edit a data file with various software applications, and to import a data file edited by a computer to the VF80EX.

<Important notes for using a WAV file>

About directory of a backup disk:

- A WAV file saved is recorded in the root directory (in the first layer) on the backup disk.
- A WAV file that can be loaded must be allocated in the root directory on the backup disk.
A WAV file moved from the root directory to another area such as a folder cannot be recognized by the VF80, which may cause a malfunction.

About file names of WAV files

- A WAV file the VF80EX saves is recorded with a file name "*****#.WAV".
- A WAV file the VF80EX can load must have a file name "*****#.WAV".
The first 6 characters "*****" are the title that is shown in the "Title Edit" screen in the setup mode. These characters can be changed when saving using a WAV file or edited by a computer. The following 2 characters "##" indicate the track number (1 to 24) for the save/load using a WAV file. The last ". WAV" is the file extension indicating that the file format is WAV.
The VF80EX does not recognize other file names than above. See the following description for each operation about details.
By using the specifications above, you can load only the desired tracks of a WAV file or load a track-swapped WAV file. See "Loading a WAV file" described later for details.

You can save a WAV file. The following procedure assumes that the newly CD-RW/CD-R disk is used for backup.

- 1 Press the [SETUP] key to enter the setup mode.**
The display shows the screen for selecting the Setup menu.
- 2 Use the [JOG] dial to select "Save PGM" and press the [ENTER/YES] key.**
The display shows the screen for selecting the device to which the data is saved. "IDE" flashes.

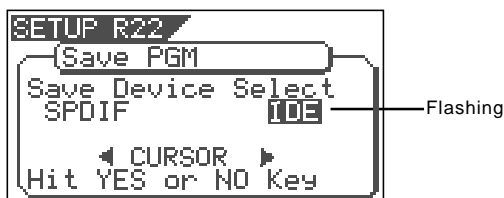

- 3 While "IDE" is flashing, press the [ENTER/YES] key.**
The display shows the screen for selecting the backup mode (FDMS 3 or WAV), where "WAV" flashes.

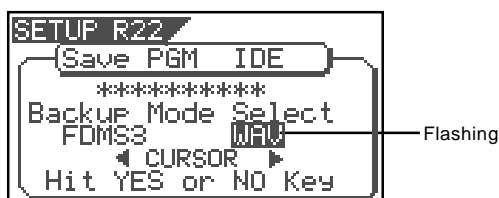

- 4 While "WAV" is flashing, press the [ENTER/YES] key.**
The display shows the screen for selecting On or Off of the Edit Source Export function, where "Off" flashes. You can switch between On and Off by using the [CURSOR] keys.

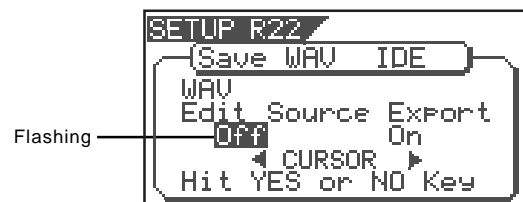

If you save all data from "ABS 0" to "REC END" (in most cases), you do not have to change the setting here.

<About the Edit Source Export function>

The Edit Source Export function allows you to save the desired range of data between the Start and End points which are set when executing the Copy-paste or Move-paste function. Therefore, if you want to save only the specific range of data, you have to register the Start and End points before the save operation. See "Track Editing" in "Recorder Function" for details about how to set the Start and End points.

Save/Load of Song data (VF80EX)

<Note>

If you save all data from "ABS 0" to "REC END", make sure to set the Edit Source Export function to Off.

- 5** While "Off" is blinking, press the [ENTER/YES] key. The display shows the screen for selecting a program to be saved. The program number currently selected flashes, while the data size of the program is shown.

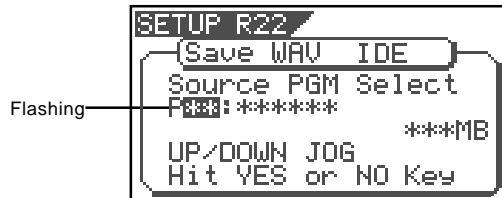

- 6** Use the [JOG] dial to select a program to be saved and press the [ENTER/YES] key.

The display shows the screen for selecting a track to be saved. Initially, "All Track" flashes.

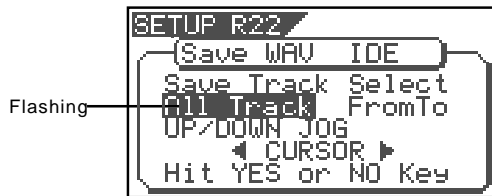

By rotating the [JOG] dial (or press the [CURSOR] </> key), you can select "From ** To **" (where the left field flashes initially) instead of "All Track".

If you save data for all tracks (1 through 24), select "All Track". If you save data for any specific track(s), select "From ** To **" and specify the desired track numbers.



<To specify the desired tracks to "From ** To **">

By rotating the [JOG] dial while the left ("From") field is flashing, you can select the track number from 01 through 24. The number in the right ("To") field automatically follows the number in the left field (i.e. numbers in the left and right fields are always the same). Therefore, if you want to save a single track, you just have to set the right ("From") field and do not have to set the right ("To") field. For example, "From 02 To 02" will save only track 2.

To specify tracks 5 through 12:

- Enter "05" to the left field while the left field is flashing.
- Press the [CURSOR </>] key to make the right field flashing.
- Enter "12". (Note that the number for the right field must be equal to or larger than the left field.)

Finally the screen shows "From 05 to 12" to save tracks 5 through 12.

- 7** After selecting the track(s), press the [ENTER/YES] key.

The display shows the screen for selecting a WAV file on the disk.

If no file is recorded on the disk, "WAV" and "Sure?" flashes. You can select "Eject" by rotating the [JOG] dial. To remove the disk, select "Eject" and press the [ENTER/YES] key.

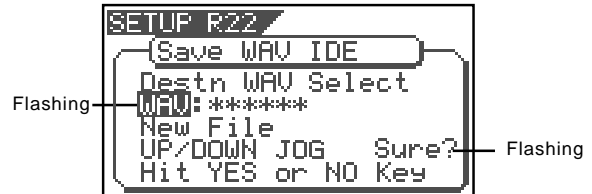

<Hints>

If the backup disk contains any existing program(s) previously saved, the display may show following screens after carrying out the previous step, depending on the available space of the backup disk.

•Showing the title and "New File":

There is enough space for creating a new WAV file in addition to the existing WAV files on the disk.

Pressing the [ENTER/YES] key advances to the next step (for editing the file name).

After completing the save operation, this new WAV file will be added on the disk.

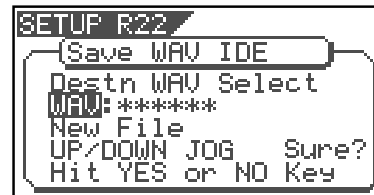

•Showing the title and "New File", and "-****MB" alternately:

The space for adding a new WAV file to the existing WAV files on the disk is ****MB short.

Pressing the [ENTER/YES] key shows "Disk Full!", followed by "Delete All WAV?".

Pressing the [ENTER/YES] key again deletes all the WAV file on the disk and advances to the next step (for editing the file name)

After completing the save operation, only this new WAV file will remain on the disk.

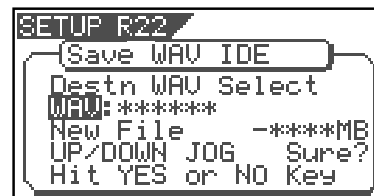

•Showing the title and "****MB":

To get enough space for creating a WAV file, the specified file on the backup disk will be deleted.

By pressing the [ENTER/YES] key, "DEL" appears.

Pressing the [ENTER/YES] key again will delete the specified WAV file on the disk and advances to the next step (for editing the file name).

After completing the save operation, the specified WAV file will be replaced with the new WAV file on the disk.

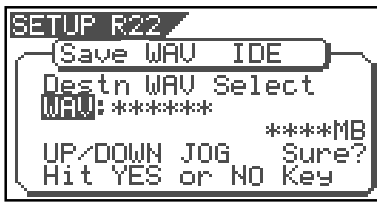

•Showing the title and "-****MB":

Even if the specified file is deleted, the space for creating a new WAV file on the disk is ****MB short. Pressing the [ENTER/YES] key shows "Disk Full!", followed by "Delete All WAV?".

Pressing the [ENTER/YES] key again deletes all the WAV file on the disk and advances to the next step (for editing the file name).

After completing the save operation, only the new WAV file will remain on the disk.

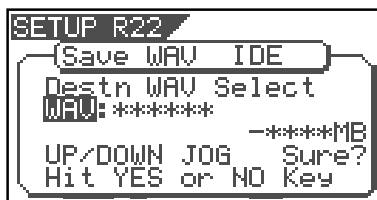

8 After selecting a file, press the [ENTER/YES] key.

The display shows the screen for editing the WAV file.

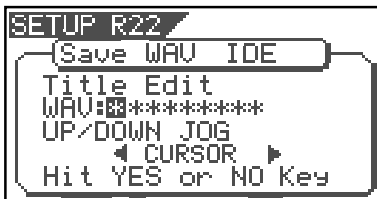

By rotating the [JOG] dial, you can set the desired numeric, symbolic or alphabetical character to the blinking point. You can move the blinking point by using the [CURSOR] keys.

See the following table for the available characters.

- Upper-case alphabetical characters (A to Z)
- Numerals (0 to 9)
- Symbols (! # \$ % & ' () @ ^ _ -)

<Note>

You can use up to 6 characters for a file name. Some characters entered are converted as shown below.

- Upper-case alphabetical characters (A to Z): not converted
- Lower-case alphabetical characters (a to z): converted to the corresponding upper-case
- Numerals (0 to 9): not converted
- Symbols (! # \$ % & ' () @ ^ _ -): not converted
- Other symbols: converted to "_".

9 After entering the file name, press the [ENTER/YES] key.

The save operation is executed and the display shows something like the one as below. As the file save goes on, the remaining data size shown on the screen counts down.

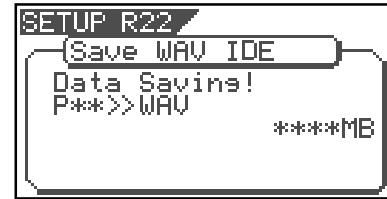

When saving data onto more than one disk, the current disk number is shown on the screen as "Disk*" (where * indicates the number).

Immediately after the data save to each disk is completed, the disk is automatically ejected, and "Insert Disk*" blinks on the screen, prompting you to insert the next disk.

Inserting the next disk resumes the save operation.



After the save operation is completed, "Save Completed!" appears on the screen.

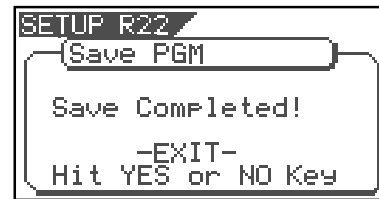

<Hint>

In the save operation which requires more than one backup disk, if you use a backup disk which contains any program(s) saved, the display shows the screen as shown below.

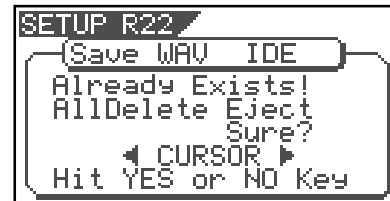

This screen is asking you whether to delete all existing WAV files on the disk or to eject the disk. To delete all the existing files, select "All Delete" and press the [ENTER/YES] key. All existing files are deleted and the disk is ready for saving data.

If you do not want to delete the existing files, select "Eject" and press the [ENTER/YES] key.

The disk is ejected so you can insert another disk. To select between "All Delete" and "Eject", press the [CURSOR] key.

10 Press the [EXIT/NO] key (or the [STOP] key) repeatedly until exiting the setup mode.

<About WAV files saved>

• WAV file structure

A WAV file on the backup disk has 24 files (one file per track) in the root directory of the disk.

The file names are "*****01.WAV" through "*****24.WAV" where "*****" shows the file name specified in step 8 above and each number (01 - 24) shows the corresponding track number.

If a track has no data recorded, the corresponding file with no data is created.

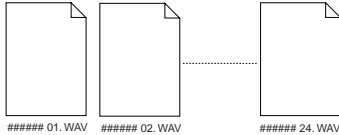

• WAV file structure which is saved over more than one disk

A WAV file is saved in order of track number (from tracks 1 to 24).

During the save operation over more than one backup disk, the VF80EX always calculates the available space of the disk automatically. If the VF80EX knows that the available space gets smaller than the data size of the next track, it will change the disk when the data save of the current track is completed.

• WAV file size

When saving data by the WAV file format to a backup disk, the file size may sometimes increase compared with the data size in the current drive, depending on the recorded data condition such as the start time, end time, the data amount, etc. on each track.

For example, if a track is recorded from ABS:0 (min.) to ABS:1 (min.) and ABS:10 (min.) to ABS 11 (min.), the file on the current drive has a length of 2 minutes, while the WAV file has a length of 11 minutes.

Also as mentioned above, if a track has no data recorded, the corresponding WAV file with no data is created though the size is small.

<Notes>

- If the file name you are going to save duplicates with the existing WAV file name on the backup disk, **"Warning! Already Exist"** is shown on the screen and the save operation will not be executed. In such a case, change the file name according to the procedure above and carry out the save operation again.
- A disk on which you have overwritten data many times may lower the access speed because of the disk fragmentation. Therefore, we suggest that you should use a newly formatted **"clean"** disk for backup.
- If any other file but **"*****#.WAV"** or folder, which cannot be recognized by the VF80EX, is created on the backup disk using a personal computer, the VF80EX cannot calculate the available backup disk space accurately. Accordingly, it may happen that the save operation cannot be completed. You should note this when changing the file name or creating a folder using your computer.

Loading a WAV file

- 1 Press the [SETUP] key to enter the setup mode.**
The display shows the screen for selecting the Setup menu.
- 2 Use the [JOG] dial to select "Load PGM" and press the [ENTER/YES] key.**
The display shows the screen for selecting the device from which the data is loaded. "IDE" flashes.
- 3 While "IDE" is flashing, press the [ENTER/YES] key.**
The display shows the drive name, followed by the screen for selecting the WAV file to be loaded, showing the WAV file name and size.
If no disk is inserted, "No SCSI Disk!" is shown.

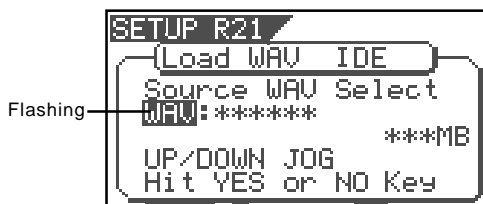

- 4 Use the [JOG] dial to select the desired WAV file to be loaded.**
If more than one WAV file with different file names (the first 6 characters) is saved, you can see each file name (by the first 6 characters) in order when rotating the [JOG] dial. You can also select "Eject" to remove the backup disk.

<Note>
The VF80EX cannot recognize any other file names but "*****#.WAV" and cannot load such disks. A WAV file with a unique name (the first 6 characters) is recognized as an independent backup file and can be selected.

- 5 After selecting the desired WAV file, press the [ENTER/YES] key.**
The display shows the screen for selecting a track to be loaded. "All" flashes initially. Besides "All", you can select any one of tracks (01 through 24) by rotating the [JOG] dial (or press the [CURSOR] </> key).

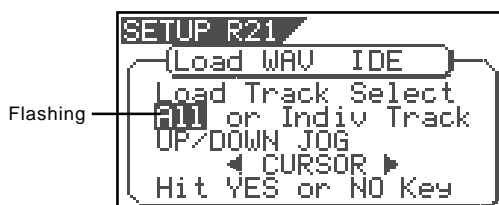

- 6 After selecting the desired track(s), press the [ENTER/YES] key.**
The display shows the screen for selecting the load destination program to which a WAV file is loaded. You can select the program by using the [JOG] dial.

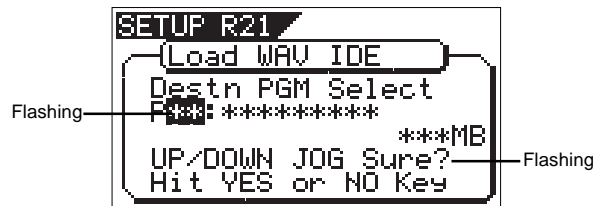

When the screen shows "Title" and "Size", the selected program will be deleted and replaced with the WAV file loaded.

When the screen shows "Title" and "New PGM", the WAV file loaded will create a new program.

<Note>
If the current drive does not have enough available space for loading the WAV file, the size indication on the screen shows a negative value ("-***"). In such a case, select a program that can be replaced with the WAV file loaded without causing the disk space shortage, or delete unnecessary programs by the "Delete PGM" menu in the setup mode.

- 7 After selecting the load destination program, press the [ENTER/YES] key.**

When selecting a new program as the load destination (by selecting an option showing "Title" and "New PGM"), the load operation immediately starts.

When selecting an existing program as the load destination (by selecting an option showing "Title" and "Size"), "Overwrite?" and "Sure?" appear.

Pressing the [ENTER/YES] key will start the load operation.

During the load operation, the screen shows something like the one as below.

As the data load goes on, the remaining data size shown on the screen counts down.

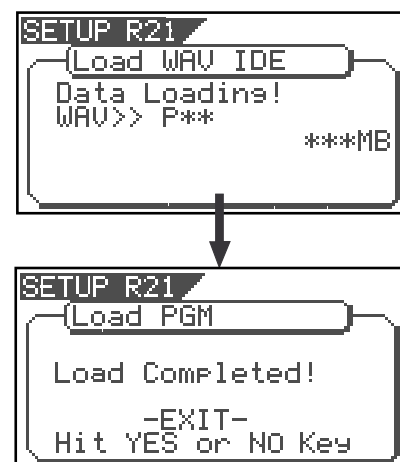

When the load operation is completed, "Load Completed!" appears on the screen.

<Note>
The title of the program to which the WAV file is loaded is replaced with the WAV file name loaded (the first 6 characters).

Save/Load of Song data (VF80EX)

- 8** Press the [EXIT/NO] key (or the [STOP] key) repeatedly until exiting the setup mode.

To go back to the previous step or abort the operation, you can also use the [EXIT/NO] key or the [STOP] key.

<< Special loading method when using a computer >>

< Note >

WAV files which can be saved/loaded by this recorder must have file names written as "*****#.WAV."

Other file names cannot be acknowledged by this recorder.

Unknown file names will not be acknowledged and could cause malfunction. Extreme care should be taken when changing file names and making folders on a computer.

- * The first six letters will be the title shown in the SETUP mode "Title Edit" display.
- * The last two letters "##" represent each track number (1-24) of the WAV file which are to be saved/loaded.
- * The last "WAV" is the extension which indicate that this is a WAV file.
- * File name of the WAV file which is to be saved in the backup disk of this recorder will all be recorded in capital letters. However, in certain computers, this WAV file name will be displayed in small letters.

(* Method to load specific tracks.

The backup disk in which files are saved will contain files from "*****01.WAV" up to "*****24.WAV." Should these files be deleted, moved from the root directory, for example, into a another folder or the file name changed which cannot be acknowledged, this recorder will not recognize this file.

When a backup disk changed in this manner is loaded, only WAV files with file names "*****#.WAV" which are located in an acknowledgeable root directory can be loaded.

For example, if the "zero number of data" made at save is deleted from the backup disk and then load is executed, only WAV files recorded with any other sound can be loaded.

(* When loading WAV files saved in a multiple number of disks, they can be loaded by a special method derived from the above method.

Assume that there is backup disc 1 saved with "*****01.WAV" through "*****12.WAV" and disc 2 saved with "*****13.WAV" through "*****24.WAV."

First, when backup disk 1 is loaded, files in tracks 1-12 will be loaded. At this point, tracks 13-24 will not be loaded and thus be non-recorded. Next, when backup disk 2 is loaded, files in tracks 1-12 remains intact and tracks 13-24 only will be loaded.

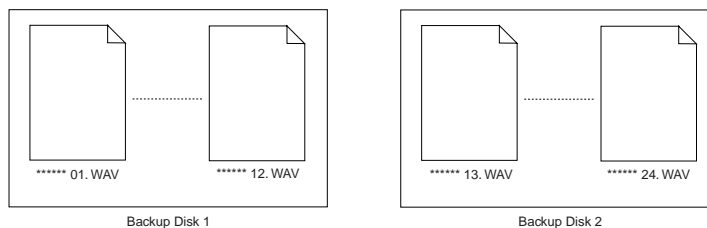

(* Method in loading by changing the track.

If the two letters "##" in file name "*****#.WAV" in the backup disk are changed, it will be possible to load them on this recorder on a track different from that at the initial save. For example, if a WAV file named "ABCDEF01.WAV" on track 1 is changed to "ABCDEF03.WAV" this WAV file will be loaded on track 3.

(* Method in loading by changing the title.

If the 6 letters "*****" in file name "*****#.WAV" in the backup disk are changed, it will be possible to load them on this recorder under a title different from that at the first save. Letters which can be used at changing the file name in a computer are those only indicated below. All of these letters must be one byte size.

Alphabets	: A-Z and a-z
Numerals	: 0-9
Symbols	: !#\$%&'()@'_ =

Making an audio CD

The following procedure describes how to record mastered songs (using the internal mastering function) to a CD-RW/CD-R disc to make an audio CD (CD-DA format).

The “**Save PGM**” menu in the Setup mode, which is used for saving song data, is also used for making an audio CD.

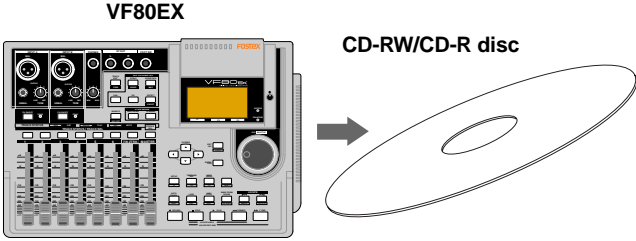

VF80EX → CD-RW/CD-R disc

<Basic information>

When making an audio CD using the VF80EX, internal mastering materials on the current drive are recorded to a CD-RW/CD-R disc (by the CD-DA format).
You can record not only a single song but also multiple songs continuously.

<Note>
If an audio CD is made using a CD-R/RW disc, it can be played back only by a player that supports CD-R/RW playback. You cannot playback such a disc by a conventional CD player that does not support CD-R/RW playback.

In the following operations, we assume that there are one or more programs which are mixed down by the internal mastering mode on the current drive.

<Note>
Key operations of the VF80EX should be done after completing access to a CD-RW/CD-R disc.

- 1** After turning on the power of the VF80EX, load a non-recorded disc to the CD-R/RW drive.
- 2** Press the [SETUP] key to enter the Setup mode.
- 3** Use the [JOG] dial to select (highlight) the “Save PGM” menu and press the [ENTER/YES] key.
The display shows the screen for selecting the device to which the data is saved. “IDE” flashes.

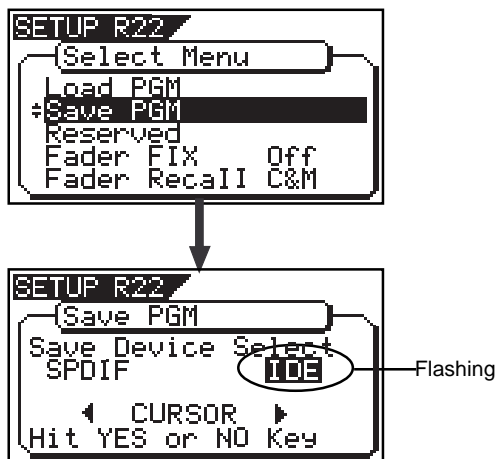

- 4** Press the [ENTER/YES] key while “IDE” flashes.
After showing the model name of the connected CD-R/RW drive, the display shows the screen for selecting the save mode, in which “BkUp” flashes.
To make an audio CD, select “CD-DA”. However, if necessary, you can make the write condition setting by selecting “Setup”. The setting includes copy protection ON/OFF (by default, “OFF”) and mark enabled/disabled (by default, “ON”).
If you do not need to change the default write condition shown above, skip to step 7.

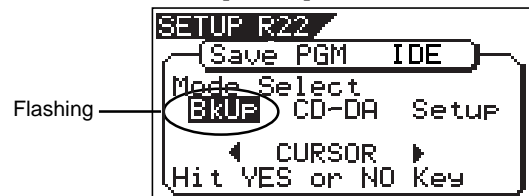

- 5** Use the [JOG] dial (or the [CURSOR] </> key) to select “Setup” and press the [ENTER/YES] key.
The display changes to show the write condition setting screen, in which you can make the copy protection ON/OFF and mark enabled/disabled settings.
See the next page for details.

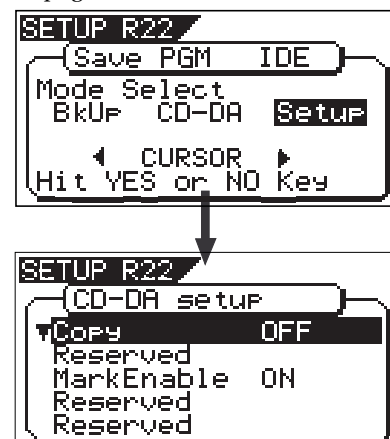

About “Copy protection” setting

You can restrict the disc copy (duplication) capability of an audio CD you are going to make.

ON	A disc you made can be copied to other digital device once.
OFF	A disc you made can be copied to other digital device as many times as required (default).

About “Mark Enable” setting

You can select whether enabling or disabling marks registered between the start and end point. See page 128 for details about “Mark Enable” setting.

ON	Enables marks registered between the start and end point. When making an audio CD, the mastered material is divided into tracks by marks.
OFF	Disables (ignores) marks registered between the start and end point. When making an audio CD, the mastered material is not divided into tracks.

Use the [JOG] dial to select the desired setting item, and press the [ENTER/YES] key. The currently selected option starts flashing. You can now change the setting by using the [JOG] dial to select the desired option (“ON” or “OFF”) and pressing the [ENTER/YES] key to fix the selection.

6 After making the write condition, press the [EXIT/NO] key.

The display returns to the screen for selecting the save mode, in which “CD-DA” now flashes.

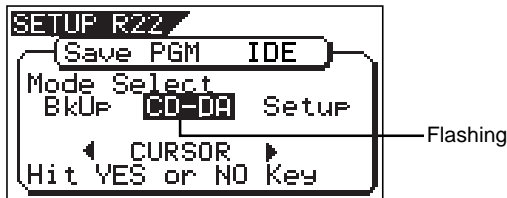

7 While “CD-DA” is flashing, press the [ENTER/YES] key.

After showing “Please Wait!”, the display shows the screen for selecting the program(s) to be record. In the screen, a number such as “01” or “02” shows the track number, while “NON” shows that no program is assigned to the track.

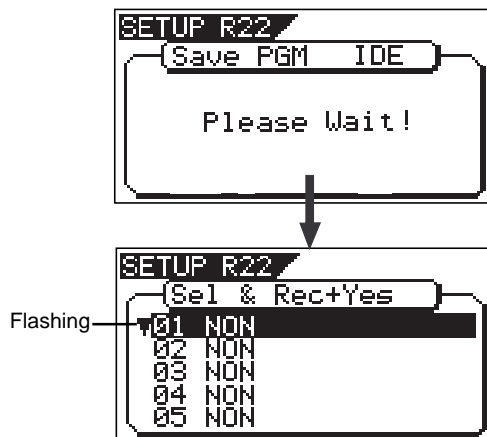

8 Press the [ENTER/YES] key again.

The display shows the screen in which the last program number of the current drive flashes. Its program title and recording time are also shown, while the total time of songs is shown at the top of the screen.

Data between the “Start point” and “End point” is transferred to an audio CD.

Before executing recording, we recommend you to confirm that the actual audio in the program starts just after the “Start point” and ends just before “End point”.

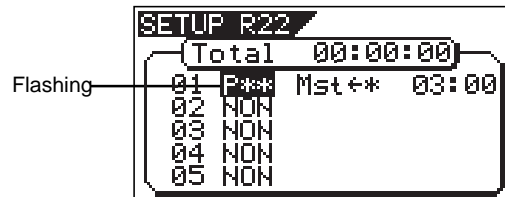

9 Use the [JOG] dial to select a desired program and press the [ENTER/YES] key.

The selected program is set to the first track.

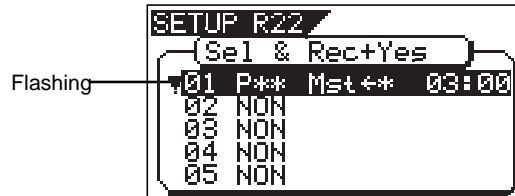

- To record a single song to a CD-RW/CD-R disc, select a program and press the [ENTER/YES] key, and then go to step 10.
- To record more than one song to a CD-RW/CD-R disc, repeat the procedure for selecting a program described above (i.e. use the [JOG] dial to select a program and press the [ENTER/YES] key) until selecting all desired programs, and then go to step 10.

<Note>

If the program time shows “00:00” when selecting a program as the screen example below, the “Start” and “End” points are not correctly set.

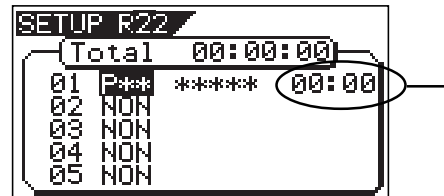

In other words, in the following conditions, the “Start” and “End” points are not regarded as being correctly set.

- “Start point” = “End point”
- “Start point” > “End point”

If you press the [ENTER/YES] key after selecting such a program, the warning message as below appears on the display and you cannot select the program.

“Void In!”, “Void Out!”, or “Void Data!”

<Note>

It is possible to select a program that is not internal mastering if it holds the correct "Start" and "End" points. However, if you record such a program to a CD-RW/CD-R disc with the audio CD format, only track 1 and 2 can be recorded. So, make sure that you select programs properly when making an audio CD.

<Notes for selecting more than one program>

When recording more than one program to a CD-RW/CD-R disc, do not skip any track when assigning programs to tracks.

If you skip any track, you cannot record data to the subsequent tracks. In the following example, track 03 is skipped when assigning programs. So only tracks 01 and 02 will be recorded. Tracks 03 and subsequent tracks can not be recorded.

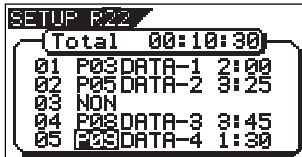

<Note>

When making an audio CD, if you select a program which consumes more disc space than the recordable space of a CD-RW/CD-R disc, "Disk Full!" appears on the display and you cannot select the program.



- 10** After specifying the program(s), press the [ENTER/YES] key while holding down the [RECORD] key.

The VF80EX starts recording to the disc, while the display shows the following screen.

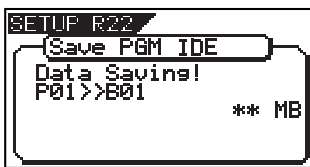

When the recording ends, "Save Completed!" appears on the screen, while the disc is automatically ejected from the CD-R/W drive.

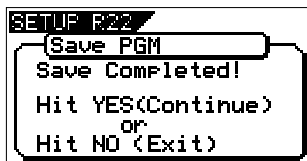

This message asks you whether recording the same material to another disc or finishing recording. To finish recording, press the [EXIT/NO] key. To record the same material to another disc, press the [ENTER/YES] key and go to either step 11 below.

If you press the [ENTER/YES] key, the display changes to show flashing "Insert Disk" for prompting you to insert another disc to the drive.

Depending on the disc you are going to insert, go to either of the steps below.



•When using a blank CD-R/RW disc

- 11** Set a blank CD-R/RW disc to the tray and close the tray.

After reading the disc, the VF80EX starts recording to the disc.



When the recording ends, "Save Completed!" appears on the screen, while the disc is automatically ejected from the CD-R/W drive (as same as step 10 above). If you record the same material to another disc, repeat the steps above.

- 12** When completed, press the [EXIT/NO] key to quit the Setup mode.

•When using a recorded CD-RW disc

- 11** Set a recorded CD-RW disc to the tray and close the tray.

After reading the disc, the display shows a warning message ("Not Empty!"), followed by the screen for selecting whether erasing data or ejecting the disc.

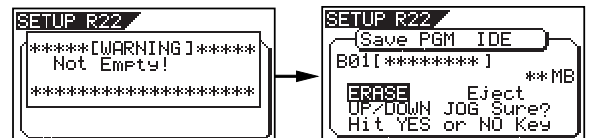

To eject the disc, use the [JOG] dial to select "Eject" and press the [ENTER/YES] key.

To erase data, go to the next step..

- 12** While "ERASE" is highlighted, press the [ENTER/YES] key.

The VF80EX starts erasing the existing data. After erasing all data, recording starts.

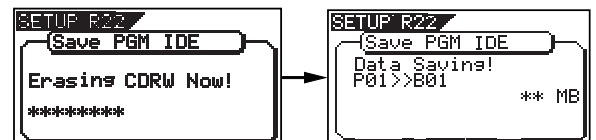

When the recording ends, "Save Completed!" appears on the screen, while the disc is automatically ejected from the CD-R/W drive (as same as step 10 above). If you record the same material to another disc, repeat the steps above.

- 13** When completed, press the [EXIT/NO] key to quit the Setup mode.

<Details of Mark Enable setting>

The Mark Enable setting selects enabling or disabling marks registered between the Start and End points of a material which is internally mastered for creating an audio CD.

Normally, when mastering a song using the internal mastering function, the Start and End points are automatically set (see the figure below). The Start point acts as "mark" at the beginning of the song. By default, the "Mark Enable" is set to "ON" (enabled). Therefore, when recording to a CD-R/RW disc, the VF80EX recognizes the material between the Start and End points as a song (track).

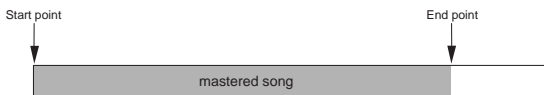

However, if a mastered song has any mark(s) (besides the Start point), set "Mark Enable" to "OFF". Note that the Start point is always recognized as "Mark00" regardless of the "Mark Enable" setting. The figure below shows the example of a mastered song which has marks.

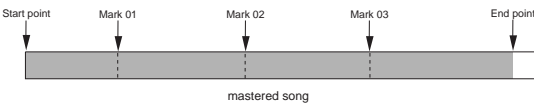

If you record a song which has marks (as above) to a CD-R/RW disc while "Mark Enable" is set to "ON", the song is divided into tracks by marks (see the figure below).

Therefore, when creating an audio CD from a mastered song which has any mark(s), make sure that "Mark Enable" is set to "OFF", in order to ignore the mark(s) except the Start point (Mark00) and prevent the song from being divided into tracks.

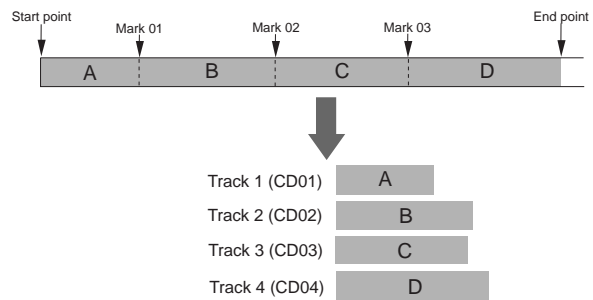

<"Mark Enable" should also be set to "OFF" in such a case!>

Let's assume that there are two programs; program 1 and program 2. The material in program 1 has marks, while the material in program 2 does not (as shown in figure below).

If you make an audio CD from these two materials, burn a disc with "Mark Enable" set to "OFF". In result, you can make an audio CD containing two tracks (ignoring marks on program 1).

If you burn a disc with "Mark Enable" set to "ON", program 1 is divided into four tracks. In result, a CD containing five tracks (four from program 1 and one from program 2) is made.

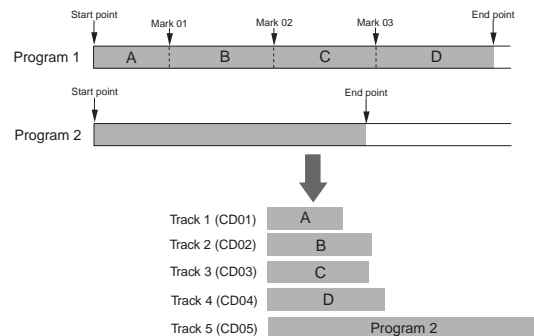
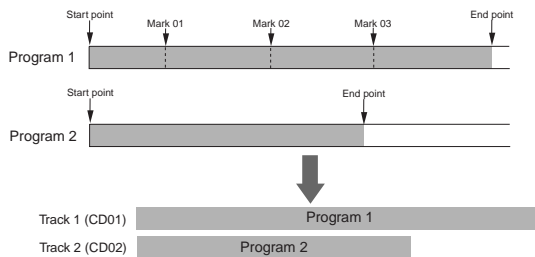

<"Mark Enable" should be set to "ON" in such a case!>

When loading more than one track from an audio CD you made to the VF80EX hard disk, all the tracks are loaded onto a single program (see "Loading from an audio CD" on the next page for details), in which a mark is automatically set to the beginning of each track.

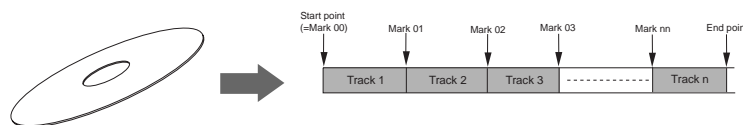

When making an audio CD from a program which has been loaded from an audio CD and contains more than one track, set "Mark Enable" to "ON". This allows making a CD which contains the same number of tracks as the number of tracks loaded from an audio CD.

Loading from an audio CD

You can load a desired song to the VF80EX from an audio CD you created by recording on a CD-RW/CD-R disc. When a desired song is loaded, the VF80EX automatically creates a new program on the current drive, and the song are recorded on tracks 1 and 2 of the program. Loading data from an audio CD is operated via the “Load PGM” menu in the Setup mode, which is the same way as loading backup data.

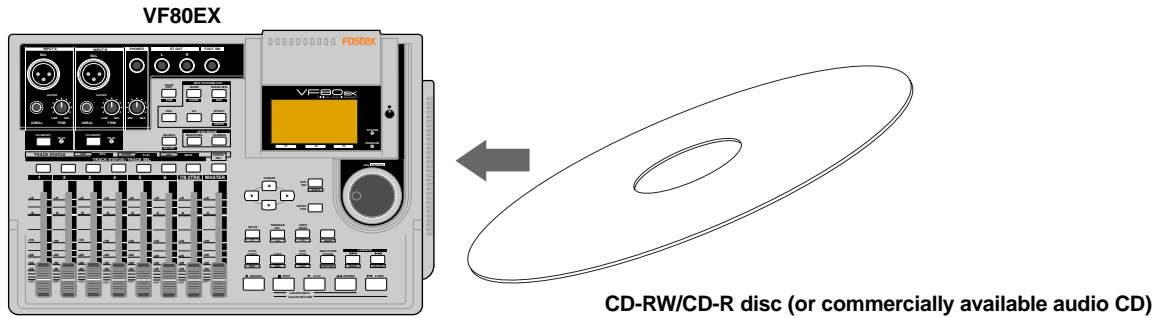

<Important note for copyright>

You can also load a material from a commercially available audio CD in the same manner, however, never use a material for which a copyright is reserved for a commercial purpose. Any unauthorized use will constitute infringement of such copyright and will render the infringer liable to an action at law. Please remember that data included in a commercial audio CD (CD-DA) with copy protection being turned on cannot be loaded into VF80EX.

The following description is assumed that you have an audio CD created by the VF80EX (or a commercially available audio CD).

<Note>

Do not carry out any VF80EX key operation until the access process to the CD-RW/CD-R disc is completed.

- 1** After turning on the power of the VF80EX, load a recorded audio CD disc to the CD-R/RW drive.
- 2** Press the [SETUP] key to enter the Setup mode.
- 3** Use the [JOG] dial to select (highlight) the “Load PGM” menu and press the [ENTER/YES] key. The display shows the screen for selecting the device from which the data is loaded. “IDE” flashes.

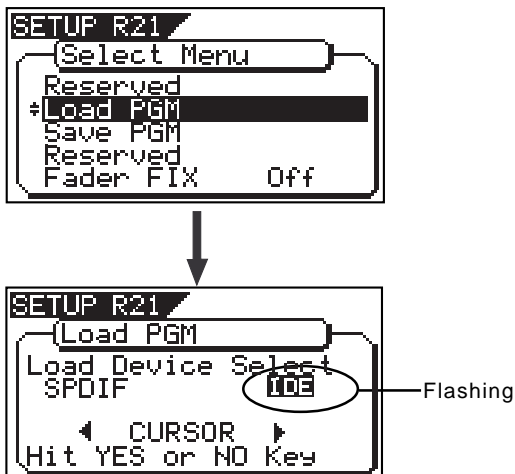

- 4** Press the [ENTER/YES] key while “IDE” flashes. After showing the model name of the connected CD-RW drive, the display shows the screen for selecting the load mode, in which “BkUp” flashes. To carry out loading a song from an audio CD, select “CD-DA”.

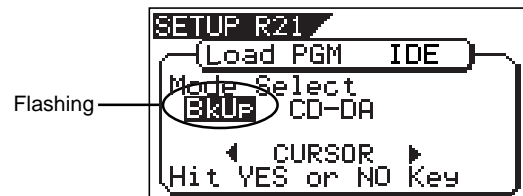

- 5** Use the [JOG] dial (or [CURSOR] </> key) to select (highlight) “CD-DA”, then press the [ENTER/YES] key. A warning message for copyright appears. You can scroll the message to read all message by rotating the [JOG] dial.

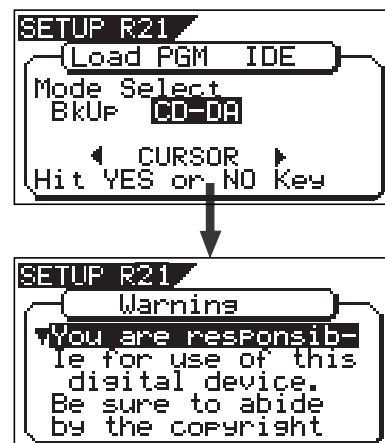

Save/Load of Song data (VF80EX)

<Warning message>

The warning message for copyright shown on the screen is as follows.

Warning!

You are responsible for use of this digital device. Be sure to abide by the copyright conditions of the source material. Press "Enter/Yes" key if you agree with the above.

<Hint>

The warning message above also appears when setting the "Digital In setting" menu to "On". See "Setup mode" on page 130 for details.

<Note>

If you do not agree with the warning message contents, press the [EXIT/NO] key to quit loading. The display briefly shows "Set Disable" and "Can't Loading", then returns to the mode select screen. If you agree with the warning message contents, go to the next step to continue the operation.

6 If you agree to the message contents, press the [ENTER/YES] key.

The display changes to show the screen for selecting the load type, on which "One" flashes. You can select a desired load type from among the following.

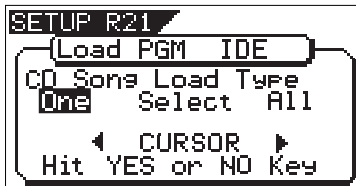

One	You can select one or more tracks to be loaded. Each selected track is individually loaded to a new program automatically created on the current drive.
Select	You can select one or more tracks to be loaded. All the selected tracks are loaded to a new program automatically created on the current drive.
All	All the tracks on an audio CD are loaded to a new program automatically created on the current drive.
* "A new program automatically created on the current drive" has the program number one higher than the current highest program number.	

7 Select the desired "One" or "Select".

Depending on the selected load type, the display shows as below.

•When selecting "One" or "Select":

The left column shows the track numbers (01, 02...) of the audio CD, while "NON" in the second column shows no program is selected.

"**" is shown when more than one track is recorded on the audio CD. It is not shown when only one track is recorded on the audio CD.

To select desired tracks to be loaded, go to step 8.

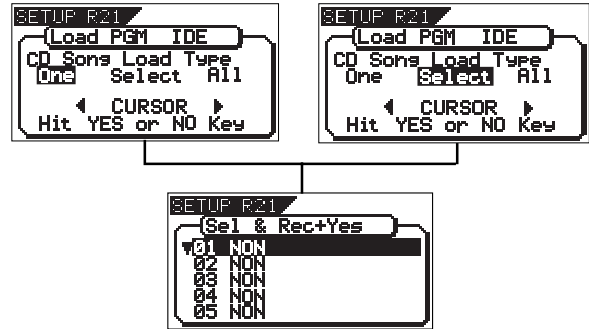

•When selecting "All":

All tracks on the audio CD are selected to be loaded, and the screen as shown below appears. In this screen example, the destination program newly created on the current drive is "P05". Each track time is also shown.

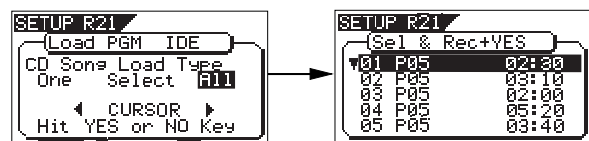

When selecting "All", you can start loading tracks to the current drive by pressing the [ENTER/YES] key while holding down the [RECORD] key.

You can delete an unnecessary track if you want. See <Hint> below about how to do it.

<Hint>

Before executing "All" track loading, you can delete an unnecessary track by the following procedure.

1) While the display shows the screen as above, use the [JOG] dial (or the [CURSOR] keys) to highlight the desired track and press the [ENTER/YES] key.

The destination program number of the selected track starts flashing.

2) Use the [JOG] dial (or the [CURSOR] keys) to select "NON" and press the [ENTER/YES] key.

A track whose destination program number is set to "NON" is not loaded.

8 Use the [JOG] dial (or the [CURSOR] keys) to select (highlight) a desired track to be loaded and press the [ENTER/YES] key.

The load destination program number of the selected track is shown as a flashing display, as well as the track time. In the screen example below, track 1 (01) is selected. The total time is also shown above the track list. (The total time is summed up each time you select another track.)

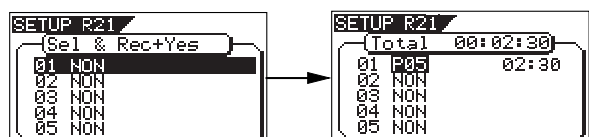

Under this condition, you can choose the option between "Pxx" (program number) and "NON" using the [JOG] dial (or the [CURSOR] keys). To cancel the track selection, choose "NON" and press the [ENTER/YES] key. To set the track to be loaded, go to the next step.

9 Press the [ENTER/YES] key.

The selected track ("01", in this example) is set, while the screen changes as below.

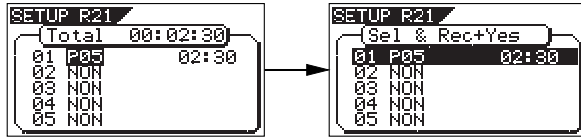

10 Use the [JOG] dial (or the [CURSOR] keys) to select (highlight) another desired track to be loaded and press the [ENTER/YES] key.

In the example below, track 2 (02) is selected (of course, you can select whichever track you want). Depending on the load type ("One" or "Select") selected in step 7) above, the screen shown is slightly different.

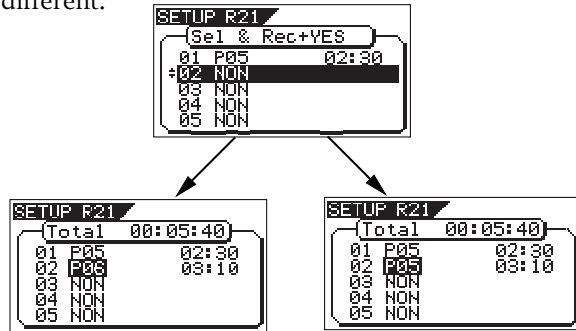

When the load type is "One" When the load type is "Select"

When you set the load type to "One", the load destination program number for the secondly selected track is one higher than that for the firstly selected track. That is, the load destination program number is counted up each time you select a track.

On the contrary, when you set the load type to "Select", the load destination program number for the secondly selected track is same as the firstly selected track. That is, all selected tracks are loaded to the same program.

11 Press the [ENTER/YES] key.

As with the firstly selected track, the secondly selected track ("02", in this example) is set.

12 Operate the same procedure as above for selecting other track.

13 When completing selecting all desired tracks, press the [ENTER/YES] key while holding down the [RECORD] key.

The display shows "Data Loading!" while the remaining data amount (in MB) is counted down. You cannot cancel loading once it starts. Wait for a while until loading is completed. Loading more amount takes more time. When completing loading, "Completed!" is shown, while the audio CD is automatically ejected from the CD-R/RW drive.

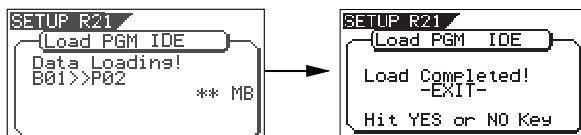

14 Press the [EXIT/NO] key to exit the Setup mode.

<Note for loading>

If you select track 1 (01) and then track 3 (03), as shown in the screen example below, track 3 (03) is loaded to program 6.

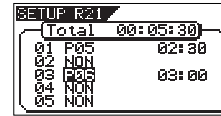

However, if you select track 2 (02) after selecting tracks 1 and 3, track 2 is loaded to program 6 while track 3 is reloaded to program 7.

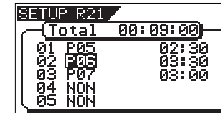

<Hint>

When a CD-RW disc on which any data is recorded is set, if you perform step 7 above (i.e. pressing the [ENTER/YES] key when "CD-DA" is flashing), "Not Empty!" appears on the display, followed by the screen for selecting whether erasing recorded data or ejecting the disc.

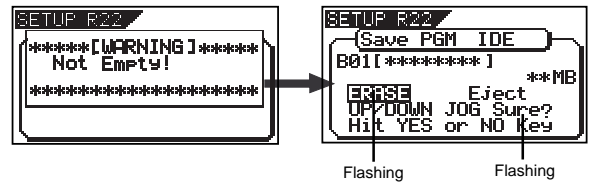

• If you erase recorded data:

Press the [ENTER/YES] key while "ERASE" and "Sure?" are flashing.

After the key press, the display changes as follows and the VF80EX starts erasing the data.

As the erasing process is going on, the number of flashing "*" increases.

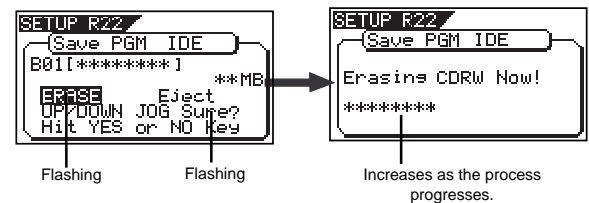

When erasing is completed, the display shows the same screen which appears when pressing the [ENTER/YES] key after selecting "CD-DA" on step 7 above. So follow the same procedure from step 8 on page 123.

• If you eject the disc:

Use the [JOG] dial to make "Eject" flashing and then press the [ENTER/YES] key.

The disc is ejected, while "Insert Disk!" appears on the screen.

When inserting a blank disc, you can go on the next step (see the procedure described above).

<Hint>

To play back a desired loaded track on the current drive, carry out the following operation depending on the load type.

• **To play back a track loaded with the type set to "One":**

1. Select the appropriate program to which the track to be played back is loaded by following the procedure below. (See "Selecting a program" on page 62 for details about how to select a program.)
 - 1-1. Press the [TRACK EDIT/PGM] key while holding down the [SHIFT] key.
 - 1-2. Use the [JOG] dial (or the [CURSOR ▲/▼] keys) to highlight the appropriate program.
 - 1-3. Press the [ENTER/YES] key.
2. Press the [PLAY] key to start playback of the track.

• **To play back tracks loaded with the type set to "Select" or "All":**

1. Select the destination program by following the same procedure as step 1 above.
2. Select a desired track in the program by using the [LOCATE ◀◀] or [LOCATE ▶▶] key while the recorder is stopped or during playback.
 Because all the tracks loaded take part in the same program, you have to select a track within the program.
 The VF80EX automatically set a mark at the beginning of each track loaded with the type set to "Select" or "All", so pressing [LOCATE ◀◀] or [LOCATE ▶▶] key locates to the beginning of the previous or next track, as with a typical CD player on the market (see "Mark function" on page 32 for details).
3. Press the [PLAY] key to start playback of the track.

To check marks, press the [SCENE SEQ./MAP] key while holding down the [SHIFT] key while the recorder is stopped. The display shows the mark map, allowing you to check the mark positions (in the screen example below, the time base is set to "Bar/Beat/Clk").

MARK MAP	BAR	BEAT	CLK
00: -02	BAR	1/00	S00
01: 012	BAR	1/00	Non
02: 020	BAR	4/30	Non
#03: 028	BAR	6/48	Non
04: 022	BAR	2/30	Non
LOCATE	EDIT	DELETE	

SETUP mode

The SETUP mode of the VF80EX offers various menu items including the following types.

- "Setting" menu
- "Check" menu
- "Execution" menu

The "Setting" menu includes 15 menu items as shown in <Table-1> below. These items are set to the default value when shipping the VF80EX from the factory. By editing the setting when necessary, you can change the operational environment of the VF80EX. The "Check" menu provides two items for checking the number of events and current drive information, as shown in <Table-2>. The "Execution" menu includes three items for saving/loading song data and formatting a disk, as shown in <Table-3>. You can access these menu items via the SETUP menu.

This chapter describes details only about "Setting" and "Check" menu items. For details about "Execution" menu items, see the pages shown in <Table-3>.

<Table-1> Setting menu

Contents	Menu item	Default	Page	Commonality
Setting a time signature	Signature Set	001BAR 4/4	134	○
Setting a tempo	Tempo Set	001BAR 1/ 120	136	○
Setting the metronome function	Click J	Off	137	○
Setting MIDI sync output signal	Midi Sync Out	MTC	138	○
Setting an MTC frame rate	Frame Rate	25 frame	138	○
Setting an MTC offset value	Mtc Offset	00h 59m 57s 00f 00sf	139	○
Setting the offset mode	Offset Mode	ABS	139	○
Setting the slave mode	Slave Mode	Off	140	○
Setting the slave type	Slave Type	Vari	140	○
Setting the record protect function	Rec Protect	Off	141	○
Setting digital input	Digital In	Off	142	●
Setting BAR/BEAT resolution mode	J Resolution	Off	142	●
Setting the MIDI device ID number	Device ID	00	143	●
Setting the fader fix mode	Fader Fix	Off	144	○
Setting the fader recall mode	Fader Recall	Off	145	○

○: The setting is applicable program by program, and can be saved or loaded as a song data.

●: The setting is common to all program and cannot be saved or loaded as a song data.

<Table-2> Check menu

Contents	Menu item	Page	Commonality
Check of the event number on the track	Number Of Event	143	-
Check of the current drive information	Drive Information	144	-

<Table-3> "Execution" menu

Contents	Menu item	Page	Commonality
Saving song data to an external device	Load PGM	106	-
Loading song data from an external device	Save PGM	106	-
Formatting an current drive disk	Disk Format	20	-

To enter the SETUP mode

You can enter the SETUP mode only while the VF80EX is stopped.

- 1 While the recorder is stopped, press the [SETUP] key on the panel.

Pressing the [SETUP] key enters the SETUP mode and the display shows the "Select Menu" screen, the top menu of the SETUP mode, for selecting the SETUP menu item. The currently selected menu item is highlighted. The flashing ▼ indicates that invisible menu items exist below.

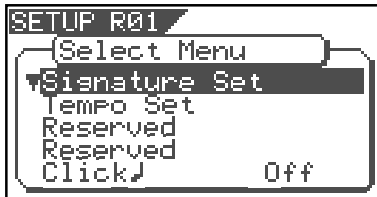

<Note>

The first time the VF80EX enters the SETUP mode after turning on the power, the "Signature Set" menu item is highlighted. From the second time the VF80EX enters the SETUP mode after turning on the power, the menu item previously selected is highlighted.

- 2 Use the [JOG] dial to select a desired menu item and press the [ENTER/YES] key.

You are now ready for the actual setup procedure.

<Important>

- * To exit the SETUP mode or return to the previous screen layer, press the [EXIT/NO] key (or [STOP] key).
- * You can select a desired SETUP menu item using the [CURSOR ▲/▼] keys, as well as the [JOG] dial.

Setting a time signature ["Signature Set"]

Using the "Signature Set" menu item, you can manage time signatures in a song. You can not only specify the time signature at the beginning of a song, but also change the time signature at desired points within a song by inserting "time signature events". For example, you can start a song by 4/4 and change to 2/2 from the third bar. A "tempo map" is created by making time signature and tempo setting. According to a tempo map, the VF80EX can manage a song by BAR/BEAT/CLK time base, as well as can use the metronome function. Also, when the VF80EX feeds MIDI clock and song position pointer to an external sequencer, the time signature and tempo setting must be made.

- Default setting: bar 001, 4/4
- Selectable bar numbers: 001 ~ 999
- Selectable time signature: 1/4, 2/4, 3/4, 4/4, 5/4, 1/8, 3/8, 5/8, 6/8, 7/8, 8/8, DEL
- Maximum setting points: 64
- * The setting is applicable program by program.
- * You can save the setting as a part of the song data.
- * The setting remains effective even after you power off and then on.

- 1 Select a program to which you want to set the time signature.

- 2 On the Select Menu screen of the SETUP mode, select "Signature Set" and press the [ENTER/YES] key.

The display shows the "Signature Set" screen. By default, the screen is as shown below, on which the bar offset is set to "-002BAR", the time signature from the first bar is set to "4/4". Depending on what you want to edit, select the appropriate item using the [JOG] dial. To edit the bar offset, select "-002BAR Offset". To select the time signature of the first bar, select "001BAR 4/4". To set a different signature from a desired bar, select "Insert New Event". To clear all signature/tempo setting, select "All Clear".

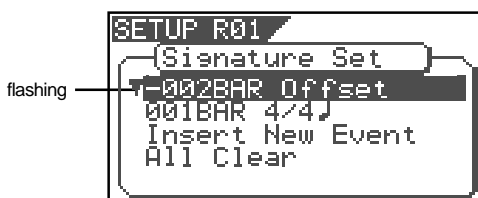

• Changing the time signature in the middle of a song

- 3 On the Signature Set screen, highlight "Insert New Event" and press the [ENTER/YES] key.

"Insert New Event" is replaced with the new time signature setting event. In the bar field of this event, the next bar number to the one on the previous event flashes, while the same time signature as the previous event is shown.

If you carry out the above operation from the default condition, "002BAR 4/4" is shown.

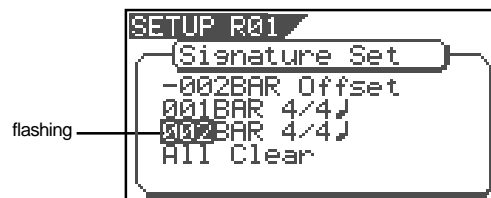

- 4 Use the [JOG] dial to select the desired bar number from which the new time signature is effective, and press the [ENTER/YES] key.

The bar number is set and the time signature field starts flashing.

- 5 Use the [JOG] dial to select the desired time signature, and press the [ENTER/YES] key.

The screen below shows the example of changing the time signature to "3/4" from the third (003) bar.

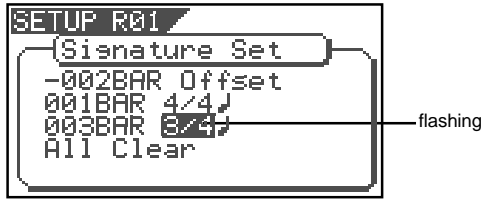

By rotating the [JOG] dial, you can select among from following values for bar and time signature fields.

Bar	from 001 to 999.
Time Signature	1/4, 2/4, 3/4, 4/4, 5/4, 1/8, 3/8, 5/8, 6/8, 7/8, 8/8, or DEL "DEL" is used to deleted time signature data. See "Deleting time signature data" below for details.

- 6** To insert another time signature event, repeat steps 2 through 5.
- 7** When completing time signature setting, press the [EXIT/NO] key (or the [STOP] key) repeatedly until the VF80EX exits the SETUP mode.

• Editing a time signature event

- 1** On the "Signature Set" screen, select the desired event and press the [ENTER/YES] key.
The current time signature value starts flashing.
- 2** Use the [JOG] dial to select the desired signature and press the [ENTER/YES] key.
The setting is now effective.
- 3** After editing time signature event, press the [EXIT/NO] key (or the [STOP] key) repeatedly until the VF80EX exits the SETUP mode.

• Deleting a time signature event

- 1** On the "Signature Set" screen, select the desired event and press the [ENTER/YES] key.
The current time signature value starts flashing.
- 2** Use the [JOG] dial to select "DEL".

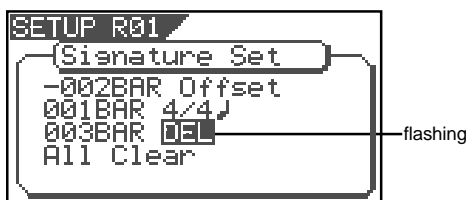

- 3** Press the [ENTER/YES] key.
The selected event is deleted.
- 4** After deleting time signature event, press the [EXIT/NO] key (or the [STOP] key) repeatedly until the VF80EX exits the SETUP mode.

<Note>

You cannot delete the "001BAR" of "001BAR 4/4".

<Note>

After editing or deleting time signature events, if a musical position at which a tempo is specified (see "Setting a tempo" described later) disappears, the associated tempo event is automatically deleted.

• Clearing all time signature/tempo events

<Note>

By carrying out the procedure below, not only the time signature events but also the tempo events are cleared.

- 1** On the "Signature Set" screen, select "All Clear" and press the [ENTER/YES] key.
"SURE?" flashes on the right of "All Clear", asking whether you may clear all signature and tempo data.

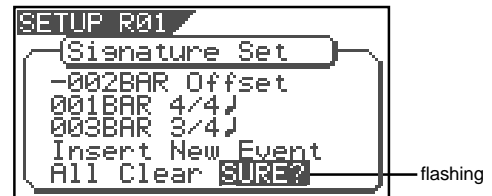

- 2** Press the [ENTER/YES] key.
All time signature events except the initial "001BAR 4/4" event, as well as all tempo events are deleted simultaneously.
- 3** After clearing all events, press the [EXIT/NO] key (or the [STOP] key) repeatedly until the VF80EX exits the SETUP mode.

• Editing the bar offset

- 1** On the "Signature Set" screen, select "-002BAR Offset" and press the [ENTER/YES] key.
"002" starts flashing.

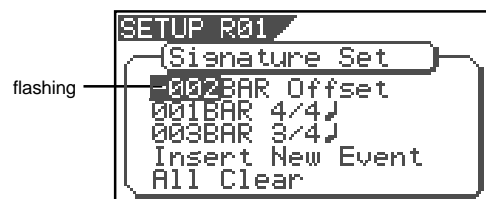

- 2** Use the [JOG] dial to enter the desired offset value and press the [ENTER/YES] key.
You can enter an offset value between -2 and -9.
- 3** After editing the bar offset, press the [EXIT/NO] key (or the [STOP] key) repeatedly until the VF80EX exits the SETUP mode.

Setting a Tempo ["Tempo Set"]

Using the "Tempo Set" menu item, you can manage the tempo in a song. You can not only specify the tempo at the beginning of a song, but also change the tempo at desired points within a song by inserting "tempo events". For example, you can start a song by 120 bpm and change to 150 bpm from the third beat of bar 12. A "tempo map" can be created by making time signature setting (described above) and tempo setting. According to a tempo map, the VF80EX can manage a song by BAR/BEAT/CLK time base, as well as can use the metronome function. Also, when the VF80EX feeds MIDI clock and song position pointer to an external sequencer, the time signature and tempo setting must be made.

<Note>

The tempo set figure setup here is an approximate figure and thus not accurate. Therefore, although the tempo map be matched with a personal computer, they will gradually drift apart. In order to prevent this drift, the personal computer side can be set to either MIDI clock sync or, the MIDI sync output signal temporarily set to "MIDI Clock" the figure reset to make it possible for the computer to read the accurate tempo, and the return it again to MTC sync.

- Default setting: bar 001, beat 1:120
- Selectable bar numbers: according to the time signature setting
- Available beat numbers: according to the time signature setting
- Available tempo: ♩=30~250, or "DEL" ("DEL" is used for deleting a tempo.)
- Maximum setting points : 64
- * The setting is applicable program by program.
- * You can save the setting as a part of the song data.
- * The setting remains effective even after you power off and then on.

1 Select a program to which to you want to set the tempo.

2 On the Select Menu screen of the SETUP mode, select "Tempo Set" and press the [ENTER/YES] key. The display shows the primary "Tempo Set" screen. By default, the screen is as shown below, on which the initial tempo at "bar 001, beat 1" is set to "120". You can set a different tempo from a desired musical point by selecting "Insert New Event" using the [JOG] dial.

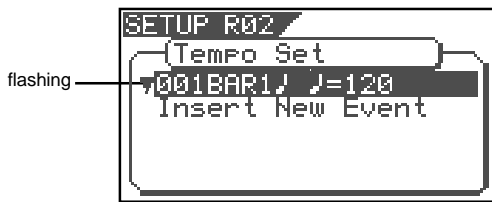

2 Use the [JOG] dial to select the desired bar number from which the new tempo setting is effective, and press the [ENTER/YES] key.

The bar number is set and the beat field (on the left of the first "J") starts flashing. The available bar number depends on the time signature setting described earlier.

3 Use the [JOG] dial to select the desired beat number from which the new tempo setting is effective, and press the [ENTER/YES] key.

The beat number is set and the tempo field (on the right of "J=") starts flashing. The available beat number depends on the time signature setting described earlier.

4 Use the [JOG] dial to select the desired tempo in BPM, and press the [ENTER/YES] key.

You can enter a desired value between 30 and 250. Pressing the [ENTER/YES] key fixes the entered value and the display returns to the primary Tempo Set screen.

5 To insert another tempo event, repeat steps 1 through 4.

6 When completing time signature setting, press the [EXIT/NO] key (or the [STOP] key) repeatedly until the VF80EX exits the SETUP mode.

Let's explain how to make tempo setting for the music example shown below, which has two time signature events; "001BAR 4/4 ♩" and "005BAR 3/4 ♩".

• Changing the tempo in the middle of a song

1 On the primary "Tempo Set" screen, highlight "Insert New Event" and press the [ENTER/YES] key.

On the screen, "Insert New Event" is replaced with the new tempo setting event. In the bar field of this event, the next bar number to the one on the previous event flashes, while the same tempo as the previous event is shown. If you carry out the above operation from the default condition, "002BAR1 ♩=120" is shown.

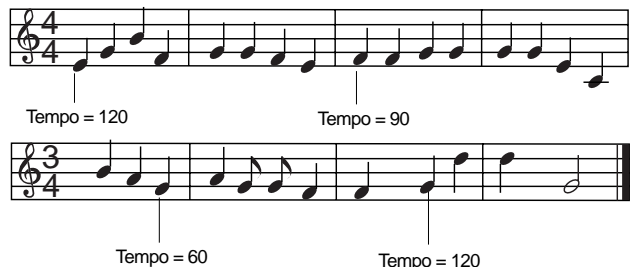
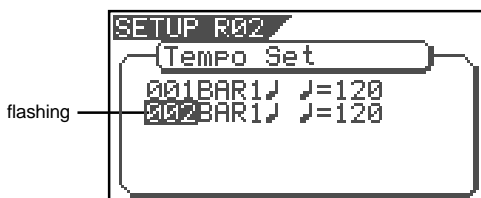

Tempo Map	
Time signature setting	Tempo setting
001 BAR 4/4 ♩	001 BAR 1 ♩ = 120 003 BAR 1 ♩ = 90
005 BAR 3/4 ♩	005 BAR 3 ♩ = 60 007 BAR 2 ♩ = 120

• Editing a tempo event

- 1 On the primary "Tempo Set" screen, select the desired event and press the [ENTER/YES] key.
The current tempo value starts flashing.
- 2 Use the [JOG] dial to enter the desired tempo and press the [ENTER/YES] key.
The setting is now effective.
- 3 After editing tempo event, press the [EXIT/NO] key (or the [STOP] key) repeatedly until the VF80EX exits the SETUP mode.

• Deleting a tempo event

- 1 On the primary "Tempo Set" screen, select the desired event and press the [ENTER/YES] key.
The current time signature value starts flashing.



- 2 Use the [CURSOR ►] key to select "DEL", and press the [ENTER/YES] key.
The selected tempo map will be erased.
- 3 After deleting tempo event, press the [EXIT/NO] key (or the [STOP] key) repeatedly until the VF80EX exits the SETUP mode.

<Note>

You cannot delete the "001BAR 1 J=120."

Setting the Metronome function ["Click J"]

Using the "Click J" menu item, you can select whether or not feeding the metronome click according to the tempo map during playback or recording. By setting this item to "On", you can play your instrument and make recording while listening to the metronome.

<Note>

Metronome sound will be output from track 6.

For this reason, when the metronome function is activated, a new sound source cannot be recorded on the track to which the metronome sound is to be output or sound recorded on this track cannot be played back. If the metronome function is not to be used, be sure to reset it to "Off."

- Default: Off
- Available options: Off and On
- * The setting is applicable program by program.
- * You can save the setting as a part of the song data.
- * The setting remains effective even after you power off and then on.

- 1 On the Select Menu screen of the SETUP mode, select "Click J" and press the [ENTER/YES] key.
The current option (by default, "Off") starts flashing.



- 2 Use the [JOG] dial to select "On" or "Off" and press the [ENTER/YES] key.
By selecting "On", track 6 can output the metronome click.

On	Metronome sound will be output from track 6.
Off (default)	Metronome sound will not be output.

- 3 Press the [EXIT/NO] key (or the [STOP] key) to exit the SETUP mode.

Setting MIDI sync signal output signal ["Midi Sync Out"]

Using the "Midi Sync Out" menu item, you can select the type of a MIDI sync signal message sent to an external MIDI device from the MIDI OUT connector on the VF80EX rear panel.

You can select between MIDI clock & song position pointer and MTC (MIDI timecode). Depending on the device connected to the VF80EX, select the appropriate option.

When selecting MIDI clock & song position pointer, you must make the "Time signature" and "Tempo" settings described earlier. When selecting MTC (MIDI timecode), you must make "MTC frame rate", "MTC offset" and "MTC offset mode" settings described later.

- Default: Clk
- Available options: Clk (MIDI clock & song position)
MTC (MIDI timecode)
Off (No output)
- * The setting is applicable program by program.
- * You can save the setting as a part of the song data.
- * The setting remains effective even after you power off and then on.

2 Use the [JOG] dial to select the desired option and press the [ENTER/YES] key.

CLK (default)	Outputs a MIDI clock & song position pointer message.
Mtc	Outputs a MIDI time code message.
Off	No MIDI sync signal is output.

1 On the Select Menu screen of the SETUP mode, select "Midi Sync Out" and press the [ENTER/YES] key. The current option (by default, "CLK") starts flashing.

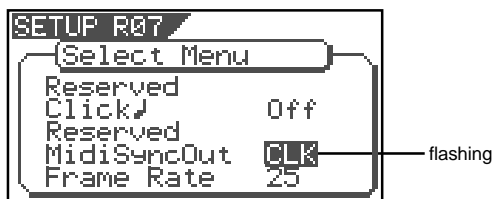

3 Press the [EXIT/NO] key (or the [STOP] key) to exit the SETUP mode.

Setting an MTC frame rate ["Frame Rate"]

Using the "Frame Rate" menu item, you can select the frame rate of MTC sent to an external MIDI device from the MIDI OUT connector of the VF80EX.

When you make the "Midi Sync Out" setting to "MTC", you must set the frame rate appropriately to match the frame rate of an external MIDI device (such as a sequencer, etc.).

- Default: 25 (frames)
- Available options: 24, 25, 30df, 30nd, 29.97df, 29.97nd
- * The setting is applicable program by program.
- * You can save the setting as a part of the song data.
- * The setting remains effective even after you power off and then on.

2 Use the [JOG] dial to select the desired frame rate and press the [ENTER/YES] key. The selected frame rate is set.

3 Press the [EXIT/NO] key (or the [STOP] key) to exit the SETUP mode.

1 On the Select Menu screen of the SETUP mode, select "Frame Rate" and press the [ENTER/YES] key. The current option (by default, "25") starts flashing.

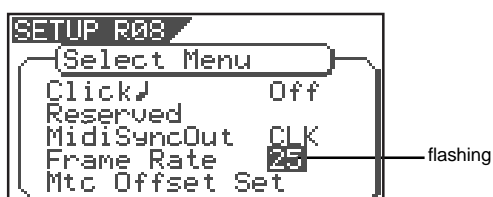

<Note>

In the MTC specification, 29.97nd and 29.97df are not available.

We recommend to use 30 or 30df except when you have to synchronize the VF80EX with NTSC video.

Setting an MTC offset value ["Mtc Offset Set"]

Using the "Mtc Offset Set" menu item, you can set the offset between the internal ABS time and the output MTC. If you set "Midi Sync Out" to "MTC", you must make MTC offset setting. The default offset is "00H59M57S00F00SF", which means "00H59M57S00F00SF" of MTC is output at the ABS0 ("00M00S00F00SF") position. By setting the MTC offset mode (described below) appropriately, you can also set the offset between the musical start point (at "bar 1/beat 1/clock 00") and the output MTC.

- Default: 00H 59M 57S 00F 00SF
- Available options: 00H 59M 57S 00F 00SF to 23H 59M 59S 29F 99SF
- * The setting is applicable program by program.
- * You can save the setting as a part of the song data.
- * The setting remains effective even after you power off and then on.

<Note>

If you set the MTC offset mode to "ABS" (see below) and wish to start a song from "1H 00M 00S 00F" of MTC, the default setting allows you to have three second preroll time.

- 1 On the Select Menu screen of the SETUP mode, select "Mtc Offset Set" and press the [ENTER/YES] key.**
The display shows the "Mtc Offset Set" screen, on which the current offset is shown.
By default, "00H 59M 57S 00F 00SF" is shown, where "57" is flashing, showing that this field can be edited.

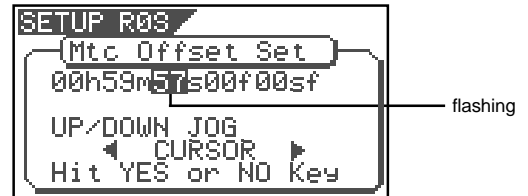

- 2 Use the [CURSOR] keys to select the editing point and use the [JOG] dial to select the desired value.**
- 3 After setting all fields, press the [ENTER/YES] key.**
The entered offset value is set.
- 4 Press the [EXIT/NO] key (or the [STOP] key) to exit the SETUP mode.**

Setting an MTC Offset mode ["Offset Mode"]

Using the "Mtc Offset Mode" menu item, you can select whether the MTC time set by "MTC offset" is output at the ABS0 position (00H 00M 00S 00F 00SF) or the musical starting position ("001BAR 1J 00CLK") on the tempo map.

<Notes>

- If you set the MTC offset mode to "ABS" and wish to start a song from the MTC "1H 00M 00S 00F" position, we recommend to have 3-second preroll by setting the MTC offset to "00H 59M 57S 00F".
If you set the MTC offset mode to "BAR J", a 2-bar preroll is automatically set, therefore, you should set the MTC offset to zero ("00H 00M 00S 00F").
- If you set the MTC offset mode to "BAR J" and run the VF80EX in sync with a sequencer software on your personal computer via MTC, the tempo may be gradually shifted though the same tempo map is used. This is because the speed of the VF80EX and your personal computer may not be exactly the same.
Some sequencer software can read the tempo output from the VF80EX correctly, therefore, we recommend to adjust the tempo of your personal computer to the tempo of the VF80EX.
Note that, if your personal computer runs in sync with a MIDI clock message instead of an MTC message, there will be no problem.

- Default: ABS
- Available offset modes: ABS (00h 00m 00s 00f) or "BAR J (001 bar 1J)
- * The setting is applicable program by program.
- * You can save the setting as a part of the song data.
- * The setting remains effective even after you power off and then on.

- 1 On the Select Menu screen of the SETUP mode, select "Offset Mode" and press the [ENTER/YES] key.**
The currently selected offset mode starts flashing (by default, "ABS" is selected).

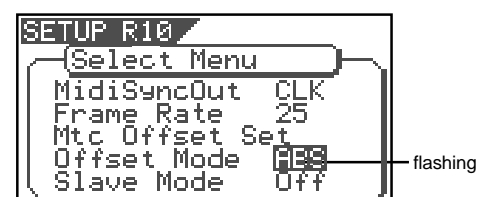

SETUP mode (VF80EX)

- 2** Use the [JOG] dial to select the desired offset mode and press the [ENTER/YES] key.

The selected offset mode will be set.

[ABS] (default)	The MTC offset value you set is output at the ABS 0 (00h 00m 00s 00f) position.
[BAR]]	The MTC offset time is output at the musical starting position (001bar 1beat 00clk) on the Tempo Map.

- 3** Press the [EXIT/NO] key (or the [STOP] key) repeatedly until the VF80EX exits the SETUP mode.

Setting the Slave mode ["Slave Mode"]

Using the "Slave Mode" menu item, you can switch on or off the slave mode.

When switching the slave mode "On", the VF80EX can run in sync with an external device via an MTC.

To run in sync with an external device, you also must select the external sync signal by the "Slave Type" menu item.

- Default: Off
- Available options: On or Off
- * The setting is applicable program by program.
- * You can save the setting as a part of the song data.
- * The setting remains effective even after you power off and then on.

- 1** On the Select Menu screen of the SETUP mode, select "Slave Mode" and press the [ENTER/YES] key.

The currently selected slave mode starts flashing (by default, "Off" is selected).

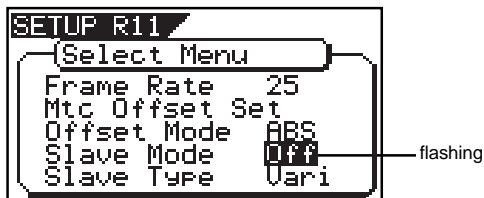

- 2** Use the [JOG] dial to select the desired slave mode ("On" or "Off") and press the [ENTER/YES] key.

- 3** Press the [EXIT/NO] key (or the [STOP] key) repeatedly until the VF80EX exits the SETUP mode.

If you select "On" in step 2, "SLAVE" flashes on the Normal screen. While the VF80EX is locked to an external master, "SLAVE" lights steadily.

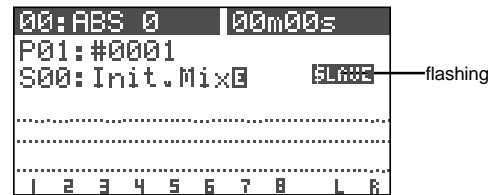

Setting the Slave type ["Slave Type"]

Using the "Slave Type" menu item, you can select the slave type when the VF80EX runs as a slave of an external master.

- Default: Vari
- Available options: Vari, Free, SPDIF
- * The setting is applicable program by program.
- * You can save the setting as a part of the song data.
- * The setting remains effective even after you power off and then on.

<Notes>

- Regardless of slave type selection, the VF80EX needs to receive an MTC from an external device.
- The rebase window of the VF80EX is fixed to 10 frames. This means that, when the slave (VF80EX) timecode shifts off the master more than 10 frames, the VF80EX judges that the chase-lock is not achieved and rebases the master. While rebasing the master, audio is muted. Note that if the timecode difference between the slave and master is within 10 frames, the VF80EX accepts it and does not rebase the master.
- The digital signal selected when the slave mode is set to "On" is used for the external synchronization. This is different from the digital signal selection for digital audio recording (see "Digital input setting" described later).

- 1 On the Select Menu screen of the SETUP mode, select "Slave Type" and press the [ENTER/YES] key. The currently selected slave type starts flashing (by default, "Vari" is selected).

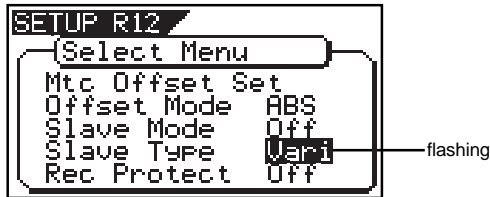

- 2 Use the [JOG] dial to select the desired slave type and press the [ENTER/YES] key. The selected slave type is set.

Free	After the chase-lock is achieved, the VF80EX switches to run freely according to the internal clock or the clock received from the digital input. It does not chase the master even if the VF80EX timecode shifts off the master timecode.
Vari (default)	After the chase-lock is achieved, the VF80EX always check the timecode difference and runs in the vari-speed mode to chase the master. However, when the digital input is selected, it runs the same as "Free" described above.
SPDIF	After the chase-lock is achieved, the VF80EX runs freely according to the S/PDIF clock when an S/PDIF digital signal is fed from the master. However, when the digital input is selected, it runs according to the digital input clock.

- 3 Press the [EXIT/NO] key (or the [STOP] key) repeatedly until the VF80EX exits the SETUP mode.

Setting the Recording protect function ["Rec Protect"]

Using the "Rec Protect" menu item, you can select the recording protection "On" or "Off". This is similar to the "recording protection tabs" of a cassette tape. When it is set to "On", you cannot make recording, paste or erase data, etc.

- Default: Off
- Available options: On, Off
- * The setting is applicable program by program.
- * You can save the setting as a part of the song data.
- * The setting remains effective even after you power off and then on.

<Note>

If you try to make recording, paste or erase data while [Rec Protect] is set to "On", [Protected] is shown on the display for a second and the operation is canceled. To make the operation possible, set [Rec Protect] to "Off".

- 1 On the Select Menu screen of the SETUP mode, select "Rec Protect" and press the [ENTER/YES] key. The current setting starts flashing (by default, "Off" is selected).

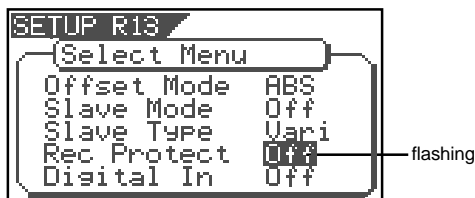

- 2 Use the [JOG] dial to select "On" or "Off", and press the [ENTER/YES] key. The selection is set.

Off (default)	You can make recording, paste or erase data, etc.
On	You cannot make recording, paste or erase data, etc.

- 3 Press the [EXIT/NO] key (or the [STOP] key) repeatedly until the VF80EX exits the SETUP mode.

Setting Digital input ["Digital In"]

Using the [Digital In] menu item, you can select whether or not assigning the S/PDIF digital signal received from the S/P DIF DATA INPUT (COAXIAL) connector to tracks 7 and 8.

By setting this item to "On", you can record an S/P DIF signal from an external digital device (such as a CD, MD or DAT player) to tracks 7 and 8 of the VF80EX.

- Default: Off
- Available options: On, Off
- * This setting is common to all programs on the same disc.
- * You cannot save the setting as a part of the song data.
- * The setting remains effective even after you power off and then on.

1 On the Select Menu screen of the SETUP mode, select "Digital In" and press the [ENTER/YES] key.

The current setting starts flashing (by default, "Off" is selected).

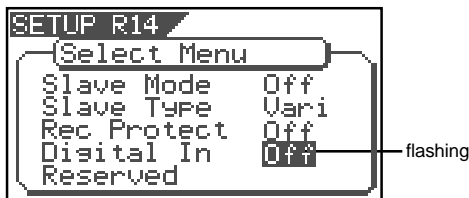

2 Use the [JOG] dial to select "On" or "Off", and press the [ENTER/YES] key.

If you select "On" and press the [ENTER/YES] key, a warning message appears on the display. By rotating the [JOG] dial, you can read the full text.

If you agree to the text of the message, press the [ENTER/YES] key again to make setting to "On".

3 Press the [EXIT/NO] key (or the [STOP] key) repeatedly until the VF80EX exits the SETUP mode.

<Notes>

- When "Digital In" is set to "On", "DIGI IN" is shown on the Normal screen. When the VF80EX is receiving a valid S/PDIF digital signal and locks to it, "DIGI IN" lights steadily. When the VF80EX is not receiving a valid S/PDIF digital signal, "DIGI IN" flashes. In such a case, check the connection to the external device, as well as the digital output setting of the external device.
- While "Digital In" is set to "On", entering the bounce, training or mastering mode automatically switches the "Digital In" setting to "Off". Therefore, to make digital recording again later, make the "Digital In" setting to "On" again.

Setting Bar/beat resolution mode ["J Resolution"]

Using the "J Resolution" menu item, you can select on/off of the bar/beat resolution mode. By default, the mode is set to "Off". By setting the mode to "On" and selecting the timebase on the screen to "bar/beat/clock", the value in the clock field is rounded off when assigning a position to a memory key. In other words, stored point data has beat accuracy. Using this function, you can store the IN, OUT, START, END or TO point on-the-fly with beat accuracy, which allows to make editing (copy, move, paste, etc.) with beat accuracy.

For example, we assume that the timebase on the screen is set to "bar/beat/clock" and you are going to store points at "001BAR 1 J 46CLK" and "002BAR 4 J 51CLK" as the START and END points, respectively. If "J Resolution" is set to "Off", the points are stored as they are above. If "J Resolution" is set to "On", the points are stored as below (note that we assume the time signature is set to 4/4).

001 bar 1 J 46 clk -> 001 bar 1 J 00 clk
(The clock value (46) is rounded down.)

002 bar 4 J 51 clk -> 003 bar 1 J 00 clk
(A clock value (51) is rounded up.)

- Default: Off
- Available options: On, Off
- * This setting is common to all programs on the same disc.
- * You cannot save the setting as a part of the song data.
- * The setting remains effective even after you power off and then on.

1 On the Select Menu screen of the SETUP mode, select "JResolution" and press the [ENTER/YES] key.

The current setting starts flashing (by default, "Off" is selected).

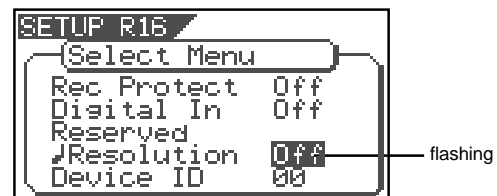

2 Use the [JOG] dial to select "On" or "Off", and press the [ENTER/YES] key.

The selected option is set.

3 Press the [EXIT/NO] key (or the [STOP] key) repeatedly until the VF80EX exits the SETUP mode.

Setting the MIDI device number ["Device ID"]

Using the "Device ID" menu item, you can set a device ID of the VF80EX, which is needed for controlling the VF80EX from a sequencer software application, etc. via MMC (MIDI Machine Control).

Note that the transmitting device ID of the VF80EX follows this setting. You can set a desired device ID between 00 and 99.

When the VF80EX receives a message for device ID [7F], the VF80EX recognizes the message and reacts to it regardless of the "Device ID" setting.

- Default: 00
- Available device IDs: 00 through 99
- * This setting is common to all programs on the same disc.
- * You cannot save the setting as a part of the song data.
- * The setting remains effective even after you power off and then on.

2 Use the [JOG] dial to select a desired MIDI device ID number, and press the [ENTER/YES] key.
The selected ID number is set.

3 Press the [EXIT/NO] key (or the [STOP] key) repeatedly until the VF80EX exits the SETUP mode.

1 On the Select Menu screen of the SETUP mode, select "Device ID" and press the [ENTER/YES] key.

The current setting starts flashing (by default, "00" is selected).

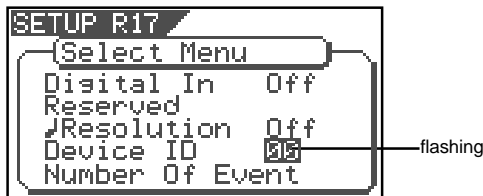

Checking the number of track events ["Number Of Event"]

From the "Number Of Event" menu item, you can check the number of events for each track.

A program on the VF80EX consists of "audio files" and "silent (0) files" for tracks (including additional tracks). Each audio or silent file is called an "event". This menu item shows the number of events on each track, which is, in other words, the total number of audio and additional files on each track. As described earlier, the VF80EX can manage up to 512 events per track on each program, which is enough in most cases even if you make very complicated editing (also remember that the VF80EX optimization function helps reducing the number of events). However, when you use the "24-hour recording" capability of the VF80EX and carry out a large number of recording and editing operations, you should mind the number of events does not exceed 512. In such a case, we recommend to check the number of events for each track using the "Number Of Event" menu item before recording or editing.

See "Event" on page 11 for details about audio files and events.

1 On the Select Menu screen of the SETUP mode, select "Number Of Event" and press the [ENTER/YES] key.

The display changes to show the "Number Of Event" screen, in which you can see the number of events currently existing on each track.

▼ indicates that invisible information exists under the screen. In the screen example below, "****" shows the number of events.

2 You can scroll the list to see the number of events on each track (1 through 24) by rotating the [JOG] dial.

3 Press the [EXIT/NO] key (or the [STOP] key) repeatedly until the VF80EX exits the SETUP mode.

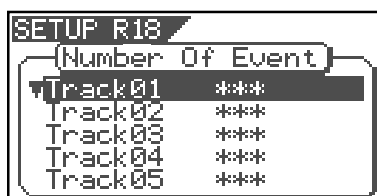

The Drive Format Information ["Drive Information"]

From the "Drive Information" menu item, you can check the format information of the current drive. If you have any trouble with your VF80EX and contact your nearest Fostex service station, this information is very important and helpful for us in giving quick service.

You can see the following drive information.

1. Manufacture/Model of the currently installed hard disk
2. Format method
3. Format type
4. Number of tracks available for recording/playback
5. Number of bits at formatting
6. Sampling frequency at formatting
7. Number of programs on the disk
8. Number of free blocks on the disk
9. Largest number of audio files/events among programs and the associated program number.
10. Total capacity of the drive
11. Remaining space of the drive
12. Software version at formatting

- 1 On the Select Menu screen of the SETUP mode, select "Drive Information" and press the [ENTER/YES] key.

The display changes to show the "Drive Information" screen, in which you can see the current drive information.

▼ indicates that invisible information exists under the screen.



- 2 You can scroll the list to see the item you want to check by rotating the [JOG] dial.

- 3 Press the [EXIT/NO] key (or the [STOP] key) repeatedly until the VF80EX exits the SETUP mode.

Fader Fix Mode Setting ["Fader Fix"]

By setting the "Fader Fix" menu item to "On", you can disable the operation of the track and master faders on the panel.

<Caution>

The fader fix mode is effective only when the "Fader Recall" menu item (described below) is set to "On".

- Default: Off
- Available Options: On or Off
- * This setting is common to all programs on the same disc.
- * You cannot save the setting as a part of the song data.
- * The setting remains effective even after you power off and then on.

- 2 Use the [JOG] dial to select "On" or "Off", and press the [ENTER/YES] key.

The selected option is set.

On	In all modes, the operation of controlling the track and master faders is ignored and does not change the sound level.
Off (default)	The operation of controlling the track and master faders reflects the sound level.

- 1 On the Select Menu screen of the SETUP mode, select "Fader Fix" and press the [ENTER/YES] key.

The current setting starts flashing (by default, "Off" is selected).

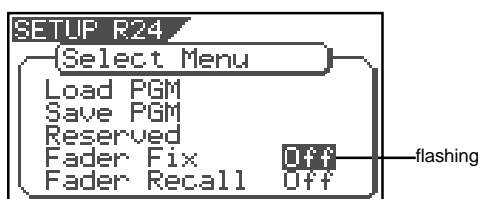

- 3 Press the [EXIT/NO] key (or the [STOP] key) repeatedly until the VF80EX exits the SETUP mode.

Fader Recall mode Setting ["Fader Recall"]

Using the "Fader Recall" menu item, you can select whether or not recalling the track and master fader settings when recalling a scene.

- Default: Off
- Available Options: Off, Track, Master, Trk&Mst
- * This setting is common to all programs on the same disc.
- * You cannot save the setting as a part of the song data.
- * The setting remains effective even after you power off and then on.

- 1** On the Select Menu screen of the SETUP mode, select "Fader Recall" and press the [ENTER/YES] key. The current setting starts flashing (by default, "Off" is selected).

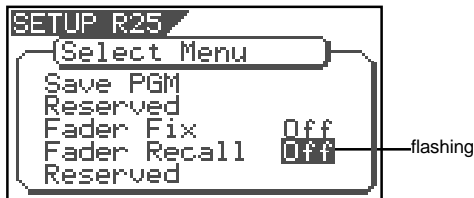

- 2** Use the [JOG] dial to select the desired option, and press the [ENTER/YES] key. The selected option is set.

Off (default)	When recalling a scene, the settings of track and master faders are not recalled. Therefore, the fader positions do not change from the positions before recalling the scene.
Track	When recalling a scene, the track fader settings are recalled, while the master fader setting is not recalled.
Master	When recalling a scene, the master fader setting is recalled, while the track fader settings are not recalled.
Trk & Mst	When recalling a scene, both the track and master fader settings are recalled.

- 3** Press the [EXIT/NO] key (or the [STOP] key) repeatedly until the VF80EX exits the SETUP mode.

Specifications (VF80EX)

(Digital Multitracker)

Model VF80EX

MIDI Implementation Chart

Date:
Version: V1.00

Function.....	Transmitted	Recognized	Remarks
Basic Default Channel Changed	X X	X X	
Mode Default Message Altered	X X *****	X X X	
Note Number: True Voice	X *****	X X	
Velocity Note ON Note OFF	X X	X X	
After Touch Key's Channel's	X X	X X	
Pitch Bend	X	X	
Control Change	X	X	
Program Change True #	X *****	X X	
System Exclusive	<input type="radio"/> (rem. 1)	<input type="radio"/> (rem. 2)	
Common : Quarter Frame : Song Position : Song Select : Tune	<input type="radio"/> <input type="radio"/> X X	<input type="radio"/> X X X	
System : Clock Real Time : Commands	<input type="radio"/> <input type="radio"/> (rem. 3)	X X	
Aux. Message : Local ON/OFF : All Notes OFF : Active Sense : Reset	X X X X	X X X X	
Notes	rem.1: MMC (Device ID=00~99, 127), MTC, Identity reply rem.2: MMC (Device ID=00~99, 127), MTC, Inquiry rem.3: START, STOP, CONTINUE		

Mode 1: OMNI ON, POLY
Mode 3: OMNI OFF, POLY

Mode 2: OMNI ON, MONO
Mode 4: OMNI OFF, MONO

: Yes
X: No

MMC Command List

Command list	Movement (Recorder)
01: STOP	STOP
02: PLAY	PLAY
03: DEFERRED PLAY	DEFERRED PLAY
04: FAST FORWARD	F FWD
05: REWIND	REWIND
06: RECORD STROBE	REC
07: RECORD EXIT	PUNCH OUT
09: PAUSE	STOP
40: WRITE	Refer to MMC Response/Information Field List
41: MASKED WRITE	Refer to MMC Response/Information Field List
42: READ	Refer to MMC Response/Information Field List
44: LOCATE	LOCATE to Setting Data
46: SEARCH	CUE/REVIEW (+/- 1~60 times)
47: SHUTTLE	CUE/REVIEW (+/- 1~60 times)
4C: MOVE	Refer to MMC Response/Information Field List
4D: ADD	Refer to MMC Response/Information Field List
4E: SUBTRACT	Refer to MMC Response/Information Field List

MMC Response/Information Field List	Command
01: SELECTED TIME CODE	READ/WRITE/MOVE/ADD/SUBTRACT
03: REQUESTED OFFSET	READ/WRITE
04: ACTUAL OFFSET	READ
08: GP 0	READ/WRITE/MOVE/ADD/SUBTRACT
09: GP 1	READ/WRITE/MOVE/ADD/SUBTRACT
0A: GP 2	READ/WRITE/MOVE/ADD/SUBTRACT
0B: GP 3	READ/WRITE/MOVE/ADD/SUBTRACT
0C: GP 4	READ/WRITE/MOVE/ADD/SUBTRACT
0D: GP 5	READ/WRITE/MOVE/ADD/SUBTRACT
0E: GP 6	READ/WRITE/MOVE/ADD/SUBTRACT
0F: GP 7	READ/WRITE/MOVE/ADD/SUBTRACT
48: MOTION CONTROL TALLY	READ
4C: RECORD MODE	READ/WRITE
4E: TRACK RECORD STATUS	READ
4F: TRACK RECORD READY	READ/WRITE/MASKED WRITE
51: RECORD MONITOR	READ/WRITE

Inquiry Message List

IDENTITY REQUEST: F0, 7E, <channel>, 06, 01, F7

IDENTITY REPLY: F0, 7E, <channel>, 06, 02, 51, 01, 00, 13, 05, **, **, **, **, F7

51 :Fostex ID
01, 00 :Device family code
13, 05 :Device family number VF80EX
****, **, **, **** :Software version

Maintenance

Cleaning the exterior

*** For normal cleaning, use a soft dry cloth.**

For stubborn dirt, moisten a cloth in diluted detergent, wring it out firmly, and wipe the dirt off. Then polish with a dry cloth. Never use solvents such as alcohol, thinner or benzene, since these will damage the printing and finish of the exterior.

Specifications

Recording/Reproducing

Recording Medium	: 3.5 inch, hard disk (E-IDE type)
Recording Format	: FDMS-3 (*)
Save/Load Format	: FDIO-1 (**)
Sampling Frequency	: 44.1kHz
Quantization	: 16-bit linear (Non expanded)
A/D Converter	: 20-bit 64 times, over sampling, Delta-Sigma
D/A Converter	: 24-bit 128 times, over sampling, Delta-Sigma
No. of Recording Track	: 8 real tracks + 16 additional tracks *2 tracks for simultaneous recording (Maximum)
Vari Pitch Control	: +/- 6%
Crossfade	: 10msec.
Recording/Reproducing Frequency	: 20Hz ~ 20kHz

Input/Output

Input A, B

Connector	: ø6mm Phone jack (Unbalanced) : XLR-3-31 type connector (Balanced)
Input Impedance	: 50kΩ or more (Unbalanced) : 1kΩ or more (Balanced)
Standard Input Level	: -50 ~ +4dBu
Phantom Power (XLR only)	: +48VDC (Setting of ON/OFF with PHANTOM switch)

HEADPHONE

Connector	: ø6mm TRS Phone jack
Load Impedance	: 10Ω ~ 50Ω
Output Level	: 20mW or more (at 32Ω)

STEREO OUT L, R

Connector	: ø6mm Phone jack
Load Impedance	: 10kΩ or more
Output Level	: -10dBV

S/P DIF DIGITAL IN

Connector	: COAXIAL
Format	: IEC 60958 (S/P DIF)

DIGITAL OUT

Connector	: COAXIAL
Format	: IEC 60958 (S/P DIF)

MIDI IN/OUT

Connector	: DIN 5 PIN
-----------	-------------

PUNCH IN/OUT

Connector	: ø6mm Phone jack (An optional FOOT SW Model 8051 can be connected.)
-----------	--

General

- Dimensions : 307 (W) x 108 (H) x 217 (D) mm
- Weight : Approx. 3.3kg
- Power Supply : 120VAC 60Hz, 230V~ 50/60Hz (AC inlet type)
- Power Consumption : 20W

Accessories

- : Owner's manual
- : Power Cable

* Fostex Disk Management System-3

** Fostex Data In Out-1

Specifications and appearance are subject to change without notice for product improvement.

Block Diagram

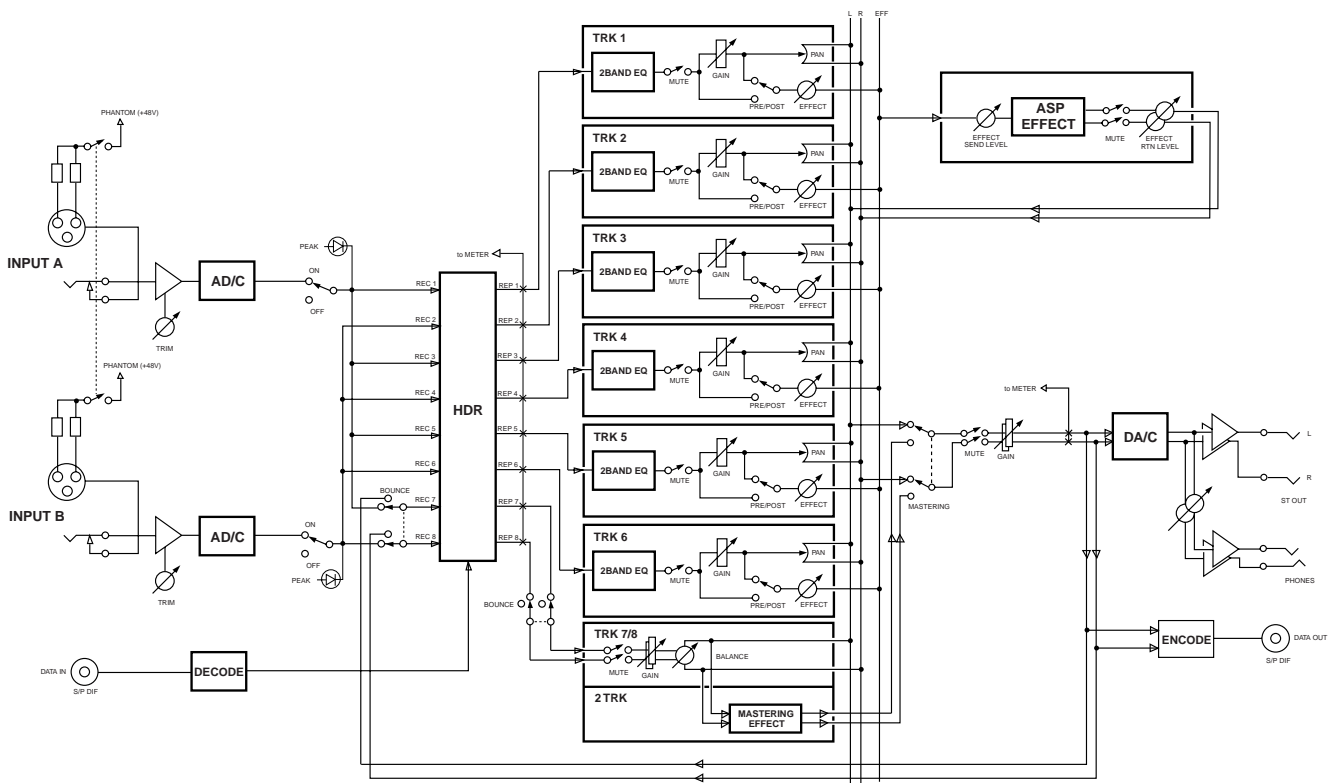

Block Diagram (when using the insert effect)

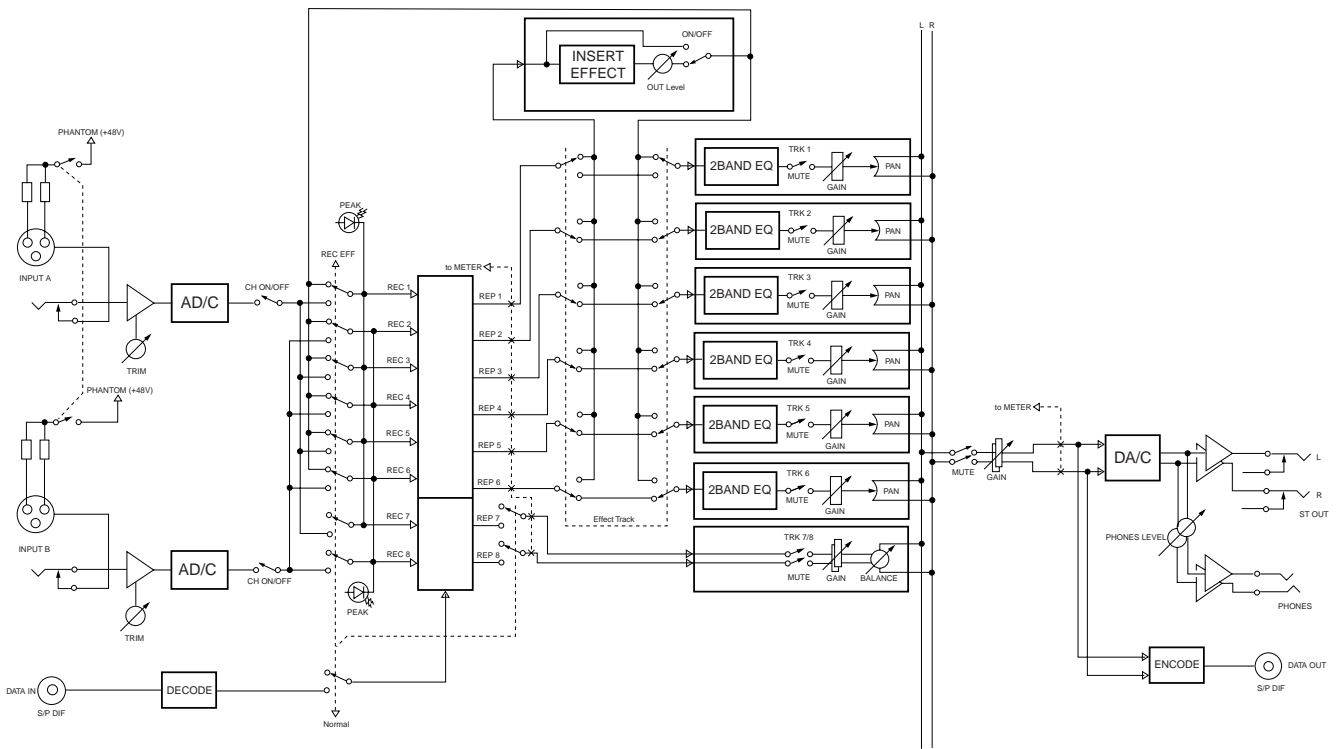

Dimensions

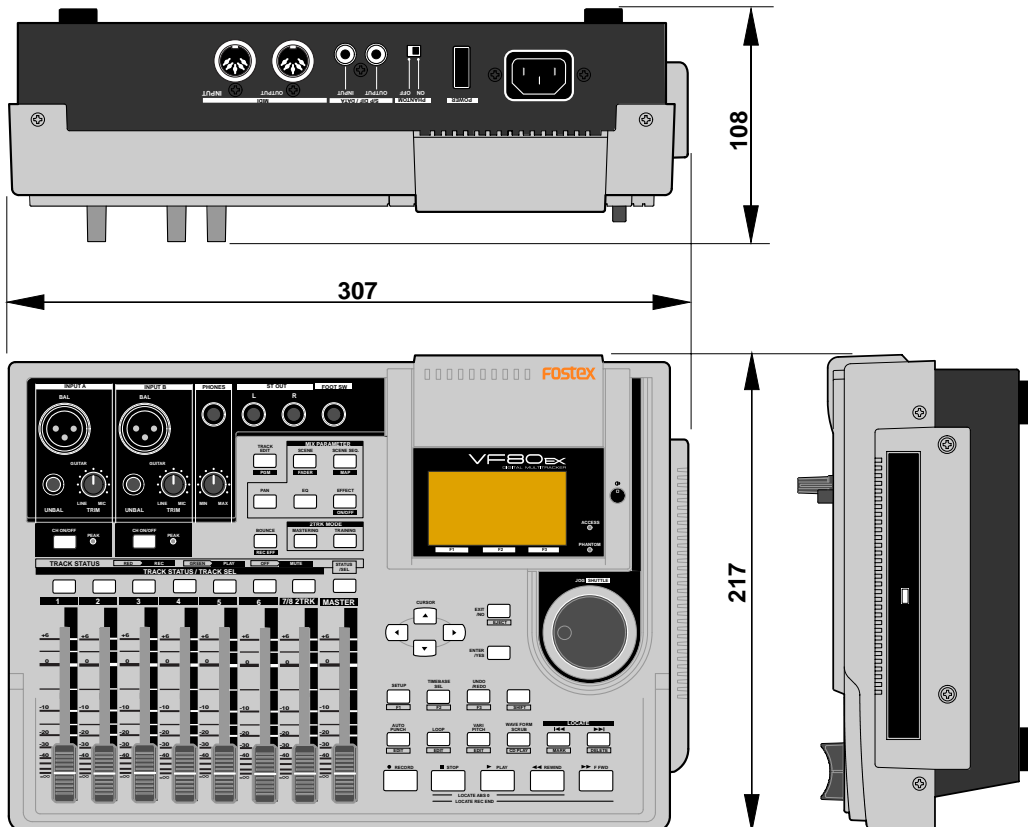

Declaration of EC Directive

This equipment is compatible with the EMC Directive (89/336/EEC) - Directive on approximation of member nation's ordinance concerning the electromagnetic compatibility and with the Low Voltage Directive (73/23/EEC) - Directive on approximation of member nation's ordinance concerning electric equipment designed to be used within the specified voltage range.

The Affect of Immunity on This Equipment

The affect of the European Specification EN61000-6-1 (coexistence of electromagnetic waves - common immunity specification) on this equipment are as shown below.

* In the electrical fast transient/burst requirements, surge, conducted disturbances by radio-frequency fields, power frequency magnetic field, radiate electromagnetic field requirements and static electricity discharging environment, this could be affected by generation of noise in some cases.

FOSTEX DISTRIBUTORS LIST IN EUROPE

* Including non-EU countries (as of October, 2003).

<AUSTRIA>

NAME: ATEC Audio-u. Videogeraete VertriebsgesmbH.
ADD: Im Winkel 5, A-2325 Velm, Austria
TEL: (+43) 2234-74004, FAX: (+43) 2234-74074

<BELGIUM>

NAME: General Audio
ADD: Albert Temmerstraat 21, 1731 Zellik, Belgium
TEL: (+32) 2-4630650, FAX: (+32) 2-4661500

<DENMARK>

NAME: SC Sound ApS
ADD: Malervej 2, DK-2630 Taastrup, Denmark
TEL: (+45) 4399-8877, FAX: (+45) 4399-8077

<FINLAND>

NAME: Noretron Oy Audio
ADD: P. O. Box 22, FIN-02631 Espoo, Finland
TEL: (+358) 9-5259330, FAX: (+358) 9-52593352

<FRANCE>

NAME: Sennheiser France
ADD: 128 bis, avenue Jean-Jaures, 94851 Ivry-sur-Seine
Cedex, France
TEL: (+33) 1 4987 0300, FAX: (+33) 1 4987 0324

<GERMANY>

NAME: Mega Audio GmbH
ADD: Stromberger Str. 32, D-55411 Bingen, Germany
TEL: (+49) 6721-94330, FAX: (+49) 6721-32046

<GREECE>

NAME: Bon Studio S. A.
ADD: 6 Zaimi Street, Exarchia, 106.83 Athens, Greece
TEL: (+30) 210-3809-605, 606, 607, 608
FAX: (+30) 210-3845-755, 210-3827-868

<ICELAND>

NAME: I. D. elf. electronic Ltd.
ADD: ARMULA 38 108 REYKJAVIK, ICELAND
TEL: (+354) 588 5010, FAX: (+354) 588 5011

<ITALY>

NAME: Proel S.p.A.
ADD: Zona Via Alla Ruenia, 37/43 64027-Sant'Omero
(Teramo), Italy
TEL: (+39) 0861-81241, FAX: (+39) 0861-887862

<THE NETHERLANDS>

NAME: IEMKE ROOS AUDIO B. V.
ADD: Kuiperbergweg 20, 1101 AG Amsterdam, The
Netherlands
TEL: (+31) 20-697-2121, FAX: (+31) 20-697-4201

<NORWAY>

NAME: Fitzpatrick
ADD: P. B. 4316 Nydalen, 0402 Oslo, Norway
TEL: (+47) 23 400 380, FAX: (+47) 23 400 389

<PORTUGAL>

NAME: Caius - Tecnologias Audio e Musica, Lda.
ADD: Praca do Bom Sucesso, No 61 Bom Sucesso Trade
Center, Escritorio 701/702, 4150-1460 Porto, Portugal
TEL: (+351) 22-608-06-10, FAX: (+351) 22-608-06-29

<SPAIN>

NAME: Letusa S. A.
ADD: C/Laguna, No 10, 28923 Alcorcon, Madrid, Spain
TEL: (+34) 91-4862800, FAX: (+34) 91-6414597

<SWEDEN>

NAME: TTS Scandinavia AB
ADD: Kavallerivagen 24, 172 48 Sundbyberg, Sweden
TEL: (+46) 8-59798000, FAX: (+46) 8-59798001

<SWITZERLAND>

NAME: Audio Bauer Pro AG
ADD: Bernerstrasse-Nord 182, CH-8064 Zurich, Switzerland
TEL: (+41) 1-4323230, FAX: (+41) 1-4326558

<UK>

NAME: SCV London
ADD: 40 Chigwell Lane, Oakwood Hill Industrial Estate,
Loughton, Essex IG10 3NY U.K.
TEL: (+44) 20-8418-0778, FAX: (+44) 20-8418-0624

Fostex[®]

FOSTEX CO.

3-2-35, Musashino, Akishima-shi, Tokyo, Japan 196-0021

FOSTEX AMERICA

15431, Blackburn Ave., Norwalk, CA 90650, U. S. A.